



# Deletional Analysis of the Rod Photoreceptor Cell Peripherin/RDS Carboxy-Terminal Region

SUSAN MULLER-WEEKS\*, KATHLEEN BOESZE-BATTAGLIA AND  
CATHERINE FITZGERALD

*Department of Molecular Biology, University of Medicine and Dentistry of New Jersey—School of Osteopathic Medicine and UMDNJ-GSBS-Stratford Division, 2 Medical Center Drive, Stratford, NJ 08084, U.S.A.*

*(Received 04 February 2002 and accepted in revised form 28 March 2002)*

The C-terminal region of peripherin/rds contains three predicted  $\alpha$ -helical domains. One of these domains, corresponding to amino acids 311–322, form an amphiphilic  $\alpha$ -helix previously shown to promote membrane fusion. The present studies were conducted to determine how the additional  $\alpha$ -helical regions of the peripherin/rds C-terminus affect complex formation with rom-1, glycosylation, intracellular localization and membrane fusion properties. Bovine peripherin/rds and rom-1 were epitope tagged with an amino-terminal FLAG-tag or amino-terminal hemagglutinin (HA)-tag, respectively, and cloned into the pCI-neo expression vector for transient transfection into COS cells. Similarly, four C-terminal peripherin/rds truncation mutants ( $\Delta 1$ ,  $\Delta 2$ ,  $\Delta 3$  and  $\Delta 4$ ), corresponding to deletions of -19, -29, -39 and -59 amino acids were designed to disrupt the  $\alpha$ -helical domains. Immunofluorescence microscopy and enzymatic digestions demonstrated that full-length peripherin/rds and the four C-terminal deletion mutants were localized to intracellular membranes and were all Endo-H sensitive. Western blotting and immunoprecipitation studies showed that the FLAG-tagged bovine peripherin/rds (full-length) was expressed as a 76 kDa dimer, which associates with HA-tagged rom-1 to form a higher order complex. The deletion mutants were also able to associate with rom-1. However, when analyzed using non-denaturing tricine electrophoresis, full-length peripherin/rds and the  $\Delta 1$ ,  $\Delta 2$  and  $\Delta 3$  mutants formed homo-oligomeric complexes, while the  $\Delta 4$  mutant appeared to form only homodimers suggesting a region upstream of amino acid 300 may be involved in C-terminal interactions. Membrane fusion was then evaluated using fluorescence resonance energy transfer (RET) techniques. Intracellular COS cell membranes containing full-length peripherin/rds fused with rod outer segment plasma membrane vesicles. This fusion was inhibited with the addition of a synthetic peptide (PP-5) corresponding to the fusion domain of peripherin/rds. In contrast, fusion was negligible with any of the C-terminal truncation mutants. Collectively, these results suggest that in addition to the fusion domain, other regions of the peripherin/rds C-terminus are required for fusion. Most interesting is the observation that the last 19 amino acids, a region downstream of the fusion peptide that is deleted in the  $\Delta 1$  mutant, appear to be necessary for fusion. This region corresponds to the epitope for anti-peripherin/rds monoclonal antibody 2B6, which is shown to partially inhibit peripherin/rds mediated membrane fusion.

© 2002 Elsevier Science Ltd.

*Key words:* rods; outer segments; membrane fusion; peripherin/rds; rom-1.

## 1. Introduction

The retinal degeneration slow or rds mouse is a model for a group of inherited human diseases known collectively as retinitis pigmentosa (van Nie et al., 1978). Mice homozygous for the rds mutation do not develop photoreceptor outer segments and exhibit a slow progressive loss of rods and cones (Sanyal and Jansen, 1981). The underlying defect is an insertion of a 9.2 kbp repetitive sequence element into a gene known as peripherin/rds (Travis et al., 1989). Subsequent studies have shown that mutations in the human peripherin/rds gene also cause a variety of retinal dystrophies including autosomal dominant retinitis pigmentosa and macular dystrophy (Kohl et al., 1998).

Peripherin/rds is a 346 amino acid integral membrane glycoprotein expressed exclusively in the outer segments of rod and cone cells (Connell and Molday, 1990; Travis et al., 1991). Within the photoreceptor disk rim, peripherin/rds is oriented such that both the N-terminus and C-terminus are exposed to the cytoplasm (Arikawa et al., 1992). The protein has four predicted transmembrane domains and consequently two intradiskal loops (D1 and D2). The D1 loop is located between the first and second transmembrane domains while the D2 loop, the larger of the two, is located between the third and fourth transmembrane domains. Peripherin/rds is highly conserved with amino acid identities of greater than 90% between species (Kedzierski et al., 1996). It has two potential N-linked glycosylation sites although only asparagine 229 is glycosylated in vivo (Kedzierski et al., 1999).

\* Author for correspondence. E-mail: [muller@umdnj.edu](mailto:muller@umdnj.edu)

In rod outer segment (ROS) disk membranes, peripherin/rds forms disulfide-linked homodimers, via cysteine residue 150 located within the D2 loop (Goldberg et al., 1998). A significant portion of these homodimers form disulfide-linked homotetrameric and octameric complexes (Loewen and Molday, 2000). Peripherin/rds homodimers also associate with homodimers of the related disk rim protein, rom-1 to form multisubunit complexes (Travis et al., 1991; Goldberg et al., 1995; Goldberg and Molday, 1996). Rom-1 is a 37 kDa, non-glycosylated structural homolog of peripherin/rds that is expressed in the rim region of rod disk membranes (Bascom et al., 1992; Moritz and Molday, 1996). Although the function(s) of peripherin/rds remains elusive, it is proposed to serve an important role in the structural maintenance of rod and cone outer segments (Travis et al., 1991; Bascom et al., 1992; Goldberg et al., 1995). This is directly supported by *in vitro* studies showing that expression of peripherin/rds confers a flattened morphology upon microsomal membranes (Wrigley et al., 2000). More recently, Poetsch et al. (2001) have shown that peripherin/rds interacts with glutamic acid rich proteins (GARP) associated with the  $\beta$ -subunit of the cGMP-gated channel located in ROS plasma membranes.

While the D-2 loop of peripherin/rds (the region containing the highest concentration of disease-linked mutations) has been well characterized, very little is known about this proteins' C-terminal domain. One postulated function for the peripherin/rds C-terminus is that of a membrane fusion protein. In ROS, membrane fusion events are necessary for both disk morphogenesis and shedding (Steinberg et al., 1980; Matsumoto and Besharse, 1995). Purified, native peripherin/rds has been shown to promote fusion of recombinant disk lipid vesicles with ROS plasma membrane vesicles (Boesze-Battaglia et al., 1998). The putative fusion domain is an amphiphilic  $\alpha$ -helical region located within the peripherin/rds C-terminus. Notably, a synthetic peptide (PP-5) corresponding to this 15 amino acid fusion domain, can mediate individual steps of membrane fusion including aggregation and membrane destabilization (Boesze-Battaglia et al., 1998, 2000).

In addition to the fusion domain, there are two other predicted  $\alpha$ -helical domains located within the peripherin/rds C-terminus. This region may not only be involved in membrane fusion processes, but is proposed to contain a ROS specific localization signal (based on green fluorescent protein (GFP)-fusion constructs) (Tam et al., 2001). Its importance is also illustrated clinically by several chain termination and frame-shift mutations that result in proteins lacking various portions of the C-terminus. Individuals that have inherited these mutations present with heterogeneous disease phenotypes including pattern dystrophy and vitelliform macular dystrophy (Felbor et al., 1997; Kohl et al., 1997). Here we employ a

well-characterized COS cell expression system to evaluate the contribution of the C-terminal  $\alpha$ -helices to the established biochemical properties of peripherin/rds. A series of C-terminal deletion mutants were generated and shown to retain the capacity to interact with rom-1, although none are able to promote membrane fusion. Collectively, these results suggest that along with the fusion domain, other  $\alpha$ -helical regions of the C-terminus contribute to the membrane fusion process. We propose that progressive deletion of the C-terminus abrogates the formation of a fusion competent peripherin/rds.

## 2. Materials and Methods

### *Generation of Peripherin/rds and Rom-1 Plasmid Constructs*

The open reading frames of peripherin/rds and rom-1 were isolated from bovine retinal mRNA using RT-PCR (Ausubel, 1999). Peripherin/rds primers were designed using the sequence provided by Connell and Molday (1990, Genbank accession J02884). To enable protein detection, the upper 5' primer was engineered with a 24-nucleotide sequence corresponding to an 8 amino acid FLAG epitope tag (5'-ATGGACTAGAAG-GACGACGACGACAAGGCGCTGCTCAAAGT-CAAATTT-3'). The lower 3' primer corresponded to the following sequence: 5'-CTTCAGTGTGCAGAGGG-GACT-3'. Similarly, rom-1 primers were designed using the sequence provided by Moritz and Molday (1996, Genbank accession U72027). The upper 5' primer was engineered with a 36-nucleotide sequence corresponding to a 13 amino acid hemagglutinin (HA) epitope tag (5'-ATGTGCTACCCTTACGACGTGCCT-GACTACGCCAGCCTGGCGCCGGTGTGCCCTGGTC-3'). The rom-1 lower 3' primer was 5'-CTAGGCCT-CAGGCAGACTCCTTGG-3'. All reactions were carried out for 35 cycles using an annealing temperature of 63°C. The resulting PCR products were purified, kinased and end-filled by standard procedures (Sambrook et al., 1989). The fragments were then ligated to Sma I-digested pCI-Neo vector (Promega, Madison, WI, U.S.A.) and verified by DNA sequencing.

To generate the peripherin/rds deletion mutants, four additional lower 3' primers were designed. These primers correspond to progressive deletions of the C-terminus and are presented below:

Deletion number	3' Lower PCR primer
$\Delta 1$	5' - TCACAGTCTTCTCACACTCTCCAGAAA - 3'
$\Delta 2$	5' - TCACTTCCAGGTCTCCGGCACGC - 3'
$\Delta 3$	5' - TCAAAGCCAGCCCTCACTCTCGCAC - 3'
$\Delta 4$	5' - TCAGTGCAGGTAGCGTAGCCCAA - 3'

Each 3' primer was used in conjunction with the FLAG-tagged peripherin/rds 5' primer to amplify the specific DNA fragments. All PCR reactions were

performed for 35 cycles using an annealing temperature of 60°C and peripherin/rds/pCI-Neo construct as template DNA. Following PCR, the fragments were manipulated as described above and ligated to Sma I-digested pCI-Neo vector. All plasmid constructs were verified by sequence analysis and purified by density gradient centrifugation (Sambrook et al., 1989).

#### *Cell Culture and Transfections*

COS cells were grown in Dulbecco's Modified Essential Media (DMEM) supplemented with 10% fetal bovine serum. The cells were maintained in a humidified atmosphere of 5.5% CO<sub>2</sub> at 37°C and split 1:3 every third or fourth day. Transfections were performed using Lipofectamine PLUS reagent (Invitrogen Life Technologies, Carlsbad, CA, U.S.A.) as directed by the manufacturer. Cells were seeded 1 day prior to transfection as follows; 1 × 10<sup>5</sup> cells per well in a six well plate, 1 × 10<sup>6</sup> cells/10 cm dish, or 3 × 10<sup>6</sup> cells/15 cm dish. The amount of plasmid DNA was likewise based on culture vessel size; 1 µg per well, 4 µg/10 cm dish, or 12 µg/15 cm dish. All cells were harvested 48 hr post-transfection.

#### *Immunolocalization and Immunoprecipitation Analysis*

Immunolocalization studies were performed as described previously (Caradonna et al., 1996). The M5 anti-FLAG monoclonal antibody (Sigma, St. Louis, MO, U.S.A.) was used at a concentration of 10 µg ml<sup>-1</sup> and the FITC-conjugated secondary antibody (Invitrogen Life Technologies, Carlsbad, CA, U.S.A.) was used at a 1:1000 dilution. The slides were viewed through a Zeiss Axioscope fluorescence microscope equipped with an FITC-filter.

For immunoprecipitation analysis, cell extracts were prepared in 1 ml of cold NP40 lysis buffer (50 mM Tris-HCl, pH 7.5; 0.1% NP-40; 250 mM NaCl; 50 mM NaF; 5 mM EDTA). The extracts were sonicated and then centrifuged at 13 000 *g* for 10 min at 4°C to remove insoluble material. Protein concentrations were determined using the Bio-Rad protein assay system as directed. Immunoprecipitation reactions (0.5 mg ml<sup>-1</sup>) were carried out as described previously (Muller-Weeks et al., 1998) with one modification; all washes were performed using NP40 lysis buffer. Again, the M5 anti-FLAG monoclonal antibody was used at a concentration of 10 µg ml<sup>-1</sup> and the anti-HA monoclonal antibody (Covance) was used at a 1:1000 dilution. Proteins recovered by immunoprecipitation were resolved by 10% SDS-PAGE and visualized by Western blotting.

#### *Denaturing and Non-denaturing Gel Electrophoresis*

SDS-PAGE was performed using the method of Laemmli (1970). Cell extracts were denatured by adding an equal volume of 2× SDS-PAGE sample

buffer (100 mM Tris-HCl, pH 6.8; 200 mM DTT; 4% SDS; 0.2% bromophenol blue; 20% glycerol) in the presence (reducing) or absence (non-reducing) of 5% beta-mercaptoethanol. The samples were heated to 85°C for 10 min and loaded directly onto a 10% SDS-polyacrylamide gel. Non-denaturing tricine polyacrylamide gel electrophoresis (10%) was performed by omitting SDS from the system described by Schagger and von Jagow (1987). In this case, the samples were prepared in the absence of BME and were not heated prior to loading. Gels were run at 30 mA for 2 hr.

#### *Western Blotting and Enzymatic Deglycosylation Studies*

Western blotting was performed according to the procedure of Towbin et al. (1979). Antibody binding and wash conditions were as previously described (Caradonna et al., 1996). Protein bands were visualized using Sigma Fast BCIP/NBT (5-Bromo-4-Chloro-3-Indolyl phosphate/ Nitro blue tetrazolium) substrate as directed.

Deglycosylation of peripherin/rds was performed using endoglycosidase H (Endo H) as outlined by New England Biolabs (Beverly, MA, U.S.A.). Initially, 2 µl of denaturing buffer (50 mM sodium citrate, pH 5.5) were added to the extracts in a 15 µl reaction. The extracts were denatured by heating to 100°C for 10 min. Subsequently, 1/10th volume of 10× G5 buffer (0.5% SDS; 1% β-mercaptoethanol) and 1 U of endoglycosidase H were added and the reactions were incubated at 37°C overnight. Control extracts were also prepared as described but lacked the enzyme.

#### *Preparation and Labelling of ROS Membranes*

Retinal ROS membranes were isolated from 50 frozen, dark-adapted bovine retinas (J.A. Lawson, Lincoln, NE, U.S.A.). Disk membranes and plasma membrane vesicles were isolated using ricin-agarose and differential sucrose gradient centrifugation as described (Boesze-Battaglia and Albert, 1989). The ROS plasma membranes were eluted from the ricin-agarose pellet with 1 M galactose in 0.1 M sodium borate, pH 8.5. Both ROS plasma membrane vesicle fractions and the isolated disk membranes were washed with 10 mM Hepes, 1.0 mM EGTA. The plasma membrane vesicles were resuspended in 500 µl of 10 mM Hepes, pH 7.4 and used within 24 hr of isolation. All manipulations were performed under dim red light.

The phospholipid concentration of both ROS disk and plasma membrane samples was determined as described by Bartlett (1959) and modified by Litman (1973). Disk membranes were labelled with octadecylrhodamine B chloride (R<sub>18</sub>, Molecular Probes, Junction City, OR, U.S.A.) at a concentration of 1 mol% relative to total phospholipid. Plasma membrane vesicles were similarly labelled with

5-(*N*-octadecanoyl) aminofluorescein ( $F_{18}$ , Molecular Probes, Junction City, OR, U.S.A.). Labelling was carried out in a minimum volume of ethanol for 30 min at room temperature as described (Boesze-Battaglia and Yeagle, 1992). Labelled membranes were separated from unincorporated  $R_{18}$  or  $F_{18}$  by passing the samples through a Sephadex G50 column and eluting with 100 mM NaCl, 10 mM glycine pH 7.5.

#### *Preparation and Labelling of COS Intracellular Membranes*

COS cell intracellular membranes were isolated essentially as described by Oprian (1993). Briefly, cell pellets were resuspended in 600  $\mu$ l Tris–MgCl<sub>2</sub> buffer (10 mM Tris–HCl pH 7.2, 2 mM MgCl<sub>2</sub>, and 10 mM glucose) and lysed by passage through a 26-gauge needle two times. The resulting lysate was layered on a 3.8 ml cushion of 37% W/V sucrose in Tris–MgCl<sub>2</sub> buffer and centrifuged at 18 000 rpm for 20 min at 10°C (XL70 Ultra Centrifuge, SW 60 rotor, Beckmann Instrument, Papo Gilo, CA, U.S.A.). The intracellular membranes were collected in a 500  $\mu$ l volume and an equal volume of Tris–MgCl<sub>2</sub> buffer was added to dilute the sucrose. Phosphate assays were performed to determine the total phospholipid content of the intracellular membranes. The membranes were then labelled with  $F_{18}$  as described above. A total volume of 3 ml of labelled membrane was collected from the Sephadex G50 column.

#### *Resonance Energy Transfer Fusion Assays*

The fusion between  $R_{18}$ -labelled ROS plasma membrane vesicles and  $F_{18}$ -labelled membranes (ROS disk or intracellular COS) was measured using a well-characterized resonance energy transfer (RET) assay (Struck et al., 1981; Partearroyo et al., 1994). The fusion assays were performed at room temperature on a Perkin-Elmer LS 50B spectrofluorometer (Gaithersburg, MD, U.S.A.) equipped with a 96 well plate reader. Fusion was initiated with addition of  $R_{18}$ -labelled plasma membranes (final phospholipid concentration = 0.20 nM) to  $F_{18}$ -labelled membranes (final phospholipid concentration = 0.40 nM) already present in the well. Fluorescence intensity was measured at  $\lambda_{\text{ex}} = 460$  nm ( $F_{18}$  excitation) and at  $\lambda_{\text{em}} = 524$  nm ( $F_{18}$  emission) and  $\lambda_{\text{em}} = 592$  nm ( $R_{18}$  emission) over a 2 min period. There was no additional change in  $R_{18}$  fluorescence for 30 min. The extent of fusion ( $\Delta R \times 100$ ) was calculated as a percent change in  $R_{18}$  intensity over time as described previously (Partearroyo et al., 1994). The change in  $R_{18}$  intensity at a given time ( $\Delta R$ ) was computed as follows:

$$\Delta R = (I_{592}/I_{524} + I_{592})_T - (I_{592}/I_{524} + I_{592})_I,$$

where  $I_{524}$  and  $I_{592}$  are the fluorescence intensities at 524 and 592 nm, respectively. The subscripts T and I

represent a given time point and the initial time point of each sample, respectively. The extent of fusion (i.e., percent change in  $R_{18}$ ) was determined by multiplying each  $\Delta R$  value by 100 and this value was normalized to the calculated extent of fusion observed between  $F_{18}$ -labelled disks and  $R_{18}$ -labelled plasma membrane. This latter value was set as 100% and all extents of fusion ( $\Delta R \times 100$ ) were normalized to this standard. The  $\Delta R \times 100$  value obtained with mock-transfected cells was routinely subtracted from  $\Delta R \times 100$  of the samples. This value was variable, accounting for 25–40% of  $\Delta R$  measured for peripherin/rds expressing cells. The final Ca<sup>2+</sup> concentration in all assays was 100 nM. Fusion could be inhibited with the addition of EDTA at a final concentration of 10 mM.

For specificity studies,  $F_{18}$ -labelled COS intracellular membranes were preincubated with PP-5 (72.5 nM) at 37°C for 20 min prior to the addition of  $R_{18}$ -labelled ROS plasma membrane. The sequence of the PP-5 peptide is H<sub>2</sub>N-V-P-E-T-W-K-A-F-L-E-S-V-K-K-L-COOH.

### 3. Results

#### *Construction and Expression of Peripherin/rds Deletion Mutants*

The peripherin/rds C-terminus is a 64 amino acid extradiskal domain that spans amino acid residues 282–345. This region is highly conserved (78% amino acid identity) between human, bovine, canine, feline and rodent species suggesting a functional importance. Chou-Fasman and Robson-Garnier analyses of the peripherin/rds C-terminus predict three  $\alpha$ -helical regions that are labelled 1, 2 and 3 in Fig. 1. To evaluate the functional significance of these  $\alpha$ -helical domains, a series of C-terminal truncation mutants were constructed. The deletion endpoints were selected using the predicted secondary structural analysis (Fig. 1). The  $\Delta 1$  mutant, removes residues 326–345, corresponding to the third predicted  $\alpha$ -helical region. The  $\Delta 2$  mutant, deletes residues 317–345, truncating the second  $\alpha$ -helical region or fusion peptide domain (Boesze-Battaglia et al., 1997, 1998). The  $\Delta 3$  mutant removes residues 307–345, thus eliminating the entire fusion domain. Finally, the  $\Delta 4$  mutant truncates the entire C-terminus (residues 288–345) encompassing all three  $\alpha$ -helical regions. Of note, both the  $\Delta 2$  and  $\Delta 4$  mutants approximate disease-linked mutations shown to co-segregate with retinal degenerative diseases (Felbor et al., 1997; Kohl et al., 1997).

The full-length peripherin/rds and all mutants were engineered with an amino-terminal FLAG-epitope tag to facilitate detection. Following transient transfections into COS cells, protein expression was confirmed by immunohistochemical localization using monoclonal antibody against the FLAG-tag (M5, Sigma, St. Louis, MO, U.S.A.) and FITC-conjugated secondary

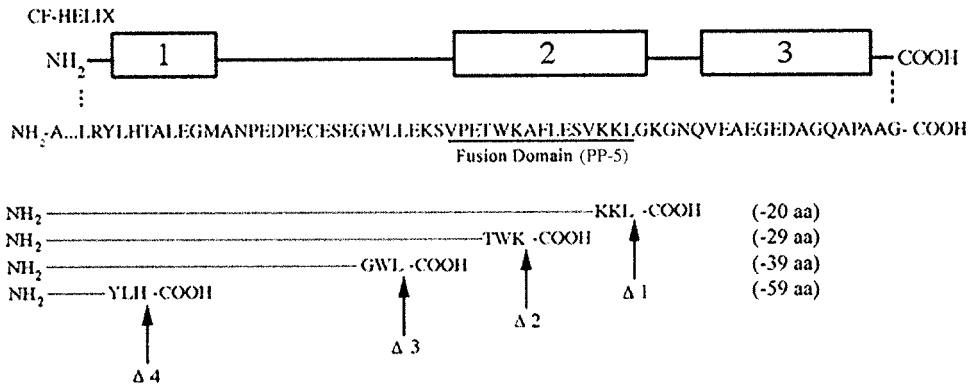

FIG. 1. Schematic representation of the peripherin/rds C-terminus and deletion mutants. Amino acid sequence of the peripherin/rds C-terminus is presented (residues 282–345). Chou-Fasman and Robison-Garnier analyses of the region reveals three,  $\alpha$ -helical regions that are denoted by  $\square$  and numbered 1, 2 and 3. Helix 2 is the previously characterized fusion domain and the corresponding amino acid sequence is underlined. This sequence also corresponds to the peptide referred to as PP-5. Four C-terminal deletion mutants were constructed to disrupt the  $\alpha$ -helical structures and are denoted  $\Delta 1$ – $\Delta 4$ . Deletion endpoints are marked with an arrow and the length of each deletion is indicated on the right.

antibody. The full-length, FLAG-tagged peripherin/rds is localized to the internal membranes of COS cells (Fig. 2(A), panel 1). Importantly, control transfections using pCI-neo vector alone are negative for specific peripherin/rds immunoreactivity (Fig. 2(A), compare panels 1 and 2). These results are consistent with those previously reported by Goldberg et al. (1995) for heterologously expressed peripherin/rds. Immunofluorescent localization of mutants  $\Delta 2$  and  $\Delta 4$  shows that the staining pattern is unchanged, remaining confined to the intracellular membranes (Fig. 2(A), panels 3 and 4). While it appears that the  $\Delta 4$  mutant may be expressed at higher levels (as compared with wild-type and  $\Delta 2$ ), Western blot analysis described below, demonstrates that it is not the case. Identical results were obtained for mutants  $\Delta 1$  and  $\Delta 3$  (data not shown).

Peripherin/rds expression was also evaluated by Western blot analysis using equivalent amounts of protein extract (25  $\mu$ g) derived from each transfected sample. As shown in Fig. 2(B), the full-length peripherin/rds and deletion mutants are expressed to approximately equal levels and can be readily detected using the FLAG-epitope tag. Full-length peripherin/rds migrates as a 38 kDa protein. This is slightly larger than the native peripherin/rds purified from ROS owing to the presence of the 1 kDa FLAG-tag. Molecular weights of the peripherin/rds mutants are reduced accordingly, ranging from 36 ( $\Delta 1$ ) to 31.5 kDa ( $\Delta 4$ ). It is also apparent that the peripherin/rds proteins resolve as doublets or possibly, as triplets. This is most likely due to the presence of both glycosylated and non-glycosylated forms. Others have observed similar doublet patterns under both in vivo (Boesze-Battaglia et al., 1997) and in vitro conditions (Wrigley et al., 2000). Collectively, these results suggest that the epitope tag does not interfere with protein expression or localization. In addition, progressive deletions of the C-terminus do not signifi-

cantly alter protein expression levels or cellular localization in the COS cell system.

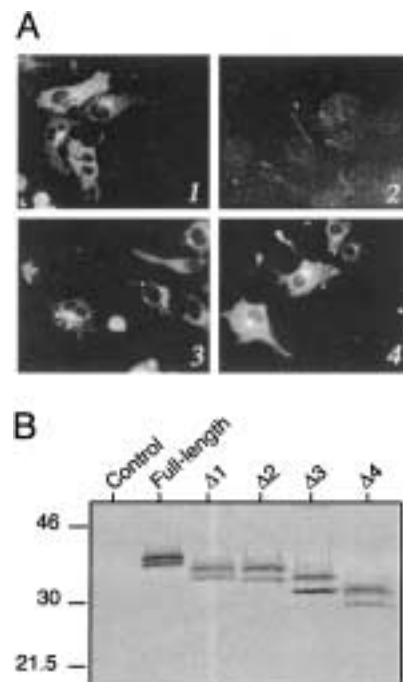

FIG. 2. Expression of the peripherin/rds constructs in COS cells. (A) Immunofluorescent localization using M5 anti-FLAG primary antibody and FITC-labelled secondary antibody. Cells were transiently transfected with the full-length peripherin/rds (panel 1),  $\Delta 2$  (panel 3) and  $\Delta 4$  (panel 4) constructs. Panel 2 shows that no immunofluorescence is detected in control cells transfected with pCI-Neo vector alone. (Note: The exposure time for panel 2 was increased in order to visualize cell structure since no specific fluorescence is detectable.) (B) Western blot analysis of full-length peripherin/rds and each deletion mutant ( $\Delta 1$ – $\Delta 4$ ). Extracts (25  $\mu$ g) from transiently transfected COS cells were fractionated by 10% SDS-PAGE under reducing conditions. The proteins were analysed by Western blotting using M5 anti-FLAG antibody. Molecular weight standards in kilodaltons are indicated on the left.

### Biochemical Characterization

The consequences of these C-terminal mutations on several well-established biochemical properties of peripherin/rds were then examined. These features include: (1) glycosylation, (2) association with rom-1 and (3) the ability to form higher order complexes. Peripherin/rds contains three possible N-linked glycosylation sites. In ROS, peripherin/rds is glycosylated at a single site, asparagine 229, located within the D2 intradiskal loop (Kedzierski et al., 1999). Goldberg et al. (1995) have shown that heterologously expressed peripherin/rds is incompletely glycosylated with both modified and unmodified forms present in extracts. To examine the effects of the C-terminal deletions on glycosylation, extracts prepared from transfected COS cells were treated with endoglycosidase H (Endo-H) as shown in Fig. 3. In untreated extracts (– lanes), peripherin/rds migrates as doublets (full-length,  $\Delta 1$  and  $\Delta 2$ ) or triplets ( $\Delta 3$  and  $\Delta 4$ ). Upon Endo-H treatment (+ lanes) however, all samples resolve as a single, lower molecular weight band. An HA-tagged Rom-1 was also included in this analysis and there was no apparent change in the presence or absence of Endo-H treatment indicating that it is not glycosylated in this system (data not shown). The glycosylation pattern associated with full-length peripherin/rds and mutants  $\Delta 1$  and  $\Delta 2$  is consistent with previous results (Goldberg et al., 1995) and indicates that removing the terminal 29 amino acids does not markedly interfere with glycosylation in this system. Interestingly, there is a third, higher molecular weight band identifiable in mutants  $\Delta 3$  and  $\Delta 4$ , which suggests the use of alternate glycosylation sites.

Peripherin/rds has been shown to complex non-covalently with a non-glycosylated homolog, rom-1 (Bascom et al., 1992). The contribution of the peripherin/rds C-terminus to this complex formation was determined by co-immunoprecipitation analysis using extracts from cells co-transfected with each peripherin/rds construct ( $\Delta 1$ ,  $\Delta 2$ ,  $\Delta 3$ , and  $\Delta 4$ ) and rom-1. For detection purposes, rom-1 was engineered with a HA-tag and cloned into pCI-Neo. Extracts prepared from COS cells co-transfected with the

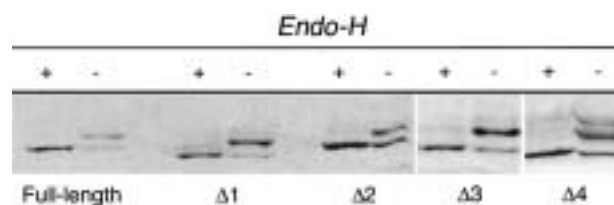

FIG. 3. Enzymatic deglycosylation studies. Extracts (25  $\mu$ g) prepared from transiently transfected COS cells were treated with Endo H (+) or left untreated (–) as indicated. Proteins were fractionated by 10% SDS–PAGE under reducing conditions and transferred to nitrocellulose for Western blot analysis using the anti-FLAG M5 antibody. Each construct name is indicated below the lanes.

individual peripherin/rds constructs and rom-1 were immunoprecipitated using anti-FLAG antibody (detects peripherin/rds). The products were separated by 10% SDS–PAGE and analysed by Western blotting with the anti-HA antibody (detects rom-1). Fig. 4(A) shows that full-length peripherin/rds and each of the mutants are able to co-precipitate the 39 kDa HA-tagged rom-1 protein. Control reactions are presented in Fig. 4(B). Rom-1 is not detected in FLAG-immunoprecipitates from mock-transfected cells or cells transfected with peripherin/rds or rom-1 individually (Fig. 4(B), lanes 1–3). In a reciprocal experiment, all of the anti-HA immunoprecipitates were shown to contain peripherin/rds (data not shown). Together these results show that removal of the peripherin/rds C-terminus does not eliminate its ability to interact with rom-1.

Native peripherin/rds also forms covalently linked homodimers, tetrameric and higher order oligomeric complexes (Goldberg et al., 1995; Loewen and Mol-day, 2000). Of particular significance are recent studies by Boesze-Battaglia et al. (2000) showing that a synthetic peptide corresponding to the peripherin/rds fusion domain (PP-5) can assume a homotetrameric state mediated through non-covalent interactions between the  $\alpha$ -helices. This suggested that the C-terminus of peripherin/rds may participate in the formation of homotetramers (oligomers) through non-covalent interaction. We assessed the ability of full-length peripherin/rds and each deletion mutant to assume dimeric and oligomeric forms using non-denaturing tricine gel electrophoresis. The proteins were visualized by Western blotting with FLAG antibody and the results are presented in Fig. 5. Full-length peripherin/rds, as well as peripherin/rds co-transfected with rom-1 predominantly form dimeric (approximately 80 kDa) and higher order oligomeric ( $\geq 160$  kDa) complexes. The same is evident for mutants  $\Delta 1$  and  $\Delta 2$ . Interestingly, while mutant  $\Delta 3$  is likewise able to form dimeric and higher order complexes, a significant monomeric band is also visible. The  $\Delta 4$  mutant is present exclusively in monomeric and dimeric forms and is apparently unable to efficiently form higher order complexes.

### Analysis of Peripherin/rds Dependent Fusion

Full-length bovine peripherin/rds has been shown to promote membrane fusion. The fusion domain has been localized to residues 311–325 within the C-terminus of the protein. To investigate how the predicted secondary structural domains within the C-terminus contribute to membrane fusion, the peripherin/rds deletion mutants were studied for their ability to promote membrane fusion. Using a RET method (Struck et al., 1981; Partearroyo et al., 1994), the fusion between intracellular COS cell membranes containing the expressed peripherin/rds proteins and bovine ROS plasma membrane vesicles was measured.

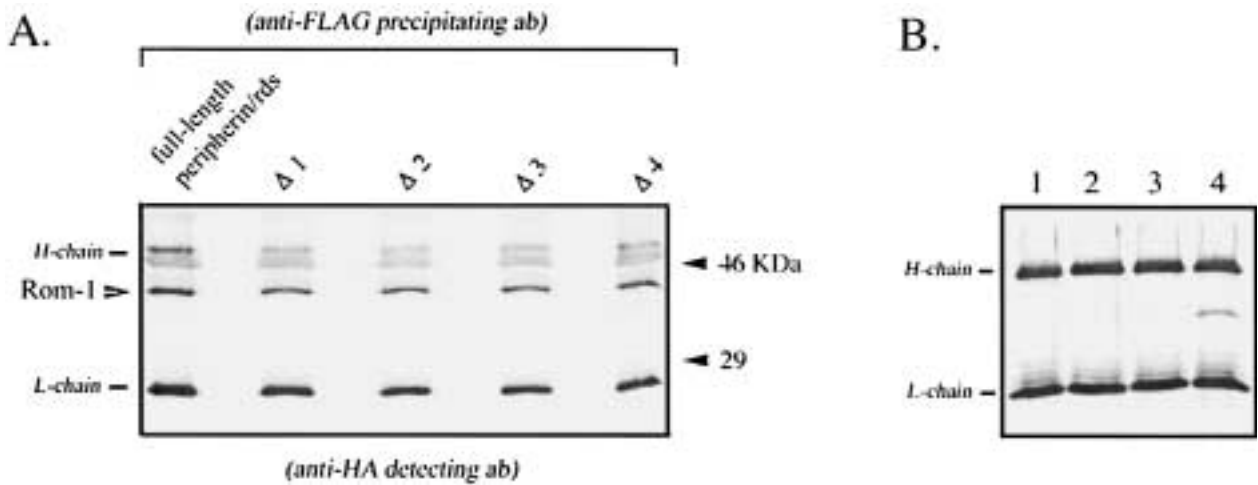

FIG. 4. Immunoprecipitation of peripherin/rds and rom-1 complexes. (A) Extracts ( $0.5 \text{ mg ml}^{-1}$ ) were prepared from COS cells transiently co-transfected with rom-1 plus the indicated constructs and immunoprecipitated using the M5 anti-FLAG antibody (detects peripherin/rds). The immunoprecipitates were fractionated by 10% SDS-PAGE and then analyzed by Western blotting using the anti-HA monoclonal antibody (detects rom-1). Molecular weight markers are indicated on the right and the location of antibody heavy and light chains are indicated on the left. (B) Control reactions showing the absence of rom-1 staining in immunoprecipitates from mock-transfected cells and cells transfected individually with rom-1 and peripherin/rds. Immunoprecipitation reactions and Western blotting were performed as described in (A), however, fractionation was by 12.6% SDS-PAGE. Lanes: (1) mock-transfected COS cells; (2) cells transfected with HA-rom-1; (3) cells transfected with FLAG-peripherin/rds; (4) cells co-transfected with HA-rom-1 and FLAG-peripherin/rds.

In this assay, each membrane species is labelled with a distinct fluorescent probe ( $F_{18}$  or  $R_{18}$  as described in the 'Materials and Methods'). As the membranes fuse, the lateral diffusion of the fluorescent probes within the lipid bilayer allows them to come in close proximity. This causes energy to be transferred from  $F_{18}$  (excited at 460 nm) to  $R_{18}$ , thereby indirectly exciting  $R_{18}$ . As shown in Fig. 6(A), when  $R_{18}$ -

labelled ROS plasma membrane vesicles are mixed with  $F_{18}$ -labelled COS cell membranes isolated from cells expressing the full-length peripherin/rds, an increase in  $R_{18}$  (solid line) and a decrease in  $F_{18}$  (dashed line) fluorescence intensity is observed. Notably, the increase in fluorescence was specific for only peripherin/rds containing COS cell membranes; when COS cells were transfected with rom-1 alone, no fusion was detected (data not shown). The increase in  $R_{18}$  fluorescence intensity was quantitated as described in the 'Materials and Methods' and normalized to maximal fusion. Maximal fusion is designated as that between  $R_{18}$ -labelled plasma membrane vesicles and  $F_{18}$ -labelled disk membranes (containing native peripherin/rds) (Fig. 6(B), bar 1). Fusion mediated by COS cell membranes containing full-length peripherin/rds is presented in Fig. 6(B), bar 2. All assays were performed using equivalent amounts of phospholipid (0.40  $\mu\text{M}$ ) and peripherin/rds expression was verified by Western blot analysis as shown in the inset. To confirm the specificity of the fusion as that due to peripherin/rds, the  $F_{18}$ -labelled COS cell intracellular membranes were treated with PP-5, a synthetic peptide, previously shown to inhibit disk-plasma membrane and peripherin/rds LUV-plasma membrane fusion. The addition of PP-5 resulted in a decrease in the percent change in  $R_{18}$  fluorescence, suggesting inhibition of membrane fusion (Fig. 6(C)). Importantly, the addition of bradykinin or PP-1 (a synthetic peptide to the N-terminal domain of peripherin/rds (Boesze-Battaglia et al., 1997)) had no effect on fusion. The concentration of PP-5 added is

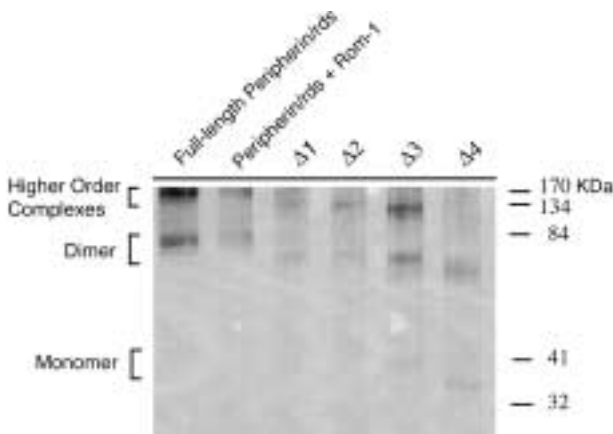

FIG. 5. Non-denaturing electrophoresis of full-length peripherin/rds and the deletion mutants. Extracts (30  $\mu\text{g}$ ) from cells transiently transfected with the indicated constructs were fractionated by 10% non-denaturing tricine gel electrophoresis. The proteins were transferred to nitrocellulose for Western blotting using anti-FLAG M5 monoclonal antibody. Monomeric, dimeric and higher order complex protein forms are indicated by brackets on the left. Molecular weight markers in kilodaltons are indicated on the right.

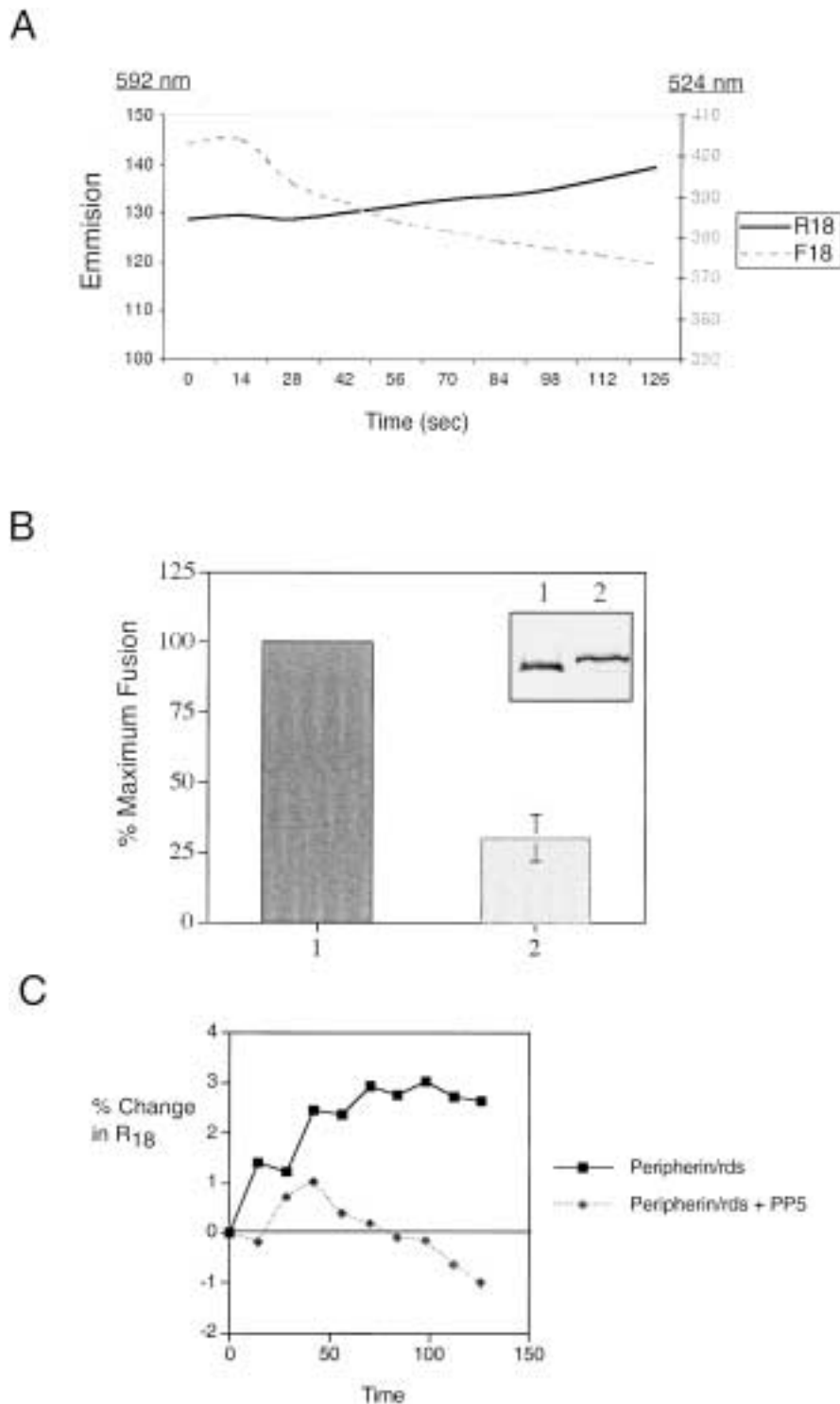

FIG. 6. Resonance energy transfer from  $F_{18}$  to  $R_{18}$ . (A) Presented above is a representative scan of the increase in  $R_{18}$  fluorescence emission at 592 nm (solid line) and the concomitant decrease in  $F_{18}$  fluorescence emission at 524 nm (dashed line) when  $F_{18}$ -labelled COS cell membranes containing peripherin/rds fuse with  $R_{18}$ -labelled ROS plasma membrane. The excitation wavelength is 460 nm. (B) Maximal fusion between  $R_{18}$ -labelled ROS plasma membrane and  $F_{18}$ -labelled COS cell membranes containing peripherin/rds or  $F_{18}$ -labelled disk membranes. The RET assay was performed as described in the 'Materials and Methods' and maximal percent fusion was calculated. Western blot analysis was also performed to confirm peripherin/rds expression in both samples (shown in inset). Inset, lane 1 disk membrane peripherin/rds; Western blot probed with monoclonal antibody 2B6 and lane 2, FLAG-tagged peripherin/rds in COS cell membranes; Western blot probed with anti-FLAG antibody. (C) The percent change in  $R_{18}$  fluorescence over time (in sec) upon energy transfer when  $R_{18}$ -labelled ROS plasma membranes are mixed with  $F_{18}$ -labelled COS cell membranes, in the presence [—◆—] and absence [—■—] of PP-5.



equal to the amount that inhibits fusion in model membrane studies.

A comparison of the percent maximal fusion between ROS plasma membranes and COS cell membranes expressing either the full-length or the four peripherin/rds deletion mutants can be seen in Fig. 7. In contrast to the full-length peripherin/rds, very little to no fusion was detectable with any of the four C-terminal deletion mutants. These values are in fact equivalent or below those obtained with mock-transfected cells. Routinely, the fluorescence observed with the mock-transfected samples corresponded to 2–3 % of maximal fusion and importantly no increase in fluorescence intensity was observed over the time course of the experiments with these cells. This inability to promote fusion is not due to the level of protein expression, since all membranes contained similar levels of expressed protein as shown in the inset of Fig. 7. Together these results suggest that none of deletion mutants contained the minimal structural requirements necessary to promote fusion at a level consistent with that of the full-length protein.

#### 4. Discussion

The results presented herein confirm and expand upon those reported by Goldberg et al. (1995). As described previously, peripherin/rds expressed in COS cells localizes to intracellular membranes, is glycosylated, forms heterotetramers with rom-1, and can form homodimers and homotetramers (Goldberg et al., 1995; Loewen and Molday, 2000). Our results extend

these findings by showing that peripherin/rds expressed in COS cells can function as a fusion protein by promoting fusion between COS cell membranes containing peripherin/rds and vesicles prepared from ROS plasma membranes. The characteristics of fusion between COS cell membranes and ROS plasma membrane vesicles are identical to those observed with the native disk membranes and purified peripherin/rds. Specifically, it is dependent upon nanomolar levels of calcium and can be inhibited by addition of PP-5, the synthetic peptide mimicking the proposed fusion domain of peripherin/rds. Moreover, it is specific for ROS plasma membrane as the target (data not shown), observations which suggest that the fusion event is indeed dependent upon the presence of peripherin/rds in the membranes and is not mediated by any of the other putative fusion proteins likely to also be present in COS intracellular membranes.

The present experiments were conducted to evaluate the role of the C-terminal  $\alpha$ -helices of peripherin/rds. To facilitate protein detection, an N-terminal FLAG epitope tagged peripherin/rds construct was generated for expression in COS cells. Importantly, our data show that the presence of the N-terminal epitope tag does not alter the expression, or the localization of peripherin/rds to intracellular membranes. As expected, the FLAG-tagged peripherin/rds formed either homo-oligomers or hetero-oligomers with rom-1. The presence of the N-terminal epitope tag also did not alter the fusogenic function of peripherin/rds.

Progressive deletion of the peripherin/rds C-terminus did not appear to alter significantly protein

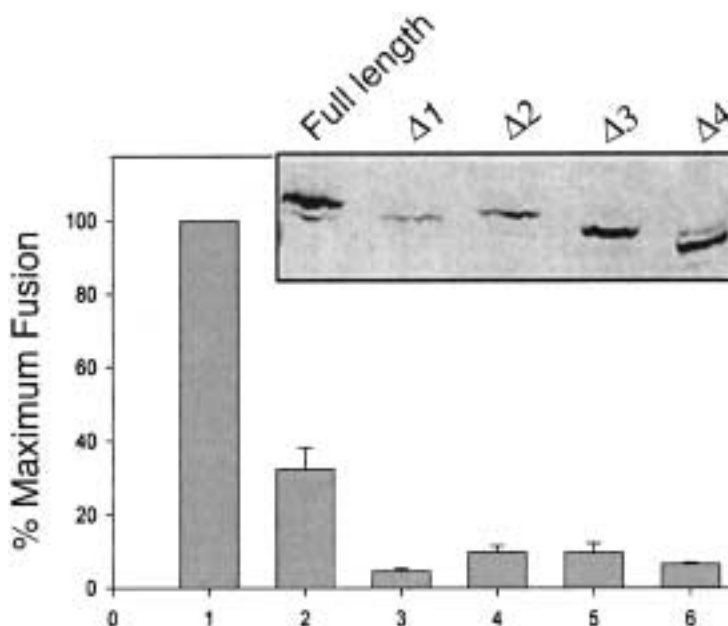

FIG. 7. RET fusion assay between  $R_{18}$ -labelled plasma membrane vesicles and various target membranes. The percent maximal fusion is shown for mixtures of  $R_{18}$ -labelled plasma membrane vesicles and  $F_{18}$ -labelled, disks (bar 1), or COS cell membranes from cells transfected with full-length FLAG-peripherin/rds (bar 2),  $\Delta 1$  mutant (bar 3),  $\Delta 2$  mutant (bar 4),  $\Delta 3$  mutant (bar 5) or  $\Delta 4$  mutant (bar 6). Inset, Western blot probed with anti-FLAG antibody showing the amount of expressed protein in each sample.

expression or localization in the COS cell system. However, the utility of COS cells is limited in that they are not polarized neuronal cells and certainly lack specific machinery required for transport/sorting. Our results therefore, do not preclude the possibility that the peripherin/rds C-terminus is important for directing localization of this protein in ROS. This question is currently being addressed using peripherin/rds-GFP fusion constructs to create transgenic *Xenopus laevis* (Lee et al., 2001; Tam et al., 2001). Initial results are conflicting however, with one group reporting that the C-terminus is required for proper targeting to ROS (Tam et al., 2001) and another reporting that the C-terminus is not required (Lee et al., 2001).

The C-terminal mutants also behave normally with respect to glycosylation and complex formation with rom-1. Interestingly, when the entire C-terminal domain was removed in the  $\Delta 4$  mutant, additional slower migrating bands were seen (Fig. 3). It is possible that the  $\Delta 4$  mutant is somewhat misfolded, thereby exposing a previously inaccessible glycosylation site, which resulted in the additional bands. Alternatively, conformational changes resulting from the loss of the entire C-terminus may have caused the changes in migration. In either case, all protein forms were reduced to a single non-glycosylated form in the presence of Endo-H. Native ROS peripherin/rds forms heterotetramers and higher order complexes with rom-1 (Goldberg and Molday, 1996; Loewen and Molday, 2000). Loewen and Molday (2000) have presented evidence suggesting that the sites of non-covalent interactions between peripherin/rds and rom-1 are within the D2 loop of peripherin/rds. Our results showing complex formation between rom-1 and each of the four mutated forms of peripherin/rds suggest that the C-terminus is most likely not the site of interaction between peripherin/rds and rom-1 and are consistent with previous results.

Prior work has identified a region within the C-terminus of peripherin/rds proposed to be the fusion domain of this protein (Boesze-Battaglia et al., 1997, 1998). This region corresponding to amino acids 311–325 is an amphiphilic  $\alpha$ -helix (Boesze-Battaglia et al., 1998), a secondary structure common to other fusion proteins (White, 1990). Deletion mutants within the C-terminus of peripherin/rds that either disrupt ( $\Delta 2$  mutant) or omit ( $\Delta 3$  and  $\Delta 4$  mutants) this fusion domain, do not promote membrane fusion. These observations provide strong support for our conclusions that the fusogenic region of peripherin/rds resides in the C-terminus and that the fusogenic domain within the C-terminus lies between amino acids 311–325. In addition, the  $\Delta 2$  mutant approximates the stop mutation that is associated with a retinal degenerative disease state described by Felbor et al. (1997). Similarly, Kohl et al. (1997) have described a retinal degenerative disease that is associated with a second stop mutation in peripherin/rds corresponding to the  $\Delta 4$  mutant. Our

findings represent the first biochemical abnormalities associated with these mutated forms of peripherin/rds found in either degenerative disease.

Interestingly, the truncation mutant ( $\Delta 1$ ) which lacks the last 20 amino acids of the C-terminus, but which retains an intact fusion domain (i.e., amino acids 311–325) did not promote fusion. This observation was not altogether unexpected since the anti-peripherin/rds monoclonal antibody 2B6, partially inhibits disk-plasma membrane and peripherin/rds LUV-plasma membrane fusion. The epitope for this monoclonal antibody resides within the terminal 30 amino acids of the protein (Connell and Molday, 1990). Most likely, the 20 amino acid region missing in the  $\Delta 1$  mutant is itself not a fusion domain because in vitro studies using a synthetic peptide mimicking this region did not by itself promote fusion between ROS plasma membrane vesicles and lipid vesicles (Boesze-Battaglia et al., 1997). Of note, Stefano et al. (2002) have recently generated a peripherin/rds mutant lacking the C-terminal 10 amino acids and expressed this protein in MDCK cells. This mutation does not disrupt the third  $\alpha$ -helical domain and is capable of mediating membrane fusion. Similar results were also seen in COS cells (Boesze-Battaglia, unpubl. res).

Our previous studies have suggested that the fusion competent form of the fusion peptide (a.k.a. PP-5) and by inference, peripherin/rds, requires the formation of a homotetrameric complex. It is unlikely, however, that the failure of the  $\Delta 1$  mutant to promote fusion can be ascribed to an inability of this mutant to form tetramers because evidence of homo-oligomer formation was detected with this mutant (Fig. 5). The finding that the  $\Delta 1$  mutant forms higher order complexes but is not fusion competent indicates that formation of a tetrameric state is not solely responsible for conferring fusion competency. It can also be concluded that domains within the C-terminus, other than the fusion domain (amino acids 311–322), are required for the formation of a fusion competent form of peripherin/rds. Thus, the region corresponding to the terminal 20 amino acids most likely aids in promoting the fusion competency of this protein. Such domains have been described for viral membrane fusion proteins and intracellular trafficking fusion proteins as contributing to the formation of hairpins (a.k.a., SNAREpins), necessary to form a fusion pore (Weber et al., 1998). How these regions interact and their structural identity remains to be determined.

### Acknowledgements

The authors thank Dr R. Molday for generously providing the anti-peripherin/rds monoclonal antibody, 2B6. We also thank Frank Stefano for valuable technical advice and assistance. This research was supported by grants from the National Institutes of Health (EY12266 to SMW and EY10420 to KBB) and from Fight for Sight, Inc., (GA97099 to SMW).

## References

- Arikawa, K., Molday, L. L., Molday, R. S. and Williams, D. S. (1992). Localization of peripherin/rds in the disk membranes of cone and rod photoreceptors: relationship to disk membrane morphogenesis and retinal degeneration. *J. Cell Biol.* **116**, 659–67.
- Ausubel, F. M. (1999). *Current Protocols in Molecular Biology*. John Wiley.
- Bartlett, G. R. (1959). Phosphorous assay in column chromatography. *J. Biol. Chem.* **234**, 3440–50.
- Bascom, R. A., Manara, S., Collins, L., Molday, R. S., Kalnins, V. I. and McInnes, R. R. (1992). Cloning of the cDNA for a novel photoreceptor membrane protein (rom-1) identifies a disk rim protein family implicated in human retinopathies. *Neuron* **8**, 1171–84.
- Boesze-Battaglia, K. and Albert, A. D. (1989). Fatty acid composition of bovine rod outer segment plasma membrane. *Exp. Eye Res.* **49**, 699–701.
- Boesze-Battaglia, K., Kong, F., Lamba, O. P., Stefano, F. P. and Williams, D. S. (1997). Purification and light-dependent phosphorylation of a candidate fusion protein, the photoreceptor cell peripherin/rds. *Biochemistry* **36**, 6835–46.
- Boesze-Battaglia, K., Lamba, O. P., Napoli, A. A., Jr., Sinha, S. and Guo, Y. (1998). Fusion between retinal rod outer segment membranes and model membranes: a role for photoreceptor peripherin/rds. *Biochemistry* **37**, 9477–87.
- Boesze-Battaglia, K., Stefano, F. P., Fenner, M. and Napoli, A. A. (2000). A peptide analogue to a fusion domain within photoreceptor peripherin/rds promotes membrane adhesion and depolarization. *Biochim. Biophys. Acta* **1463**, 343–54.
- Boesze-Battaglia, K. and Yeagle, P. L. (1992). Rod outer segment disc membranes are capable of fusion. *Invest. Ophthalmol. Vis. Sci.* **33**, 484–93.
- Caradonna, S. J., Ladner, R. D., Hansbury, M., Kosciuk, M., Lynch, F. and Muller, S. J. (1996). Affinity purification and comparative analysis of two distinct human uracil-DNA glycosylases. *Exp. Cell Res.* **222**, 345–59.
- Connell, G. J. and Molday, R. S. (1990). Molecular cloning, primary structure, and orientation of the vertebrate photoreceptor cell protein peripherin in the rod outer segment disk membrane. *Biochemistry* **29**, 4691–8.
- Felbor, U., Schilling, H. and Weber, B. H. (1997). Adult vitelliform macular dystrophy is frequently associated with mutations in the peripherin/RDS gene. *Hum. Mutat.* **10**, 301–9.
- Goldberg, A. F., Loewen, C. J. and Molday, R. S. (1998). Cysteine residues of photoreceptor peripherin/rds: role in subunit assembly and autosomal dominant retinitis pigmentosa. *Biochemistry* **37**, 680–5.
- Goldberg, A. F. and Molday, R. S. (1996). Subunit composition of the peripherin/rds-rom-1 disk rim complex from rod photoreceptors: hydrodynamic evidence for a tetrameric quaternary structure. *Biochemistry* **35**, 6144–9.
- Goldberg, A. F., Moritz, O. L. and Molday, R. S. (1995). Heterologous expression of photoreceptor peripherin/rds and Rom-1 in COS-1 cells: assembly, interactions, and localization of multisubunit complexes. *Biochemistry* **34**, 14213–9.
- Kedzierski, W., Bok, D. and Travis, G. H. (1999). Transgenic analysis of rds/peripherin N-glycosylation: effect on dimerization, interaction with rom1, and rescue of the rds null phenotype. *J. Neurochem.* **72**, 430–8.
- Kedzierski, W., Moghrabi, W. N., Allen, A. C., Jablonski-Stiemke, M. M., Azarian, S. M., Bok, D. and Travis, G. H. (1996). Three homologs of rds/peripherin in *Xenopus laevis* photoreceptors that exhibit covalent and non-covalent interactions. *J. Cell Sci.* **109**, 2551–60.
- Kohl, S., Christ-Adler, M., Apfelstedt-Sylla, E., Kellner, U., Eckstein, A., Zrenner, E. and Wissinger, B. (1997). RDS/peripherin gene mutations are frequent causes of central retinal dystrophies. *J. Med. Genet.* **34**, 620–6.
- Kohl, S., Giddings, I., Besch, D., Apfelstedt-Sylla, E., Zrenner, E. and Wissinger, B. (1998). The role of the peripherin/rds gene in retinal dystrophies. *Acta Anat.* **162**, 75–84.
- Laemmli, U. K. (1970). Cleavage of structural proteins during the assembly of the head of the bacteriophage T4. *Nature* **227**, 680.
- Lee, E. S., Burnside, B. and Flannery, J. G. (2001). Trafficking of C-terminal truncated peripherin/rds in transgenic *Xenopus laevis*. In *ARVO 2001 Annual Meeting*, Vol. 42. IOVS: Fort Lauderdale, FL, U.S.A.
- Litman, B. J. (1973). Lipid model membranes. Characterization of mixed phospholipid vesicles. *Biochemistry* **12**, 2545–54.
- Loewen, C. J. R. and Molday, R. S. (2000). Disulfide-mediated oligomerization of peripherin/rds and rom-1 in photoreceptor disk membranes. Implications for photoreceptor outer segment morphogenesis and degeneration. *J. Biol. Chem.* **275**, 5370–8.
- Matsumoto, B. and Besharse, J. C. (1995). Light and temperature modulated staining of the rod outer segment distal tips with lucifer yellow. *Invest. Ophthalmol. Vis. Sci.* **24**, 832–43.
- Moritz, O. L. and Molday, R. S. (1996). Molecular cloning, membrane topology, and localization of bovine rom-1 in rod and cone photoreceptor cells. *Invest. Ophthalmol. Vis. Sci.* **37**, 352–62.
- Muller-Weeks, S., Mastran, B. and Caradonna, S. (1998). The nuclear isoform of the highly conserved human uracil-DNA glycosylase is an Mr 36,000 phosphoprotein. *J. Biol. Chem.* **273**, 21909–17.
- Oprian, D. (1993). In: *Expression of Opsin Genes in COS cells*. Academic Press: San Diego, CA, U.S.A.
- Partearroyo, M. A., Cabezon, E., Nieva, J. L., Alonso, A. and Goni, F. M. (1994). Real-time measurements of chemically-induced membrane fusion in cell monolayers, using a resonance energy transfer method. *Biochim. Biophys. Acta* **1189**, 175–80.
- Poetsch, A. M., Molday, L. L. and Molday, R. S. (2001). The cGMP-gated channel and related glutamic acid rich proteins interact with peripherin-2 at the rim region of rod photoreceptor disc membranes. *J. Biol. Chem.* **273**, 48009–16.
- Sambrook, J., Fisher, S. K. and Anderson, D. H. (1989). In: *Molecular Cloning: A Laboratory Manual*. Cold Spring Harbor Laboratory: Cold Spring Harbor, NY, U.S.A.
- Sanyal, S. and Jansen, H. G. (1981). Absence of receptor outer segments in the retina of rds mutant mice. *Neurosci. Lett.* **21**, 23–6.
- Schagger, H. and von Jagow, G. (1987). Tricine-sodium dodecyl sulfate-polyacrylamide gel electrophoresis for the separation of proteins in the range from 1 to 100 kDa. *Anal. Biochem.* **166**, 368–79.
- Stefano, F. P., Krouse, J., Marta, P. and Boesze-Battaglia, K. (2002). Heterologous expression of WT and mutant photoreceptor peripherin/rds in Madin Darby Canine Kidney (MDCK) cells; an assessment of fusogenic function. *Exp. Eye Res.* **74**, 267–83.
- Steinberg, R. H., Fisher, S. K. and Anderson, D. H. (1980). Disc morphogenesis in vertebrate photoreceptors. *J. Comp. Neurol.* **190**, 501–8.
- Struck, D. K., Hoekstra, D. and Pagano, R. E. (1981). Use of resonance energy transfer to monitor membrane fusion. *Biochemistry* **20**, 4093–9.

- Tam, B. M., Moritz, O. L., Hurd, L. B. and Papermaster, D. S. (2001). Are the COOH terminal regions for rod outer segment proteins potential targeting signals? In: *ARVO 2001 Annual Meeting*, Vol. 42. IOVS: Fort Lauderdale, FL, U.S.A.
- Towbin, H., Staehelin, T. and Gordon, J. (1979). Electrophoretic transfer of proteins from polyacrylamide gels to nitrocellulose sheets: procedure and some applications. *Proc. Nat. Acad. Sci. U.S.A.* **76**, 4350–4.
- Travis, G. H., Brennan, M. B., Danielson, P. E., Kozak, C. A. and Sutcliffe, J. G. (1989). Identification of a photoreceptor-specific mRNA encoded by the gene responsible for retinal degeneration slow (rds). *Nature* **338**, 70–3.
- Travis, G. H., Sutcliffe, J. G. and Bok, D. (1991). The retinal degeneration slow (rds) gene product is a photoreceptor disc membrane-associated glycoprotein. *Neuron* **6**, 61–70.
- van Nie, R., Ivanyi, D. and Demant, P. (1978). A new H-2-linked mutation, rds, causing retinal degeneration in the mouse. *Tissue Antigens* **12**, 106–8.
- Weber, T., Zemelman, B. V., McNew, J. A., Westermann, B., Gmachl, M., Parlati, F., Sullner, T. and Rothman, J. E. (1998). SNAREpins: minimal machinery for membrane fusion. *Cell* **92**, 759–72.
- White, J. M. (1990). Viral and cellular membrane fusion proteins. *Annu. Rev. Physiol.* **52**, 675–97.
- Wrigley, J. D. J., Ahmed, T., Nevett, C. L. and Findlay, J. B. (2000). Peripherin/rds influences membrane vesicle morphology: implications for retinopathies. *J. Biol. Chem.* **275**, 13191–4.