

(IMPLICIT) ARGUMENT INTRODUCTION, VOICE AND CAUSATIVES

Faruk Akkuş

A DISSERTATION

in

Linguistics

Presented to the Faculties of the University of Pennsylvania

in

Partial Fulfillment of the Requirements for the

Degree of Doctor of Philosophy

2021

Supervisor of Dissertation

Julie Anne Legate, Professor of Linguistics

Graduate Group Chairperson

Eugene Buckley, Associate Professor of Linguistics

Dissertation Committee:

David Embick, Professor of Linguistics

Florian Schwarz, Associate Professor of Linguistics

(IMPLICIT) ARGUMENT INTRODUCTION, VOICE AND CAUSATIVES

COPYRIGHT

2021

Faruk Akkuş

ACKNOWLEDGMENT

This dissertation would not have been possible without the help of countless people who helped provide me with support and direction throughout this challenging process. In particular, a big thanks to my dissertation committee: Julie Anne Legate, David Embick and Florian Schwarz.

Julie’s creativity and analytical rigor always challenged me to reconsider even my most cherished ideas. She made sure that I considered all potential alternatives before getting too invested in one idea. Even then she encouraged me to remain willing to update my hypotheses in light of new evidence—even if that meant challenging my previous work. I only hope I can continue to challenge myself to the same degree without her there to do the questioning.

Julie’s multiple rounds of detailed feedback helped me build a manuscript from the ground up: she helped me distill my disparate thoughts into streamlined arguments and stuck with me through the final stages of polishing and refining the work. Her constant words of encouragement helped keep me going at times (which were very often!) when I felt hopeless and stuck. I only hope I can do half as good a job as she does at mentoring and advising, and will always be honored to call her my mentor.

Even though Dave wasn’t my official advisor, he went above and beyond to mentor me throughout my time at Penn. I had many great and inspiring conversations with Dave. He has a way of connecting seemingly unrelated ideas into a broader perspective thus helping me contextualize my work and make my isolated pockets of research engage with the broader literature. Brainstorming sessions with Dave often left me with more questions than answers but those questions have always pointed me in the right direction, enlarging the scope of my work. I also appreciated Dave allowing me to enjoy his wonderful tea collection during our meetings.

Meetings and conversations with Florian Schwarz brought to life many of the semantic ideas and specific implementations utilized in my dissertation. Thank you to Florian for spearheading my semantic training and showing me how interconnected syntax and seman-

tics are. I only wish I were a better semantics student to better do justice to semantics in my work. I guess this means I will keep bothering him to fix my lambdas.

Martin Salzmann came along towards the end of my time at Penn but even in this limited time I have learned so much from him. Some of the ideas that made it into the dissertation either directly came from Martin or were inspired by our conversations. He also gave me valuable advice in my job search process.

Penn faculty were always ready and enthusiastic to meet with students on even short notice. TAing for Beatrice Santorini taught me a lot both in terms of teaching and looking at some syntactic phenomena from a different angle. My work in Alison Biggs' classes set me on the path pursuing some of the topics in the dissertation and her feedback was instrumental in developing these ideas. My conversations with Don Ringe, Tony Kroch, Charles Yang outside of class were very stimulating and brought to my attention angles I had not considered.

My time at Yale put me on the long path toward this dissertation. I want to thank all of my Yale professors Bob Frank, Jim Wood, Raffaella Zanuttini, Ashwini Deo, Claire Bower, Steve Anderson and Larry Horn. Also many thanks to my fellow linguistics graduate students and colleagues: Josh Phillips, Martin Fuchs, Chris Geissler, Parker Brody, Manu Quadros, Matt Tyler, Rikker Dockum, Kevin Tang and Jason Zentz as well as many others who are not mentioned here. I am very appreciative of their support during my transition period to Penn.

Of course none of my PhD work would have been possible without the foundation I built during my time at Boğaziçi University. I thank all of my professors and colleagues there, particularly my MA advisor Balkız Öztürk, Sumru Özsoy, Aslı Göksel, Mine Nakipoğlu as well as my linguistics friends Büşra, Seda, Songül, Deniz, Ömer, Nil, and many others.

Although there are too many to list all of them here, I am grateful to my Turkish and Sason Arabic consultants. They suffered through many hours of judgments (directly or by proxy) and deserve a lot of credit. There were many occasions in which speakers vehemently disagreed with one another, showing me once again the level of variation that can

exist, sometimes even in a very small region. Special thanks to Ali Akkuş, Delal Akkuş, Şefik Akkuş, Turan Akkuş, Sabri Yağmur, Zemire Yağmur, Murat Yıldırım, Uğurcan Vurgun, Hakimo Baran, Hikmet Dağlıyan, Songül Gündoğdu, Dursun Altınok, Deniz Özyıldız, Duygu Göksu, Mehmet Köse, Kemal Aksu, Betül Erbaşı, Kemal Gürler, Emre Hakgüder, Ahmet Bilal Özdemir, Yılmaz Köylü, Murat Yolun, Bilge Palaz.

I have had the opportunity to present several parts of the dissertation in various conferences, workshops and invited lectures, some of which are: WCCFL37, TU+6, LSA 2020, NELS 48, NELS 50, TripleA 6, CLS 55, GLOW 42, ASAL 33, Passives - A Cross-linguistic Workshop (University of Vienna), Cambridge Workshop on Voice (CamVoice). These occasions allowed me to meet with many great researchers, some of whose names I am bound to forget to mention here. They provided me with incredibly helpful comments and ideas which made their way into the dissertation and other studies. Thanks to Elabbas Benmamoun, David Pesetsky, Gary Thoms, Benjamin Bruening, Kyle Johnson, Susi Wurmbrand, Hamid Ouali, Peter Hallman, Dalina Kallulli, Rajesh Bhatt, Gregory Key, Jessica Coon, Stefan Keine, Roumyana Pancheva, Jonathan Bobaljik, Doreen Georgi, Andreas Blümel, Rafael Abramovitz, Yining Nie, Donka Farkas, Jianrong Yu and William Johnston. During my time at Penn I was able to discuss parts of the dissertation with visiting scholars and invited speakers from other linguistics departments. Thank you to: Kyle Johnson, Jim Wood, Hadas Kotek, Mitcho Erlewine, Emily Clem.

Similarly, some parts of the dissertation have been or will soon be published in several journals, such as *Language*, *Journal of Linguistics*, *Linguistic Inquiry*, and *Syntax* as well as proceedings such as NELS and WCCFL. Thank you to the editors and many anonymous reviewers of these journals whose insightful criticisms, and constructive feedback not only improved the quality of the articles, but also this dissertation.

Fellow linguists at Penn have made this arduous process more fun and enjoyable both intellectually and socially. Thank you to my cohort: Ryan Budnick, Yosiane White, Nikita Bezrukov, Ruaridh Purse and Nari Rhee. Moreover, thanks to Uğurcan Vurgun, Luke Adamson, Milena Šereikaitė, Spencer Caplan, Jordan Kodner, Akiva Bacovcin, Hassan Munshi,

Ava Creemers, Ava Irani, Andrea Ceolin, Lefteris Pappas, Nattanun (Pleng) Chanchaochai, Johanna Benz, Rob Wilder, Kajsa Djärv, Einar Freyr Sigurðsson, Alexandros Kalomoiros, Helen Jeoung, Wei Lai, Anton Karl Ingason, Aaron Freeman, Hong Zhang and Ollie Sayeed. Special thanks to Amy Forsyth for answering all my administrative questions and concerns.

Thanks to my family, who have had to sacrifice so much for me to be able to continue my studies. Finally, thanks to my partner Emily who has been incredibly supportive and has stuck with me all this time.

ABSTRACT
(IMPLICIT) ARGUMENT INTRODUCTION, VOICE AND CAUSATIVES

Faruk Akkuş
Julie Anne Legate

This dissertation explores the syntactic and semantic properties of implicit arguments in various voice constructions, such as active and passive voice, applicatives, causatives and impersonals, using mainly Sason Arabic (SA) and Turkish as empirical starting points.

I add to the typology of null arguments, further demonstrating that they do not form a homogeneous category (e.g. Williams 1985; Rizzi 1986; Bhatt and Pancheva 2017; Landau 2010). My investigation reveals (at least) four types of implicit arguments in languages under investigation in terms of their semantic properties and syntactic visibility: (i) an existentially closed passive agent, (ii) a full DP, (iii) a free variable, and (iv) an impersonal pronoun.

Establishing a distinction in Turkish between two constructions with identical morphology, i.e., passive and impersonal, I show that the implicit agent of passive is unprojected, whereas the null impersonal pronoun is fully projected. I also demonstrate that purported ‘passives of passives’ in Turkish are in fact impersonals of passives, and passives cannot iterate. This follows from an analysis of passive as a subtype of Voice, the head that introduces the external θ -role (following Legate 2014). I compare the null impersonal with the overt impersonal *insan* ‘human’ in Turkish, indicating that they exhibit distinct behavior. I also provide a syntactic analysis of the passive that confirms and captures the generalization that passive cannot iterate (Perlmutter and Postal 1977).

The approach to passive adopted in the dissertation predicts that an active-passive-like alternation should be available to other functional categories, such as ApplP or CauseeP. Accordingly, I investigate several morphological and periphrastic causative constructions from SA and Turkish, arguing that this prediction is borne out. While all the causatives embed a second VoiceP, the behavior of this VoiceP varies across causative constructions: some are like the canonical, agentive VoiceP, whereas the behavior of others warrants identifying them as distinct categories, specifically Voice_{CAUSEE}P or CauseeP.

Furthermore, the investigation of ‘make’ causatives in SA reveals that the embedded agent may be present (i) as a free variable on thematic, active Voice head (*à la* Heim 1982) without needing a specifier or (ii) as a full DP, which is separated from its licensor by a phase domain and needs to \bar{A} -move to be (Case)-licensed.

Table of Contents

Acknowledgment	iii
Abstract	vii
List of Tables	x
1 Introduction	1
2 Impersonals versus Passives	6
2.1 Passives of Passives	7
2.1.1 Turkish Passives	9
2.1.2 Turkish Impersonals	15
2.1.3 Status of the Initiator in Turkish Passives vs Impersonals	17
2.1.4 Passive of a Passive?	34
2.1.5 Analysis of Impersonal	37
2.1.6 Analysis of Passive	46
2.2 Impersonals in Negation-Licensed Commands	58
2.3 Overt impersonal in Turkish	65
2.3.1 Properties of the overt impersonal	65
2.3.2 Towards an account	84
2.4 Chapter summary	88
3 Causatives in Sason Arabic	89
3.1 Types of causatives in Sason Arabic	90
3.2 ‘make’ causatives in Sason Arabic	95
3.2.1 Size of the embedded structure	101
3.2.2 An embedded VoiceP with active-passive alternation	118
3.2.3 Theme as the grammatical object	128
3.2.4 Embedded agent as a free variable	131
3.2.5 Locality and Licensing	152
3.3 Geminate and ‘give’-causatives in Sason Arabic	174
3.3.1 Active-passive alternation	178

3.3.2	The causee is not in VoiceP	190
3.3.3	Proposal: CauseeP and bundling with ApplP	195
3.3.4	Co-occurrence with an applied argument	199
3.4	Chapter summary	211
4	Causatives in Turkish	213
4.1	A first look at causatives in Turkish	214
4.2	Size of the embedded structure	217
4.2.1	An overview of some previous literature	217
4.2.2	The structure of the embedded constituent	225
4.3	The status of the overt (dative) causee	233
4.3.1	Clefting	234
4.3.2	Passivization in non-standard Turkish	236
4.3.3	Long-distance scrambling	244
4.3.4	Island Constraints	246
4.3.5	The overall structure of Turkish causatives	247
4.4	The interpretation of the null causee	251
4.4.1	Nonpassivizable idioms	252
4.4.2	Sluicing	254
4.4.3	Anaphoric and pronominal binding	256
4.4.4	Depictive licensing	264
4.4.5	The structures for overt and null causee	265
4.5	Existential interpretation and transitivity	268
4.5.1	Case of the Causee	271
4.5.2	Existential interpretation for Causee	276
4.6	Chapter summary	281
5	Conclusion	282
	Bibliography	286

List of Tables

2.1	Passives vs impersonals in Turkish	33
2.2	Properties of impersonal pronouns (v1)	66
2.3	Verbal agreement and reciprocal in Turkish	69
2.4	Impersonals in Turkish	74
2.5	Properties of impersonal pronouns (v2)	76
2.6	Generalizations of imp- ϕ vs imp-N	78
2.7	Properties of impersonal pronouns (final)	84
2.8	Patterns of impersonals	85
3.1	Size of ‘make’-causatives complement (v1)	102
3.2	Size of ‘make’-causatives complement (final)	116
3.3	Active-passive embedded VoiceP	128
3.4	Binding properties in Voice types	138
3.5	Properties of causative types	208
4.1	Passive typology	268
4.2	Passivization paradigm	270
4.3	Causativization paradigm	270
4.4	Existential interpretation paradigm	271
4.5	Predicate types and interpretation of Causee	280

Chapter 1

Introduction

In this dissertation, I explore the relationship between Voice, (implicit) argument introduction and licensing, using mainly Sason Arabic (SA, a Semitic language) and Turkish (a Turkic language) as empirical starting points. These languages provide good testing grounds for the topics in question that have long been the subject of exploration in the literature. Within recent years, research on Voice (e.g., passive vs. active) projection has increased significantly. Specifically, it has been proposed that VoiceP is a functional projection that is distinct and separate from vP: VoiceP introduces the external θ -role, whereas vP may introduce causative semantics (Pylkkänen 2002, 2008; Schäfer 2008; Harley 2013; Legate 2014, i.a.). This study builds on these claims and aims to provide a better understanding of the syntax of different types of Voice constructions, and their impacts on argument introduction and licensing, as well as phase theory. To address this avenue of research, I test data that consists of different types of Voice related phenomena in SA and Turkish, including passives, causatives and applicatives.

The dissertation contributes to the discussion and ontology of ‘implicit arguments’, addressing several questions such as whether implicit arguments form a homogeneous category or the extent to which they are visible to syntax (cf. Bhatt and Pancheva 2006, 2017; Landau 2010). The investigation demonstrates that a single language can have multiple types of implicit arguments, and reveals (at least) four types of implicit arguments in the languages in question: (i) an existentially closed passive agent, (ii) a full DP, subject to locality constraints for licensing, (iii) a free variable, and (iv) an impersonal pronoun.

In Chapter 2, I investigate the properties of null and overt impersonals in Turkish,

focusing on ‘passives of passives’ in Turkish, the so-called Negation-Licensed Commands (cf. Iatridou accepted) in Turkish (along with Sason Arabic and English), and the dedicated overt impersonal *insan* ‘human’ in Turkish.

The investigation of ‘passives of passives’ in Turkish reveals that they are in fact ‘impersonals of passives’. I demonstrate the existence of two distinct constructions with identical morphology: (i) a *passive*, which is limited in application to transitive predicates with a thematic subject and structurally case marked object, and (ii) an *impersonal*, in which there is no argument demotion – an unpronounced impersonal pronoun fills the argument position, be it the thematic subject or the thematic object. This finding provides support to the original claim by Perlmutter and Postal (1977, et seq) that passive verbs cannot undergo passivization. Following Legate 2014, I analyze passive as a variant of the Voice head that introduces a DP in its specifier. On the other hand, in the impersonal construction, the functional head Impers⁰ licenses the impersonal pronoun, implemented via the Agree operation.

The chapter further argues that the null impersonal is also found in Negation-Licensed Commands (NLCs), nominalizations that become commands in the presence of negation, despite crosslinguistic variation in the morphosyntactic expressions of them. NLCs are characterized by the use of a gerund in combination with a special negative marker in English, as illustrated in (1).

- (1) a. No playing soccer inside the house!
- b. No throwing trash off the window!

Focusing on NLCs from Turkish, SA and English, I argue that in NLCs as well, an unpronounced impersonal pronoun in the form of PROARB can fill the argument position, (*pace* Pak et al. 2020, who suggest that NLCs do not syntactically project the subject).

The last part of the chapter investigates the behavior of the overt impersonal *insan* ‘human’ in Turkish in terms of its syntactic positions, cases it can bear, and interpretational restrictions it exhibits. Recent syntactic analyses (Egerland 2003, Fenger 2018, Ackema and Neeleman 2018, i.a.) classify impersonals into two types, one with more functional

structure including English *one*, Frisian *men*, and Icelandic *maður*; and one with less, including German, Norwegian, and Danish, *man*. Within this bifurcation, the Turkish impersonal marked with the ‘passive’ morpheme patterns with the latter type that contains less functional structure. Turkish also exhibits a second impersonal pronoun, *insan* ‘human’, which I argue is not just a pronounced counterpart of the null impersonal, but patterns with the former type, with more functional structure.

In Chapter 3, I investigate various causative constructions in Sason Arabic. In addition to allowing ‘make’ to embed a finite clause with causative interpretation, some speakers/sub-varieties of SA have a type of indirect causative embedded under the verb ‘make’, in which there is no overt embedded agent despite an agentive reading where the embedded agent is interpreted as indefinite ‘someone’ or ‘some people’, (2a). The embedded agent can be expressed in a ‘by’-phrase, (2b), but cannot be pronounced in-situ, (2c). Notably, it can be overtly realized when it undergoes \bar{A} -movement, as in (2d).

- (2) a. dāde sa-tte nazf haydan
 mom made-3F clean.INF wall
 ‘Mom made (someone) clean the wall.’
- b. dāde sa-tte nazf haydan mi nes-ma tawwil.
 mom made-3F clean.INF wall by person-a tall
 ‘Mom had the wall cleaned by someone tall.’
- c. *dāde sa-tte nes-ma tawwil / nes-ma nazf haydan.
 mom made-3F person-a tall / person-a clean wall
 ‘Mom had someone tall / someone wash the wall.’
- d. sima-tu mi nes-ma tawwil le dāde sa-tte nazf haydan.
 heard-1SG by person-a tall that mom made-3F clean wall
 ‘I’ve heard about some tall person that mom made clean the wall.’

I argue that the ‘make’-causatives embed a reduced structure: no AspP or higher projections (i.e. a restructuring configuration). I demonstrate that ‘make’-causatives in Sason Arabic can embed three structures: it embeds a passive VoiceP with an obligatory ‘by’-phrase, or an FP dominating an active VoiceP.

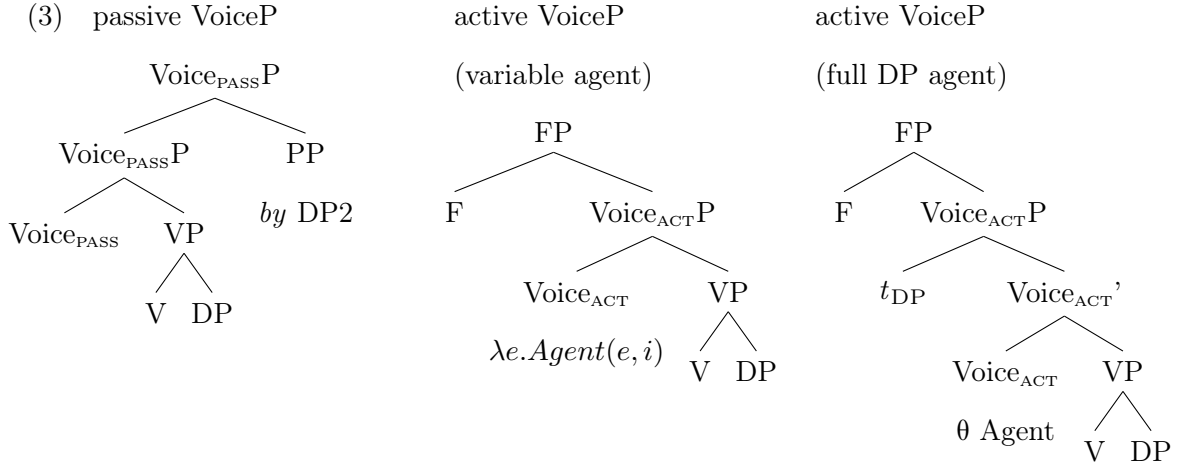

The embedded agent can be introduced in two ways in the active VoiceP: (i) as a ‘free variable’ on the Voice head. This adds to the typology of implicit arguments. It also shows that the object can be (Case-) licensed as an object independently of the thematic subject. (ii) as a full DP, which is subject to locality restrictions. The embedded agent needs to \bar{A} -move to be in local configuration with its licenser. As such, ‘make’-causatives are part of a larger crosslinguistic pattern, in which certain positions cannot be occupied by overt elements.

The chapter also discusses the other two indirect causative constructions: causatives formed with gemination and causatives embedded under the verb ‘give’. I argue that these causatives provide independent support to the analysis of passive in this dissertation (which follows Legate 2014), which treats passive as a variant of a functional head that introduces a DP in its specifier. One prediction of this analysis is that passive should be available to other functional heads such as applicative, and an active-passive-like alternation should be available to that functional head. I demonstrate that these two causative strategies do embed a second VoiceP; however this VoiceP exhibits distinct behavior from the canonical, agentive VoiceP, which warrants identifying it as a distinct category. As such, the causee in both constructions is generated in CauseeP. Furthermore, a variety of diagnostics show that geminates manifest an active-passive alternation, whereas the ‘give’ causatives embed only a passive CauseeP. Therefore, the null argument in these constructions is an implicit

‘agent’ of passives.

In Chapter 4, I investigate the properties of the causatives in Turkish from several different perspectives. In the first part of the chapter, I analyze the syntax of Turkish causatives, with a focus on determining the structural properties of the embedded constituent and the status of the overt causee versus null causee. Recently it has been argued that the overt causee in Turkish causatives is an adjunct, and not an argument (Key 2013; Harley 2017a; Nie 2020). I argue that this characterization is not warranted and that the overt causee is indeed an argument, base-generated in $\text{Spec, Voice}_{\text{CAUSEE}}\text{P}$. One of the arguments to that end involves investigation of some non-standard varieties of Turkish, which differ from the standard variety in the type of argument allowed to raise to the grammatical subject. On the other hand, the null causee is not syntactically projected, but is existentially interpreted in passive $\text{Voice}_{\text{CAUSEE}}\text{P}$.

The second part of the chapter addresses the question of which predicates allow the causee to be left unpronounced, and thus interpreted existentially. Stromdahl and Nematova 2019a,b argue that in Uzbek and Turkish, this hinges on the possibility of personal passivization, as such if a predicate can undergo passivization, then the relevant Causee can receive existential interpretation. Once we take into consideration a larger list of predicates, it turns out the possibility of existential interpretation is not connected to passivization or the Case of the Causee per se, but to transitivity. Only configurations that count as ‘transitive’ allow the Causee to be demoted and interpreted existentially. Crucially, the domain of transitivity in causatives is distinct from that of root clauses.

Chapter 5 summarizes the main points of the dissertation and concludes.

Chapter 2

Impersonals versus Passives

In this chapter I investigate the properties of null and overt impersonals in Turkish. In order to do so, I carefully examine various constructions, including ‘passives of passives’ in Turkish, the so-called Negation-Licensed Commands (cf. Iatridou accepted) in Turkish (along with Sason Arabic and English), and the overt impersonal *insan* ‘human’ in Turkish.

The investigation of purported passives of passives in Turkish reveals that they are in fact impersonals of passives. This finding provides support to the original claim by Perlmutter and Postal (1977, et seq) that passive verbs cannot undergo passivization. I also demonstrate the existence of two distinct constructions with identical morphology: (i) passive, and (ii) an impersonal, in which there is no argument demotion – an unpronounced impersonal pronoun fills the argument position. The chapter further argues that the null impersonal is also found in Negation-Licensed Commands, which are essentially nominalizations that become commands in the presence of negation.

The last part of the chapter investigates the behavior of the overt impersonal in Turkish, and shows that it is not just a pronounced counterpart of the null impersonal, but rather has a different status, with more functional structure in terms of the classification drawn in recent syntactic analyses (Egerland 2003, Fenger 2018, Ackema and Neeleman 2018, i.a.). I also note that the null impersonal in Turkish does not neatly fit into these classifications.

2.1 Passives of Passives

In this part of the chapter, I establish a restriction against iteration of the passive, focusing on the so-called ‘passives of passives’ in Turkish.¹ The issue came to the attention of linguists with the work of David Perlmutter and Paul Postal in the 1970s and 1980s (Perlmutter and Postal 1977, Perlmutter 1982, Perlmutter and Postal 1984, Postal 1986), in which it is argued that passive verbs cannot undergo passivization. In the intervening decades, three languages have surfaced as *prima facie* counterexamples – Turkish (Turkic: Turkey), Lithuanian (Baltic: Lithuania), and Classical Sanskrit (Indo-Aryan) (see i.a. Ostler 1979, Timberlake 1982, Keenan and Timberlake 1985, Özkaragöz 1986, Baker et al. 1989, Nakipoğlu-Demiralp 2001, Öztürk 2005, Özsoy 2009).² Indeed, recent theoretical work in three distinct frameworks (Bruening 2013, Kiparsky 2013, Murphy 2014) have taken these three languages as evidence for the theoretical approach required of the analysis of the passive. Specifically, they propose that the mechanism that, in descriptive terms, demotes the thematic subject must be quite general, able to also demote the thematic objects of passives. The *prima facie* passive of a passive in Turkish is exemplified in (4); note in particular the sequence of two passive morphemes (identical modulo the application of regular phonological processes, see Kornfilt 1997), and the apparent demotion of both the thematic subject and the thematic object.

- (4) a. Bu oda-da döv-ül-ün-ür.
this room-LOC beat-PASS-PASS-AOR
‘One is beaten (by one) in this room.’
- b. Harp-te vur-ul-un-ur.
war-LOC shoot-PASS-PASS-AOR
‘One is shot (by one) in the war.’ (Özkaragöz 1986, 77)

I re-examine the Turkish case and demonstrate that rather than counterexemplifying

¹This part of the chapter is a close version of Legate et al. 2020, which appeared in *Language* as well as Legate and Akkuş 2017.

²Irish was also mentioned in early work, e.g. Nerbonne 1982, but is now understood to involve an impersonal of a passive; see McCloskey 2007, Maling 2010, Legate 2014, *inter alia*.

Perlmutter and Postal’s generalization, it in fact confirms it.³ I demonstrate that the thematic object is not demoted, but rather is syntactically projected into argument position. I first carefully establish a distinction in Turkish between two constructions with identical morphology: (i) a passive, which is limited in application to transitive predicates with a thematic subject and structurally case marked object, and (ii) an impersonal, in which there is no argument demotion – an unpronounced impersonal pronoun fills the argument position, be it the thematic subject or the thematic object (see e.g. Blevins 2003 for discussion of the passive versus impersonal distinction). This provides further evidence against analyses of the passive involving syntactic projection of the initiator, e.g. Collins 2005. I then demonstrate that purported passives of passives in Turkish are in fact impersonals of passives.

The import of this case study, then, is the confirmation that the passive cannot iterate – it cannot apply to predicates that have already been passivized. In section 2.1.6, I discuss the consequences for the analysis of the passive. I argue that the generalization is naturally explained by a syntactic analysis that capitalizes on the intrinsic ordering imposed by the syntactic structure, whereby the object is composed with the verb before Voice⁰ is inserted (e.g. Bruening 2013, Legate 2014, Alexiadou et al. 2015), but not by analyses that posit passivization as a lexical or syntactic rule (Bresnan 2001, Blevins 2003, Culicover and Jackendoff 2005, Kiparsky 2013, Murphy 2014, i.a.). I develop a syntactic analysis of the passive that accounts for the findings. To preview, I argue that the passive has two semantic denotations (cf. Bruening 2013).

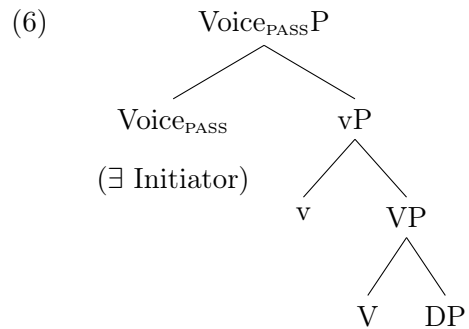
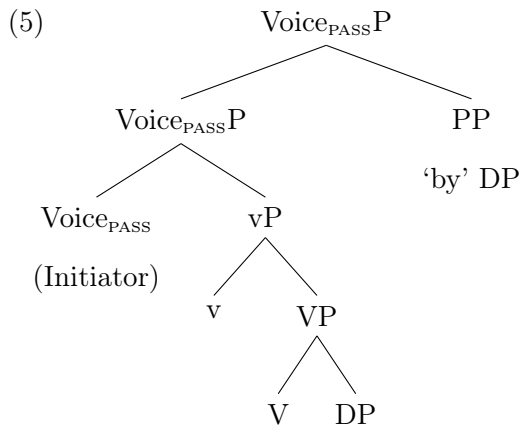

³The Lithuanian construction is an evidential of a passive, and the Sanskrit involves no passivization at all. See Legate et al. 2020 for the discussion.

It can allow the external θ -role to be satisfied by the ‘by’-phrase, when present, and otherwise be interpreted existentially. On the other hand, the impersonal can be introduced as an argument.

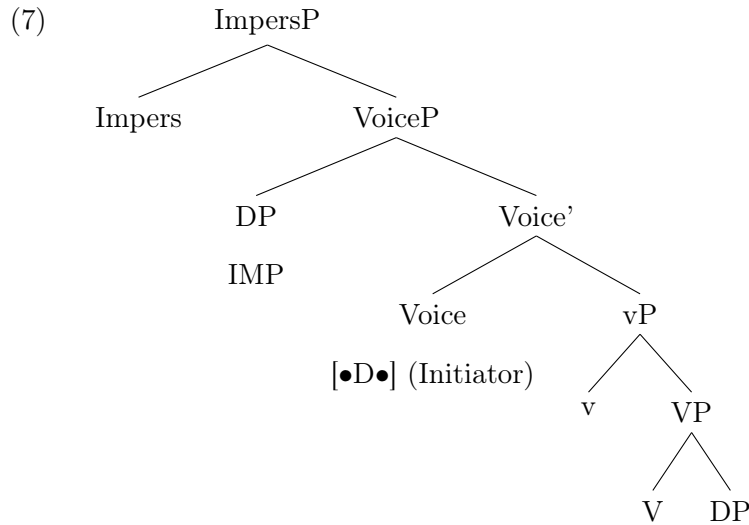

Before tackling the passive of passive, let us take a step back and examine the properties of constructions with a single passive morpheme. I argue that these bifurcate into a passive and an impersonal, each exhibiting a distinct set of characteristic behaviors.

2.1.1 Turkish Passives

The passive in Turkish is characterized by both the demotion of the thematic subject and by the promotion of an accusative thematic object to a nominative grammatical subject. (Nominative is null in the language, and I leave it unglossed.) The thematic subject may be expressed in a ‘by’-phrase headed by *tarafından*.⁴

- (8) a. Ali kitab-ı hızlı oku-du.
 Ali book-ACC quick read-PST
 ‘Ali read the book quickly.’

⁴This is morphologically decomposable, as follows.

(i) taraf -1 -ndan
 side -3SG -ABL

- b. Kitap (Ali tarafından) hızlı oku-n-du.
 book Ali by quick read-PASS-PST
 ‘The book was read (by Ali) quickly.’

Verbs without an accusative thematic object in the active do not allow the passive;⁵ this includes verbs with an object that is pseudo-incorporated or marked with an oblique case. (9b) illustrates pseudo-incorporation (cf 8b above), with the positioning of the unmarked object below the low manner adverb and the lack of accusative case on the object used as a diagnostics; see Massam 2001 on pseudo-incorporation and Kornfilt 2003 and Öztürk 2005 on the Turkish instance and these diagnostics. (10b) illustrates the oblique object subcase using the verb ‘kick’, which takes a dative object. (10c) illustrates that in certain varieties of Turkish, passivization of ‘kick’ is possible, with the dative patterning as structural in promoting to a nominative grammatical subject.

- (9) a. Ali hızlı kitap oku-du.
 Ali quick book read-PST
 ‘Ali did book-reading quickly.’
- b. *Ali tarafından hızlı kitap oku-n-du.
 Ali by quick book read-PASS-PST
 ‘Book-reading was done quickly by Ali.’⁶
- (10) a. Çocuk top-a vur-du.
 child ball-DAT kick-PST
 ‘The child kicked the ball.’
- b. *Top-a çocuk tarafından vur-ul-du.
 ball-DAT child by kick-PASS-PST
 ‘The ball was kicked by the child.’

⁵ I have encountered two native speakers of Turkish with a more permissive grammar than our ten primary consultants; for these speakers, verbs with oblique or pseudo-incorporated objects may undergo passivization, unergatives may marginally do so, and unaccusatives cannot. I return to the grammar of these speakers when it provides insights into the phenomenon under discussion. My observation is that Turkish is undergoing a change where passivization is becoming more flexible. More broadly, variation within Turkish is understudied. I focus on the variety spoken by the primary consultants, which they consider to be standard, but I mention any variation I am aware of.

⁶See also Öztürk 2005 for some discussion about non-passivization of verbs with pseudo-incorporated objects in Turkish.

- c. % Top çocuk tarafından vur-ul-du.
 ball child by kick-PASS-PST
 ‘The ball was kicked by the child.’

The pattern in (10c) has already been reported by Knecht (1986), who notes that for some speakers a clause containing an oblique transitive verb, e.g. the verb ‘worship’ in (11) which takes dative object, may also undergo canonical (‘personal’, in her terms) passivization; as such becomes the grammatical subject, as shown in (11c).

- (11) a. Ben san-a / *sen-i tap-tı-m.
 I you-DAT / *you-ACC worship-PST-1SG
 ‘I worshipped you.’
- b. San-a tap-ıl-dı.
 you-DAT worship-PASS-PST
 ‘There was worshipping to you.’
- c. % Sen tap-ıl-dı-n.
 you.NOM worship-PASS-PST-2SG
 ‘You were worshipped.’ (Knecht 1986:111)⁷

Regarding dative objects, it is notable that these behave as inert (in the sense of McGinnis 2001) in the presence of an accusative object. Thus, the accusative object of the active is promoted to the nominative grammatical subject, the dative neither itself moving, nor blocking movement past it. (See Tonyalı 2015 for further discussion of non-structural datives in Turkish.)

- (12) a. Adam bana şemsiye-yi tut-tu.
 man me.DAT umbrella-ACC hold-PST
 ‘The man held the umbrella for me.’
- b. Şemsiye adam tarafından bana tut-ul-du.
 umbrella man by me.DAT hold-PASS-PST
 ‘The umbrella was held for me by the man.’
- c. *Bana adam tarafından şemsiye-yi tut-ul-du-(m).
 me.DAT man by umbrella-ACC hold-PASS-PST-(1SG)
 ‘I was held the umbrella by the man.’

⁷I added the % symbol to indicate that it is grammatical only for certain varieties of Turkish.

Interestingly, we find that in non-standard varieties of Turkish, the dative behaves as structural rather than inert (see Chapter 4 for more discussion of these varieties). In these varieties, passivization of verbs with a dative object is grammatical, and therefore the dative object of the active raises to the nominative grammatical subject of the passive.⁸

- (13) a. Komşu-lar adam-lar-a yardım et-ti-ler.
 neighbour-PL man-PL-DAT help do-PST-PL
 ‘The neighbours helped the men.’
- b. *Adam-lar-a komşu-lar tarafından yardım ed-il-di-(ler).
 man-PL-DAT neighbour-PL by help do-PASS-PST-PL
 ‘The men were helped by the neighbours.’
- c. % Adam-lar komşu-lar tarafından yardım ed-il-di-ler.
 man-PL neighbour-PL by help do-PASS-PST-PL
 ‘The men were helped (by the neighbours).’

Turkish allows reflexive and reciprocal predicate formation with a few different verbal roots (e.g. Kornfilt (1997, 139); Göksel and Kerslake (2005, 73-74)). This limited number of predicates formed with the addition of the reflexive suffix *-(I)n* and the reciprocal suffix *-(I)ş* also cannot be passivized, as illustrated in (14) and (15), respectively.⁹

- (14) a. Çocuk-lar bu dere-de yıka-n-ır-lar.
 child-PL this river-LOC wash-REFL-AOR-PL
 ‘The children have a bath in this river.’
- b. *Bu dere-de çocuk-lar tarafından yıka-n-ıl-ır.
 this river-LOC child-PL by wash-REFL-PASS-AOR
 ‘It is washed by the children in this river.’
- (15) a. İki-si eski-den hep yüz yüze gör-üş-ür-ler-di.
 the.two old-ABL always in person see-RECP-AOR-PL-PST
 ‘The two used to meet in person all the time in the past.’

⁸Note that ‘help do’ behaves as a complex predicate, rather than a verb and its object. This is also true of other predicate plus light verb ‘do’ combinations throughout this section.

⁹In most cases the passive and reflexive suffixes overlap; but there are a few verbs in which they diverge: e.g. *döv-ül* ‘to be beaten’ vs *döv-ün* ‘beat oneself/one’s chest’; *giy-il* ‘be worn’ vs *giy-in* ‘get dressed’; *ört-ül* ‘be covered’ vs *ört-ün* ‘cover oneself’. See Key (2013) for a thorough discussion.

- b. *Eski-den ikisi tarafından hep yüz yüze gör-üş-ül-ür-dü.
 old-ABL the.two by always in preson see-RECP-PASS-AOR-PST
 ‘It used to be met by the two in person all the time in the past.’

Verbs whose sole internal argument is a (non-case-marked) finite clause also cannot passivize:

- (16) a. Onlar [ben Ali-yi gör-dü-m] san-ıyor-lar.
 they I Ali-ACC see-PST-1SG think-PROG-3PL
 ‘They think that I saw Ali.’
- b. *Onlar tarafından [Ben Ali-yi gör-dü-m] san-ıl-ıyor.
 they by I Ali-ACC see-PST-1SG think-PASS-PROG
 ‘That I saw Ali is thought by them.’

Verbs that take a nominalized clause pattern with those that take a nonclausal DP: if the complement is accusative in the active, the verb can be passivized, like *bilmek* ‘know’, (17), whereas if the complement is oblique in the active, the verb cannot be passivized, like *inanmak* ‘believe’, which takes a dative clause, (18).

- (17) a. Herkes [ben-im biber-i sev-me-diğ-im]-i bil-ir.
 everyone I-GEN pepper-ACC like-NEG-NMLZ-1SG.POSS-ACC know-AOR
 ‘Everyone knows that I don’t like peppers.’
- b. [Ben-im biber-i sev-me-diğ-im] herkes tarafından
 I-GEN pepper-ACC like-NEG-NMLZ-1SG.POSS everyone by
 bil-in-ir.
 know-PASS-AOR
 ‘That I don’t like peppers is known by everyone.’
- (18) a. Herkes [uzaylı-lar-ın var ol-duğ-un]-a inan-ır.
 everyone alien-PL-GEN exist-NMLZ-3SG.POSS-DAT believe-AOR
 ‘Everyone believes that aliens exist.’
- b. * [Uzaylı-lar-ın var ol-duğ-un]-a herkes tarafından
 alien-PL-GEN exist-NMLZ-3SG.POSS-DAT everyone by
 inan-ıl-ır.
 believe-PASS-AOR
 ‘That aliens exist is believed by everyone.’

Verbs that are unergative or unaccusative also lack a structurally case marked object and so cannot be passivized in Turkish, as illustrated in (19) and (20) respectively.

- (19) a. Çocuk-lar bütün gece dans et-ti-ler.
 child-PL whole night dance do-PST-PL
 ‘The children danced the whole night.’
- b. *Bütün gece çocuk-lar tarafından dans ed-il-di.
 whole night child-PL by dance do-PASS-PST
 ‘It was danced the whole night by the children.’ (Özsoy 2009, 263)
- (20) a. Kaza-lar-da adam-lar öl-ür-ler.
 accident-PL-LOC man-PL die-AOR-PL
 ‘Men die in accidents.’
- b. *Kaza-lar-da adam-lar tarafından öl-ün-ür.
 accident-PL-LOC man-PL by die-PASS-AOR
 ‘It is died by men in accidents.’

When a (cognate) object is added to an unergative verb, passivization becomes possible; thus in (21) passivization of ‘run’ is grammatical only in the presence of ‘race’.¹⁰

- (21) a. Ali (koşu-yu) koş-tu.
 Ali race-ACC run-PST
 ‘Ali ran (the race).’
- b. *Ali tarafından koş-ul-du.
 Ali by run-PASS-PST
 ‘*It/There was run by Ali.’
- c. Koşu Ali tarafından koş-ul-du.
 race Ali by run-PASS-PST
 ‘The race was run by Ali.’

Further evidence that the possibility for passivization is indeed determined by the presence of a structurally case marked object, rather than being lexically determined, comes from restructuring. George and Kornfilt 1977 argue that *iste-* ‘want’, *başla-* ‘begin’ and *çalış-* ‘try’ in Turkish can function not only as control verbs but also as restructuring verbs, presenting evidence from scrambling, rightward movement and the (im)possibility of embedded temporal adverbs. Most relevantly for our purposes, they also show that passivization

¹⁰Similarly, when a transitive verb is detransitivized through the reflexive suffix or the reciprocal suffix, passivization becomes impossible, as shown earlier in (14) and (15). See Kornfilt 1997 on these suffixes.

of the restructuring verb yields a long passive (see Wurmbrand 2001 on restructuring and long passives in German). Thus, in (22a), the ‘applaud’ embedded under ‘want’ has an accusative thematic object, allowing passivization of ‘want’ in (22b). The embedded thematic object raises to become the matrix nominative grammatical subject; note that the ‘by’-phrase realizes the thematic subject of ‘want’, not ‘applaud’.¹¹

- (22) a. *dinleyici-ler [yazar-lar-ı alkışla-mak] isti-yor-lar.*
 audience-PL author-PL-ACC applaud-INF want-PROG-3PL
 ‘The audience wants to applaud the authors.’ (George and Kornfilt 1977, 66)
- b. *yazar-lar (dinleyici-ler tarafından) [alkışla-n-mak] iste-n-iyor-lar.*
 author-PL audience-PL by applaud-PASS-INF want-PASS-PROG-3PL
 ‘The authors were wanted to be applauded by the audience.’ (George and Kornfilt 1977, 68)

In contrast, when the embedded predicate lacks a structurally case marked object, passivization of the matrix verb becomes impossible. In the following, ‘board’ takes a dative object, so matrix ‘want’ cannot be passivized.

- (23) **Hasan tarafından [otobüs-e bin-il-mek] iste-n-di.*
 Hasan by [bus-DAT board-PASS-INF] want-PASS-PST
 ‘The bus was wanted to be boarded by Hasan.’

Thus, it is the presence of a structural case marked object that is crucial in allowing passivization, not the identity of the lexical verb itself.

2.1.2 Turkish Impersonals

Importantly, verbs lacking a structurally case-marked object can in fact be affixed with the passive suffix, provided that no ‘by’-phrase is included. I provide an example below for each predicate type.

- (24) Pseudo-incorporated object

¹¹George and Kornfilt 1977 argue that the passive morpheme on the embedded verb is due to a morphological copying operation rather than independent passivization of the embedded predicate. See also Wurmbrand and Shimamura 2017 for a recent implementation of such a copying operation.

Hızlı kitap oku-n-ur.
quickly book read-PASS-AOR
'One does book-reading quickly.'

(25) Oblique object

Her gece top-a vur-ul-ur.
every night ball-DAT kick-PASS-AOR
'One kicks the ball every night.'

(26) Reflexive

Bu dere-de yıka-n-ıl-ır.
this river-LOC wash-REFL-PASS-AOR
'One has a bath in this river.'

(27) Reciprocal

Eski-den hep yüz yüze gör-üş-ül-ür-dü.
old-ABL always in person see-RECP-PASS-AOR-PST
'People used to meet always in person in the past.'

(28) Unergative

Her gece dans ed-il-ir.
every night dance do-PASS-AOR
'One dances every night.'

(29) Unaccusative

Türkiye-de her gün trafik kaza-lar-ı-nda öl-ün-ür.
Turkey-LOC every day traffic accident-PL-CM-LOC die-PASS-AOR
'In Turkey it is died in traffic accidents every day.' (Nakipoğlu-Demiralp 2001, 140)

As an aside, note that Nakipoğlu-Demiralp 2001 argues that the aorist is required for impersonals (her "impersonal passives") that are unaccusative, but other tense/aspect combinations are possible for those that are unergative. My investigation accords with this, with two additions. First, the progressive may be used instead of the aorist, due to an ongoing progressive to imperfective shift; thus the progressive is extended to the domain of the imperfective aorist (see Kornfilt 1997, 339-340, Deo 2015, i.a.). Second, verbs with pseudo-incorporated or oblique objects pattern with unergatives, suggesting that the distinction is

due to the base-generated position of the impersonal as thematic object or thematic subject. I leave further discussion of the relevance of tense/aspect to future research.

(30) Finite clause

[Ben Ali-yi gör-dü-m] san-ıl-ıyor.
I Ali-ACC see-PST-1SG think-PASS-PROG
'People think that I saw Ali.'

Such constructions have been analysed in the literature as impersonal passives, that is passives in which the thematic subject is indeed demoted, but there is no promotion to the grammatical subject position (Özkaragöz 1986, Kornfilt 1997, Nakipoğlu-Demiralp 2001, Öztürk 2005, Özsoy 2009, Kiparsky 2013). In contrast, I argue that these are impersonals, in which no demotion has taken place; rather the missing argument is syntactically projected as a null impersonal pronoun.¹² I provide eight arguments supporting an analysis whereby the thematic subject of the passive is demoted, whereas the thematic subject (or thematic object in the case of unaccusatives) of the impersonal is syntactically present as a null impersonal pronoun.

2.1.3 Status of the Initiator in Turkish Passives vs Impersonals

We have already seen the first argument in (9b), (10b), (14b), (15b), (16b), (19b), (20b) versus (8b) – a 'by'-phrase is impossible in the impersonal, but possible in the passive, indicative of demotion in the latter but not the former. While some languages have been claimed to exhibit passives but no 'by'-phrases, Turkish crucially does have 'by'-phrases, but these are limited to predicates that take a structurally case marked predicate in the active. The present analysis explains this pattern – 'by'-phrases are possible when the thematic subject is demoted, in passives, but not when the thematic subject is projected as an impersonal pronoun, in impersonals.

Note that for some languages it has been suggested that 'by'-phrases are disallowed in impersonal passives, e.g. Icelandic. I argue that this alternative analysis of the distribution

¹²This analysis is also proposed by Maling 2010, on the basis of the first two arguments presented here, as well as the aspectual properties mentioned above; thank you to Joan Maling for alerting me to this paper.

of ‘by’-phrases cannot carry over to Turkish. As mentioned in footnote 5 above, I have consulted two native speakers of Turkish with a more permissive grammar than my ten primary consultants; for these speakers, verbs with oblique or pseudo-incorporated objects may undergo passivization, unergatives may marginally do so, and unaccusatives, reflexives and reciprocals cannot. These two speakers do not allow ‘by’ phrases with unaccusative, reflexives and reciprocals impersonals, but do allow ‘by’ phrases with impersonal passives with oblique and pseudo-incorporated objects, demonstrating that there is not a general restriction against ‘by’ phrases with impersonal passives in the language. (I annotate the first example as % to remind the reader that it is ungrammatical in the grammar of my primary consultants.)

(31) % Top-a çocuk-lar tarafından vur-ul-du.
 ball-DAT child-PL by kick-PASS-PST
 ‘The ball was kicked by the children.’

(32) * Savaş-ta çocuk-lar tarafından öl-ün-ür.
 war-LOC child-PL by die-PASS-AOR
 ‘It is died by the children in the war.’

It is also worth noting that ‘by’-phrases are possible in impersonal passives in Icelandic, provided that the agent expresses new information and/or is phonologically heavy (Ingason et al. 2016).¹³ For example, in the following scenario, the agent is both heavy and new information and the impersonal passive with a ‘by’-phrase is not only grammatical but in fact preferred over the active.

(33) Context: What happened when inflation went up after the wall fell?
 a. Það var stigið á bremsurnar [af sameinuðum seðlabanka Austur- og
 there was stepped on the.brakes [by united central.bank East- and
 Vestur- þýskalands].
 West- Germany]
 ‘The United Central Bank of East and West Germany hit the brakes.’

¹³Ingason et al.’s (2016) speculation that the issue is one of usage seems quite plausible; the speaker has a choice between the active and the passive. Promotion of the theme to subject position (and hence to the ‘aboutness’ topic) provides a motivation to choose the passive, as does leaving the agent unspecified. Neither of these motivations apply to an impersonal passive with a ‘by’-phrase; this construction then is facilitated when there is some other motivation to use the passive.

(Lit: ‘There was stepped on the brakes by the United Central Bank of East and West Germany.’)

- b. ?Sameinaður seðlabanki Austur- og Vestur- þýskalands steig á united central.bank East- and West- Germany stepped on bremsurnar. the.brakes
‘The United Central Bank of East and West Germany hit the brakes.’ (Ingason et al. 2016, 49)

In Turkish, on the other hand, manipulating the discourse status and phonological weight of the agent does not facilitate inclusion of the ‘by’-phrase; it remains ungrammatical regardless. The following example illustrates.¹⁴

(34) Context: What happened when inflation skyrocketed?

Ekonomi-de (*Merkez Bankası ve geçici hükümet tarafından) fren-e
economy-LOC central bank and interim government by brake-DAT
bas-ıl-dı.
step-PASS-PST

‘The Central Bank and the interim government hit the brakes in the economy.’

(‘One stepped on the brake on the economy (*by the Central Bank and the interim government).’)

I therefore maintain that the availability of a ‘by’-phrase is a valid test for passive agent demotion in Turkish.

Second, while the passive may demote a non-human thematic subject, the impersonal may not. Instead, it patterns like overt impersonal pronouns in requiring a human interpretation (cf Italian *si*, German *Man*, English *one*). Thus, the following cannot be interpreted

¹⁴Given that ‘by’-phrases in Turkish are medial, rather than final as in Icelandic, we might expect rather that new but phonologically light agents would facilitate inclusion of a ‘by’-phrase. The following illustrates that that is also not the case:

(i) Context: What happened when inflation skyrocketed?

Ekonomi-de (*biri tarafından) fren-e bas-ıl-dı.
economy-LOC someone by brake-DAT step-PASS-PST

‘Someone hit the brakes on the economy.’

(‘One stepped on the brake on the economy (*by someone).’)

as passives since they are unergative, and are semantically anomalous as impersonals since the predicate takes a non-human thematic subject.

- (35) a. # Dağ-lar-da ulu-n-uyor.
forest-PL-LOC howl-PASS-PROG
'One howls in the mountains.'
- b. # Çöl-ler-de hısla-n-ıyor.
desert-PL-LOC hiss-PASS-PROG
'One hisses in the deserts.'

On the other hand, a predicate that may take a human thematic subject can be used as impersonal. This is illustrated with an unergative predicate and a verb with a reflexive suffix, respectively.

- (36) a. Çayır-lar-da koş-ul-ur.
field-PL-LOC run-PASS-AOR
'People run in the fields.' (Biktimir, 1986, 60)
NOT: animals/creatures generally
- b. Bu dere-ler-de hep yıka-n-il-ir.
this river-PL-LOC always wash-REFL-PASS-AOR
'People take a bath/wash themselves in these rivers.'
NOT: animals/creatures generally

Passives, on the other hand, do allow nonhuman thematic subjects, even without a 'by'-phrase.¹⁵ In (37), the most natural interpretation of the thematic subject is nonhuman.

- (37) Ali orman-da yürü-r-ken ısır-ıl-dı.
Ali forest-LOC walk-AOR-WHILE bite-PASS-PST
'While walking in the forest, Ali was bitten.'

Impersonal passives in, for example, Dutch and German have also been claimed to require a human agent. This is not a plausible alternative analysis for the Turkish pattern. The two Turkish speakers mentioned above that allow impersonal passives do allow nonhuman agents

¹⁵Cf Kiparsky 2013, which claims that a nonhuman thematic subject of the passive crosslinguistically is only possible when specified through a 'by'-phrase. Note that the most natural interpretation of the English translation is also with a nonhuman thematic subject, indicating that the claim is also incorrect for English.

of these impersonal passives. The following illustrates (see also the example in footnote 45) (Again, this is ungrammatical for my primary consultants.)

- (38) % Çöl-ler-de yılan-lar tarafından hısla-n-ıyor.
 desert-PL-LOC snakes by hiss-PASS-PROG
 ‘It is hissed by snakes in the deserts.’

In addition, note that nonhuman agents of impersonal passives are possible in Dutch and German, provided that the nonhuman agents have control over the event (Primus 2011), as illustrated in the following.

- (39) a. Dutch

Maar goed, gepiept wordt er al lang niet meer. De muizen hebben zich, met de rest van de muizenfamilie, met stille trom uit mijn leven teruggetrokken.

‘Well, there has long been no squeaking any more. The mice and all the rest of the mouse family have disappeared from my life silently.’

- b. German

Gestunken wird bei starkem Erschrecken, in Situationen der Panik. Der Gestank soll eine abschreckende Wirkung auf Feinde haben [über Frettchen.]

‘Stinking occurs as a reaction to strong fright, in panic situations. The ill smell is supposed to have a repelling effect on enemies [about ferrets].’ (Primus 2011, 91)

Such examples in Turkish, in contrast, are semantically anomalous, as we predict.

- (40) a. # Burada uzun zamandır ciyakla-n-mı-yor. Fare-ler ve öteki bütün
 here long time squeak-PASS-NEG-PROG mouse-PL and other all
 kemirgen-ler hayat-ım-dan sessizce yok ol-du-lar.
 rodent-PL life-1SG-ABL quietly disappear-PAST-PL
 ‘There hasn’t been squeaking here in a long time. The mice and all the other rodents have disappeared from my life silently.’ (‘One hasn’t squeaked here in a long time.’)
- b. # Büyük bir korku karşısında koku sal-ın-ır. Bu kötü koku-nun
 big a fright against smell release-PASS-PAST this bad smell-GEN

düşman-lar-a karşı püskürtücü bir etki yarat-ma-sı
 enemy-PL-DAT against repelling a effect create-NMLZ-POSS
 bekle-n-ir.
 expect-PASS-AOR

‘Stinking occurred as a reaction to strong fright. The bad smell is expected to create a repelling effect against enemies.’ (‘One released a smell against a big fright’)

Thus, the demoted agent of the passive may be nonhuman in Turkish, but the impersonal pronoun must be human. This test patterns with the ‘by’-phrase test in diagnosing passivization.

The third argument comes from control. The impersonal agent may be controlled PRO, supporting its analysis as syntactically projected. Three examples follow. Note that these involve control rather than restructuring. The embedded predicates cannot undergo passivization, as the first has a dative object, the second is an unergative and the third is a reflexive. Furthermore, while ‘want’ in the first example can function as a restructuring predicate, ‘get used to’ in the second cannot.¹⁶ It is also worth pointing out that both ‘want’ and ‘get used to’ are not in the class of predicates that are expected to exhibit predicative control,¹⁷ and that predicative control is not expected with an embedded temporal adverb distinct from the matrix as in (41d) (cf Chierchia 1995b on Italian impersonal *si*); see Landau 2015 for recent discussion.¹⁸

- (41) a. IMP_{*i*} [PRO_{*i*} otobüs-e bin-il-mek] iste-n-di.
 [PRO bus-DAT board-PASS-INF] want-PASS-PST
 ‘One wanted to board the bus.’
- b. IMP_{*i*} [PRO_{*i*} dans ed-il-me]-ye alış-ıl-dı.
 [PRO dance do-PASS-INF]-DAT get.used.to-PASS-PST
 ‘One got used to dancing.’

¹⁶Specifically, it does not pattern as restructuring according to the tests established for Turkish in George and Kornfilt 1977, cited above. Also note that ‘get used to’ is not a predicate that is crosslinguistically expected to pattern as a restructuring verb, see e.g. Wurmbrand 2001, 6-9.

¹⁷that is, a structure that achieves the semantics of control without a controlled PRO.

¹⁸Control is indeed required here, rather than this being accidental identity of two subjectless clauses. For example, in the natural context in which the tour bus drivers want the passengers to board the bus, (41a) cannot be used, since the ‘wanters’ (bus drivers) and ‘boarders’ (passengers) differ.

- c. Uzun bir koşu-dan sonra hep IMP_i [PRO_i iyice yıka-n-(1l)-mak]
 long a run-ABL after always [PRO well wash-REFL-PASS-INF]
 iste-n-ir.
 want-PASS-AOR
 ‘One always wants to take a good bath after a long run.’
- d. IMP_i [PRO_i yarın ayrıl-m-mak] iste-n-di, ama yarın için
 [PRO tomorrow leave-PASS-INF] want-PASS-PST but tomorrow for
 hava tahmini çok kötü.
 weather forecast much bad
 ‘One wanted to leave tomorrow, but the weather forecast for tomorrow is too bad.’

As expected, ‘by’-phrases cannot be added to (41), whether related to the embedded or the matrix predicate.

Note that the Turkish impersonal here provides us an important glimpse into the properties of impersonal pronouns. McCloskey 2007, 835 reports that “[o]ne of the threads which runs all through the literature on arbitrary [impersonal] pronouns is the intuition that such pronouns are similar to, or identical with, the ‘arbitrary’ understanding of PRO”. He demonstrates that the Irish null impersonal pronoun can act as a controller (McCloskey 2007, 829) and that in finite contexts impersonal pronouns can only serve as antecedents for impersonal pronouns, not personal (McCloskey 2007, 835); these two facts together suggest that PRO is impersonal when controlled by an impersonal pronoun. He further demonstrates that the Irish null impersonal pronoun is treated as equivalent to arbitrary PRO for the identity condition required for ellipsis licensing (McCloskey 2007, 835). In Irish, though, it is not possible to directly demonstrate that the null impersonal pronoun can be PRO, since the presence of the impersonal pronoun is identified through designated agreement with finite T.¹⁹ In Turkish, however, the morphology identifying the presence of the impersonal pronoun is independent of finiteness (see below for its low placement within the clausal spine). We therefore have the rare opportunity to confirm that the impersonal pronoun can indeed serve as controlled PRO. (See below for the analysis of impersonals, which explains this

¹⁹In many other languages, of course, the impersonal pronoun is overt and does not trigger designated morphology within the clausal spine, so also cannot be visible in nonfinite control clauses.

property of the impersonal pronoun.)

The thematic subject of a passive, in contrast, cannot be controlled PRO, indicating that it is syntactically unprojected.²⁰ (Note that these verbs do not have an exceptional case marking use in Turkish, see Kornfilt 1997, and so these are not grammatical as such.)

- (42) a. *Hasan [kitap hızlı oku-n-mak] iste-di.
Hasan book quick read-PASS-INF want-PST
'Hasan wanted to read the book quickly.'
- b. *Hasan [kitap hızlı oku-n-ma]-ya alış-tı.
Hasan book quick read-PASS-INF-DAT get.used.to-PST
'Hasan got used to reading the book quickly.'

While the nominative case on the theme could also be a source of ungrammaticality in 42, control remains ungrammatical when the theme has an independent source of case. Nominalization of the embedded clause above the passive morpheme provides genitive case for the theme, but the resulting structure does not involve control, as illustrated by the felicitous continuation.

- (43) Hasan kitab-ın oku-n-ma-sı-nı iste-di, ama (o) kendisi oku-mak
Hasan book-GEN read-PASS-NMLZ-POSS-ACC want-PST but he himself read-NMLZ
iste-me-di.
want-NEG-PST
'Hasan wanted the book to be read, but he himself didn't want to read it.'

Fourth, consider binding of the reciprocal *birbir(ler)i*.²¹ As background, I point out that while the reflexive *kendi* is logophoric, the reciprocal *birbir(ler)i* is not (Kornfilt 1997, 2001). For example, Kornfilt provides (44a) as illustration of the logophoric licensing of *kendi*; in (44b) we see that *birbir(ler)i* cannot be so licensed.

²⁰One might think that if the passive thematic subject were obligatorily projected as an existential quantifier phrase, and could not be projected as PRO, this fact would also follow. Such an analysis would need to provide an explanation for this restriction, and would need alternative explanations for the additional properties in this section.

²¹This can also appear as *birbiri*, without the plural suffix, to my knowledge without consequence though speakers seem to have different preferences.

- (44) a. [Oya-nın kendi-si-ni_i beğen-me-si] Ahmed-in_i hoş-un-a
 Oya-GEN self-3POSS-ACC admire-NMLZ-3POSS Ahmet-GEN liking-3POSS-DAT
 git-ti.
 go-PST
 ‘Oya’s admiring self_i was to Ahmet_i’s liking.’ (Kornfilt, 2001, 204)
- b. * [Öğrenci-nin birbir(ler)i-ni_i beğen-me-si] öğretmen-ler-in_i
 student-GEN each.other-ACC admire-NMLZ-3POSS teacher-PL-GEN
 hoş-un-a git-ti.
 liking-3POSS-DAT go-PST
 ‘The student’s admiring each other_i was to the teachers_i’ liking.’

Further illustration is provided in the following examples, using typical logophoric contexts (see Sells 1987 i.a.); these examples use the reciprocal in the dative benefactive, (45), and postpositional benefactive, (46), constructions that I employ in the test cases below.²²

- (45) a. Zavallı [Hasan ve Ali]_i. *Anne-ler-i_i birbir(ler)i-ne_i pilav pişir-me-yecek.
 poor Hasan and Ali mother-PL-POSS each.other-DAT pilaf cook-NEG-FUT
 ‘Poor [Hasan and Ali]_i. Their_i mother won’t cook pilaf for each other_i.’
- b. *Çocuk-lar_i [anne-ler-i-nin birbir(ler)i-ne_i pilav
 child-PL mother-PL-POSS-GEN each.other-DAT pilaf
 pişir-me-yeceğ-i-nden] kork-uyor-lar.
 cook-NEG-FUT-POSS-ABL fear-PROG-PL
 ‘The children_i are afraid that their_i mother won’t cook pilaf for each other_i.’
- (46) a. Zavallı [Hasan ve Ali]_i. *Anne-ler-i_i birbir(ler)i_i için pilav pişir-me-yecek.
 poor Hasan and Ali mother-PL-POSS each.other for pilaf cook-NEG-FUT
 ‘Poor [Hasan and Ali]_i. Their_i mother won’t cook pilaf for each other_i.’
- b. *Çocuk-lar_i [anne-ler-i-nin birbir(ler)i_i için pilav
 child-PL mother-PL-POSS-GEN each.other for pilaf
 pişir-me-yeceğ-i-nden] kork-uyor-lar.
 cook-NEG-FUT-POSS-ABL fear-PROG-PL
 ‘The children_i are afraid that their_i mother won’t cook pilaf for each other_i.’

Note that, as expected, (45b) and (46b) are both grammatical with the logophoric reflexive ‘kendileri’ in place of the non-logophoric reciprocal ‘birbirleri’. Given that the reciprocal is

²²These are grammatical on the irrelevant interpretations ‘Their mothers_k won’t cook pilaf for each other_k’ and ‘The children are afraid that their mothers_k won’t cook pilaf for each other_k’.

not a logophor, but rather an anaphor that requires a syntactic binder, I use binding of the reciprocal as a test for syntactic projection.

The thematic subject in the impersonal behaves as syntactically projected in that it can bind the reciprocal. One illustration contrasts oblique themes with themes that are accusative in the active and nominative in the passive. The following attested examples involve the idiomatic expressions *birbiri-ne gir-* ‘fight tooth and nail’ and *birbiri-ne düş-* ‘fall out with each other’. The former consists of the lexical verb ‘enter’ and its dative reciprocal object ‘each other’, whereas the latter is composed of the lexical verb ‘fall’ and its dative reciprocal object. With the passive morpheme the structures must be impersonal, given the oblique object, and the reciprocal is bound by the impersonal subject.

- (47) a. Herkes-in gör-eceğ-i şekil-de birbiri-ne gir-il-ir mi?
 everyone-GEN see-NMLZ-ACC manner-LOC each.other-DAT enter-PASS-AOR Q
 ‘Why would people fight tooth and nail in a way everyone could see?’²³
- b. Küçük bir sorun-dan birbirleri-ne düş-ül-ür mü canım!
 small a problem-ABL each.other-DAT fall-PASS-AOR Q dear
 ‘Oh dear, why would people fall out with each other over a small problem!’²⁴

In contrast, the verb ‘beat’ takes an accusative theme in the active; with the passive suffix the structure is a passive and so the reciprocal theme is not bound, resulting in ungrammaticality.

- (48) * Birbir(ler)i döv-ül-dü-(ler).
 each.other beat-PASS-PST-PL
 ‘Each other was/were beaten.’

Another illustration uses reciprocal beneficiaries. In (49), the structures must be impersonal: in (49a) ‘pilaf’ is pseudo-incorporated, in (49b) ‘dance’ is unergative. The impersonal pronoun binds the reciprocal, and the sentences are grammatical.

- (49) a. Buralarda bayram-lar-da birbiri-ne pilav pişir-il-ir.
 here holiday-PL-LOC each.other-DAT pilaf cook-PASS-AOR
 ‘Around here, during holidays, people pilaf-cook for each other.’

²³Retrieved October 30, 2019 from [Mhttps://www.haber61.net/trabzonspor/sosyal-medyada-trabzonspor-yonetici-leri-birbirine-girdi-h298270.html](https://www.haber61.net/trabzonspor/sosyal-medyada-trabzonspor-yonetici-leri-birbirine-girdi-h298270.html)

²⁴Retrieved November 02, 2019 from [Mhttps://www.mumsemaforum.com/deyimler-ve-ozdeyisler/62498-birbirine-dusmek-deyiminin-anlami.html](https://www.mumsemaforum.com/deyimler-ve-ozdeyisler/62498-birbirine-dusmek-deyiminin-anlami.html)

- b. Buralarda düğün-ler-de birbiri-ne dans ed-il-ir.
 here wedding-PL-LOC each.other-DAT dance do-PASS-AOR
 ‘Around here, during weddings, it is danced for each other.’

The structure here is indeed anaphor binding rather than reciprocal predicate formation (cf Chierchia 1995b on Italian impersonal *si*). As mentioned earlier, reciprocal predicate formation uses the reciprocal suffix $-(I)\textit{s}$ (Kornfilt 1997, 159 notes that this is ‘not very productive’). Furthermore, the reciprocal need not be an argument of the predicate; (50) illustrates it embedded in a PP adjunct.

- (50) a. Buralarda bayram-lar-da birbiri için pilav pişir-il-ir.
 here holiday-PL-LOC each.other for pilaf cook-PASS-AOR
 ‘Around here, during holidays, people pilaf-cook for each other.’
- b. Buralarda düğün-ler-de birbiri için dans ed-il-ir.
 here wedding-PL-LOC each.other for dance do-PASS-AOR
 ‘Around here during weddings, it is danced for each other.’

Another example follows in (51), with the verb ‘to hug’ which takes the reflexive suffix in the ArAk clause (see below for the discussion of ArAk clauses), and a pseudo-incorporated predicate in the matrix clause.

- (51) [In the face of hardships and bad events...]
 Bu koloni-de birbiri-ne sar-ıl-ın-arak güç topla-n-ır.
 this colony each.other-DAT hug-REFL-PASS-ArAk power collect-PASS-AOR
 ‘In this colony people find strength by hugging each other.’

Binding of the reciprocal by the implicit thematic subject in the passive, in contrast, is impossible.²⁵

- (52) a. *Buralarda pilav bayram-da birbiri-ne pişir-il-di.
 here pilaf holiday-LOC each.other-DAT cook-PASS-PST
 ‘Around here during the holiday, pilaf was cooked for each other.’

²⁵Note that the reciprocal is not subject-oriented:

- (i) Ben çocuk-lar-a_i birbiri_i-ni göster-di-m.
 I child-PL-DAT each.other-ACC show-PST-1SG
 ‘I showed the children_i each other_i.’

- b. *Buralarda pilav bayram-da birbiri için pişir-il-di.
 here pilaf holiday-LOC each.other for cook-PASS-PST
 ‘Around here during the holiday, pilaf was cooked for each other.’

In sum, the thematic subject in the impersonal behaves as syntactically projected in that it can bind a reciprocal, while the thematic subject in the passive behaves as syntactically unprojected in that in cannot.

Fifth, we find a contrast between the thematic subject of passives and that of impersonals in the licensing of depictives.²⁶ The thematic subject of the impersonal licenses a depictive; this is illustrated here with a dative object verb and an unergative verb.

- (53) a. Tatil merkez-ler-i-nde, otobüs-e sarhoş bin-il-ir.
 vacation center-PL-CM-LOC bus-DAT drunk board-PASS-AOR
 ‘At vacation spots, one boards the bus drunk.’
- b. Sahil-ler-de, hep sarhoş koş-ul-ur.
 beach-PL-LOC always drunk run-PASS-AOR
 ‘On beaches, one always runs drunk.’
- c. Kan ver-me-ye aç mı gid-il-ir?
 blood give-NMLZ-DAT hungry Q go-PASS-AOR
 ‘Does one give blood (lit: go to blood-giving) hungry?’²⁷
- d. Bu sahil-de, üstsüz güneşlen-il-ir.
 this beach-LOC topless sunbathe-PASS-AOR
 ‘On this beach, one sunbathes topless.’

The thematic subject of the passive, in contrast, does not license a depictive.

- (54) a. *Mektup sarhoş yaz-il-dı.
 letter drunk write-PASS-PST
 ‘The letter was written drunk.’
- b. *Böylesine önemli karar-lar asla sarhoş tartış-il-ma-dı.
 such important decision-PL never drunk discuss-PASS-NEG-PST
 ‘Decisions of such importance were never discussed drunk.’

²⁶There is some debate on the licensing of depictives by the thematic subject of English passives; see for example Roeper 1987 and Landau 2010.

²⁷Retrieved October 18, 2019 from <https://www.kizlarsoruyor.com/diger/q9162475-kan-vermeye-ac-mi-gidilir-tok-mu-gidilir>.

- c. *Mektup aç mı yaz-ıl-dı?
 letter hungry Q write-PASS-PST
 ‘Was the letter written hungry?’
- d. *Bu kitap üstsüz oku-n-du.
 this book topless read-PASS-PST
 ‘This book was read topless.’

Turkish patterns like English in not allowing depictive licensing by the object of an adposition, so the ‘by’-phrase itself cannot license the depictive.

- (55) Ben araba-yı Murat için sarhoş sür-dü-m.
 I car-ACC Murat for drunk drive-PST-1SG
 ‘I drove the car drunk for Murat.’
- NOT: Murat was drunk
- YES: I was drunk.

The pattern of depictive licensing provides further evidence for projection of the thematic subject in the impersonal but not in the passive.

For the sixth argument, consider adverbial gerundives expressing simultaneity in which the verb is suffixed with *-arak*, henceforth ArAk clauses (see Özkarağöz 1980, Knecht 1985, Biktimir 1986, Kornfilt 1997).²⁸ The interpretation of the grammatical subject of the ArAk clause is determined by the grammatical subject of the matrix clause. The previous literature on the construction investigates restrictions related to the status of the subject as underlying versus derived, without fully resolving the issue. Examples that match in voice and in the status of the subjects as underlying or derived, however, are uniformly accepted as grammatical. The following illustrate active predicates with thematic subjects, transitive and unergative.

- (56) a. transitive initiator + transitive initiator
- Çocuk [sakız çiğne-yerek] anne-sin-i öp-tü.
 child gum chew-ARAK mother-3SG.POSS-ACC kiss-PST
 ‘The child kissed his mother (while) chewing gum.’

²⁸Note that there are other uses of *-arak*, see especially Kornfilt 1997.

- b. unergative initiator + unergative initiator

Kız [(top) oyna-yarak] şarkı söyle-di.
 girl ball play-ARAK song sing-PST

‘The girl (while) playing (ball), sang.’ (Özkaragöz 1980, 417)

Derived subjects are also possible, the following illustrate with the themes of active unaccusatives and passives.

- (57) a. unaccusative theme + unaccusative theme

Adam [sayıkla-yarak] öl-dü.
 man rave-ARAK die-PST

‘The man died raving.’ (Biktimir 1986, 62-63)

- b. passive theme + passive theme

Çocuk [okşa-n-arak] öp-ül-dü.
 child caress-PASS-ARAK kiss-PASS-PST

‘The child was kissed (while) being caressed.’ (Biktimir 1986, 62-63)

However, when the matrix grammatical subject is the theme of a passive, it does not allow for an ArAk clause with a null theme of an active.²⁹

- (58) *Gazete [anla-yarak] oku-n-du.
 newspaper understand-ARAK read-PASS-PST

‘The newspaper, (while pro) understanding (it), was read.’ (Özkaragöz 1980, 414)

Nor does a matrix theme of an active transitive allow for a ArAk clause with a null theme of an unaccusative:

- (59) *Adam çorba-yı [kayna-yarak] servis et-ti.
 man soup-ACC boil-ARAK service do-PST

‘The man served the soup (while it was) boiling.’

Crucially for our purposes, the thematic subject of a matrix impersonal allows for an ArAk clause with a null subject of an active verb, whereas the thematic subject of a matrix passive

²⁹Note that I have changed the verb in these examples to *anla* which is a better choice for ‘to understand’, in my estimation. (Özkaragöz 1980 uses *anlaş*.)

does not. Thus, (60) is grammatical because the matrix verb is unergative ‘speak’, hence must be an impersonal. (61) is ungrammatical because the matrix verb is transitive ‘call’, hence must be a passive.

(60) [Sakız çiğne-yerek] hoca-yla konuş-ül-maz.
 gum chew-ARAK teacher-with speak-PASS-NEG.AOR
 ‘One does not speak with the teacher while chewing gum.’ (Biktimir 1986, 64)

(61) * [Sakız çiğne-yerek] hoca öğrenci tarafından çağ[ı]r-ıl-maz.
 gum chew-ARAK teacher student by call-PASS-NEG.AOR
 ‘The teacher is not called by a student while (student is) chewing gum.’

The animacy of the theme grammatical subject in this example is not the decisive factor; a passive with an inanimate theme as the grammatical subject is also ungrammatical.

(62) * [Kahve iç-erek] gazete hoca tarafından oku-n-ur.
 coffee drink-ARAK newspaper teacher by read-PASS-AOR
 ‘The newspaper is read by a teacher while (teacher is) drinking coffee.’

(63) illustrates that the theme of a matrix unaccusative impersonal allows an ArAk clause with a null theme of an unaccusative, again indicating that the theme of the unaccusative impersonal is syntactically projected.

(63) [Sayıkla-yarak] öl-ün-ür.
 rave-ARAK die-PASS-AOR
 ‘One dies raving.’ (Biktimir 1986, 65)

I also examine quantificational variability effects, whereby the interpretation of an argument is determined by a quantificational adverb. (See Lewis 1975, Heim 1982, Diesing 1992, de Swart 1993, Chierchia 1995a.) Quantificational variability effects in other languages are found with impersonal pronouns but lacking with passive implicit agents (see Chierchia 1995b, Malamud 2013, Rezac and Jouitteau 2016, i.a., for discussion and analysis), and the Turkish shows exactly this pattern. In (64), ‘bump.into’ takes a dative object, and hence forms an impersonal whose subject shows quantificational variability effects. In (65), ‘push.around’ takes an accusative object in the active, and hence forms a passive whose subject does not show quantificational variability effects.

- (64) Istanbul-da, metrobüs durağı-nda genellikle yolcu-lar-a
 Istanbul-LOC metrobüs station-LOC usually passenger-PL-DAT
 çarp-ıl-ır.
 bump.into-PASS-AOR
 ‘In Istanbul, at metrobüs stops, one usually bumps into passengers.’
- (i) YES: most people bump into other passengers
 (ii) YES: people bump into other passengers at most times
- (65) Istanbul-da, metrobüs durağı-nda yolcu-lar genellikle it-il-ir.
 Istanbul-LOC metrobüs station-LOC passenger-PL usually push.around-PASS-AOR
 ‘In Istanbul, at metrobüs stops, passengers are usually pushed around.’
- (i) NOT: most people push around other passengers
 (ii) YES: people push around other passengers at most times

Finally, I examine sluicing effects in Turkish. In line with Merchant’s (2013) generalization, sluicing in Turkish obeys the voice matching constraint (see Chapter 3 for a comprehensive discussion of this generalization for Sason Arabic). This is illustrated in (66).

- (66) a. Kemal dün öldür-ül-dü, ama tam olarak kim *(tarafından)-dı
 Kemal yesterday kill-PASS-PST but exactly who *(by)-PST.3SG
 bil-mi-yor-um.
 know-NEG-PROG-1SG
 ‘Kemal was killed yesterday, but I don’t know *(by) who.’
- b. Dün biri Kemal-i öldür-dü, ama tam olarak kim *(tarafından)-dı
 yesterday someone Kemal-ACC kill-PST but exactly who *(by)-PST.3SG
 bil-mi-yor-um.
 know-NEG-PROG-1SG
 ‘Someone killed Kemal yesterday, but I don’t know *(by) who.’

As seen in (66), and already noted in İnce (2006, also cited in Gračanin-Yüksek and İşsever 2011), in Turkish sluicing examples, the sluiced *wh*-phrase may appear with the tense marker. Consider (67).

- (67) Dün sen-i biri ara-dı, ama kim-di bil-mi-yor-um.
 yesterday you-ACC someone call-PST but who-PST.3SG know-NEG-PROG-1SG
 ‘Yesterday someone called you, but I don’t know who.’ (Gračanin-Yüksek and İşsever 2011: 15)

Turning to impersonals, we see that they pattern as active. (68) involves an unergative verb in the antecedent clause, thus patterning as impersonal; the remnant in the correlate cannot be a PP, in contrast to a canonical passive antecedent, which requires a PP remnant (cf. (66a)).

- (68) Dün parti-de çılgınlarca dans ed-il-di, ama tam olarak kim-ler
 yesterday party-LOC crazily dance do-PASS-PST but exactly who-PL
 (*tarafından)-dı hatırla-mı-yor-um.
 (*by)-PST remember-NEG-PROG-1SG
 ‘Yesterday people danced like crazy in the party, but I don’t remember exactly (*by) who.’³⁰

In summary, I have argued that verbs suffixed with passive morphology have two distinct structures. One is the passive, in which the thematic subject is demoted. The other is the impersonal, in which the thematic subject is syntactically projected as a null impersonal pronoun. We have seen eight tests supporting this analysis. The properties of passives and impersonals are summarized in Table 2.1.

	Passive	Impersonal
(i) ‘by’-phrase	✓	*
(ii) non-human argument	✓	*
(iii) controlled PRO	*	✓
(iv) reciprocal	*	✓
(v) depictives	*	✓
(vi) licensing the subject of an ArAk clause	*	✓
(vii) quantificational variability effects	*	✓
(viii) sluicing remnant	by who	who

Table 2.1: Passives vs impersonals in Turkish

The passive thematic subject may be realized in a ‘by’-phrase, may be non-human, cannot be controlled PRO, cannot bind a reciprocal, cannot license a depictive, does not allow for a null subject of an ArAk clause, is not subject to quantificational variability effects, and the sluicing remnant is realized as a ‘by’-phrase. The impersonal thematic

³⁰Note that in the absence of the postposition ‘by’, the tense marker merges with the *wh*-phrase (followed by vowel harmony), thus surfacing as *kim-ler-di* in this instance.

subject, in contrast, cannot be realized in a ‘by’-phrase, cannot be non-human, can bind a reciprocal, can be controlled PRO, can license a depictive, does allow for a null subject of an ArAk clause, is subject to quantificational variability effects, and behaves as active for sluicing, as such the sluicing remnant is realized as a DP. Of the two constructions, the passive is more restricted in its distribution, applying only to verbs that have a structural case marked object in the active.³¹

2.1.4 Passive of a Passive?

Now let us return to the *prima facie* passives of passives, and discover that the thematic subject is demoted through passivization, while the thematic object is syntactically projected as a null impersonal pronoun. Focusing first on the theme, we find that it is necessarily human, (69), and cannot be expressed in a ‘by’-phrase, (70).

- (69) a. # Burada tamir ed-il-in-ir.
 here repair do-PASS-PASS-AOR
 ‘Here one is repaired by one’ (Knecht 1985, 74)
- b. # Burada güd-ül-ün-ür.
 here herd-PASS-PASS-AOR
 ‘Here one is herded.’
- (70) a. Harp-te askerler tarafından vur-ul-un-ur.
 war-LOC soldiers by shoot-PASS-PASS-AOR
 NOT: ‘In war, soldiers are shot by one.’ (Knecht 1985, 74)
 YES: ‘In war, one is shot by soldiers.’
- b. Bu oda-da mahkum-lar tarafından döv-ül-ün-ür.
 this room-LOC prisoner-PL by beat-PASS-PASS-AOR
 NOT: ‘In this room, one beats prisoners.’
 YES: ‘In this room, one is beaten by prisoners.’

The grammatical interpretations of (70) illustrate that the thematic subject, in contrast, can

³¹I take this to be a low-level, language-particular syntactic fact, as languages differ in this regard; indeed, see footnote 5 for Turkish-internal variation. In the analysis of the passive developed later in the dissertation, such restrictions can be encoded in the selectional properties of the passive Voice head.

be expressed in a ‘by’-phrase. It may also be non-human, (71). (71b) is an attested example, in which the speaker is complaining about being bitten repeatedly by mosquitoes.³²

- (71) a. Orman-da (yılan-lar tarafından) sok-ul-un-ur.
 forest-LOC snake-PL by bite-PASS-PASS-AOR
 ‘In the forest, one is bitten (by the snakes).’
- b. on defa ısır-ıl-ın-ır mı?
 ten time bite-PASS-PASS-AOR Q
 ‘How could one be bitten ten times?’

Thus, in this construction, the theme is syntactically projected as an impersonal pronoun, while the thematic subject is demoted through the passive. It is thus an impersonal of a passive, not a passive of a passive. Therefore, we would have the following two structures, (72) with a ‘by’-phrase, and (73), interpreted existentially when the ‘by’-phrase is missing.

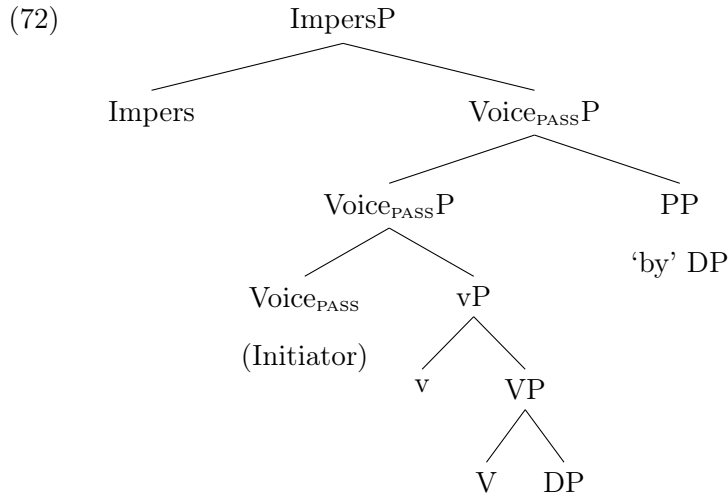

³²Retrieved Jan 28, 2017 from <https://tr.instela.com/bu-mevsimde-hala-ortalikta-gezen-sivrisinek-13409259>

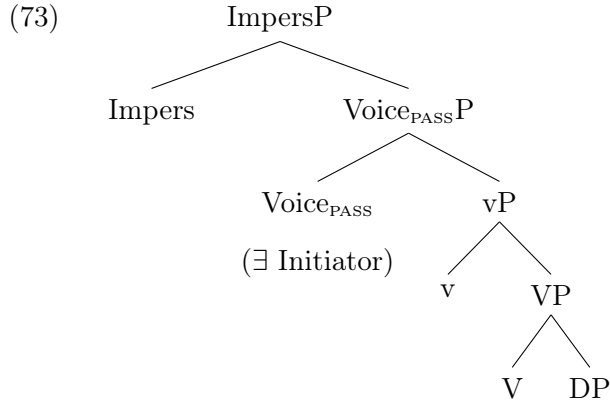

As predicted, the impersonal theme may be controlled by a matrix impersonal subject. In (74), the impersonal subject of ‘want’ controls the impersonal theme of ‘shoot’, whereas the demoted thematic subject of ‘shoot’ is expressed in a ‘by’-phrase.³³

- (74) Harp-te IMP_i [PRO_i kimse tarafından vur-ul-un-mak] iste-n-mez.
 war-LOC [anyone by shoot-PASS-PASS-INF] want-PASS-NEG.AOR
 ‘In war, one does not want to be shot by anyone.’

In addition, the impersonal theme in the impersonal of the passive may bind a reciprocal in a PP adjunct, (75).

- (75) Hastane-ler-de doktor-lar tarafından birbiri-nin yan-ı-nda tedavi
 hospital-PL-LOC doctor-PL by each.other-GEN side-3POSS-LOC treat
 ed-il-in-ir.
 do-PASS-PASS-AOR
 ‘In hospitals, people_i are treated by doctors beside each other_i.’

Finally, the theme in the impersonal of the passive also behaves as syntactically projected in that a depictive may be predicated of the theme.

- (76) Tatil-ler-de polis tarafından sarhoş yakala-n-ıl-ır.
 holiday-PL-LOC police by drunk catch-PASS-PASS-AOR
 ‘During holidays, people are caught drunk by the police.’

In summary, we have seen that the apparent double passive in Turkish does not involve passivization of a passive, demoting both the thematic subject and the theme. Instead, the

³³Control is indeed obligatory here. For example, this sentence cannot express the natural situation in which the soldiers’ loved ones back home do not want the soliders to be shot.

language uses a single suffix for both passives, in which the thematic subject of the verb is demoted, and impersonals, which are characterized by the presence of a null, impersonal pronoun syntactically projected in argument position. The apparent double passives have demotion of the thematic subject through the passive, triggering one iteration of the suffix, and an impersonal pronoun as the thematic object, triggering a second suffix. Crucially, the passive applies quite narrowly in the language, demoting only the thematic subject of verbs with a structurally case marked object in the active (for our primary consultants). Therefore, although Turkish appeared to counterexemplify Perlmutter and Postal’s proposed generalization that passives may not apply to passives, upon closer inspection it is revealed rather to strongly confirm this generalization.

2.1.5 Analysis of Impersonal

It is interesting to consider further details of the syntactic analysis of the Turkish impersonal marked with the ‘passive’ morpheme.³⁴ (For the semantics of the impersonal, see Rezac and Jouitteau 2016 for a promising approach, which treats the French impersonal *on* as a nonnovel indefinite.) As we have seen, the impersonal involves a null impersonal pronoun generated in argument position; in a transitive clause, it is generated as the external argument. In the following tree I adopt the proposal of Kratzer 1996 and much subsequent, whereby the external θ -role is introduced by a functional head Voice;³⁵ the active Voice selects for a DP specifier; I encode this selection using the feature $[\bullet D \bullet]$.³⁶

³⁴ The literature on impersonals in other languages is quite rich; in addition to chapter 3, see for example Cinque 1988, Chierchia 1995b, D’Alessandro 2007 on Italian *si*; Dobrovie-Sorin 1998 on several Romance languages; Holmberg 2010 on Finnish; Hoekstra 2010 on Frisian *men*; McCloskey 2007 on Irish, and Malchukov and Siewierska 2011 for a typological overview. Recent syntactic analyses (Egerland 2003, Fenger 2018, Ackema and Neeleman 2018, i.a.) classify impersonals into two types, one with more functional structure including English *one*, Frisian *men*, and Icelandic *maður*; and one with less, including German, Norwegian, and Danish, *man*. Within this bifurcation, the Turkish impersonal marked with the ‘passive’ morpheme patterns with the former type that contains less functional structure. Turkish also exhibits a second impersonal pronoun, *insan* ‘human’, which patterns with the latter type, with more functional structure. See section 2.3.

³⁵I leave aside as orthogonal, the functional projection vP, which introduces causative semantics; see for example Pykkänen 2008, Legate 2014.

³⁶The use of features for selection appears in Chomsky 1965; an early revival in the Minimalist framework is Adger 2003, with the formalism being adopted by a variety of researchers since; see also Müller 2010 for the bullet notation.

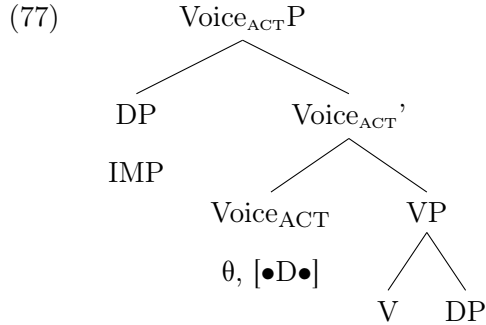

The impersonal pronoun may be generated in positions other than the thematic subject, notably the thematic object position, the impersonal may apply to unaccusatives, and to passives, (78). In (78) I assume the analysis of the passive to be developed in later in the dissertation, whereby the passive is a Voice head that introduces the external θ -role (following Legate 2014), but does not select for a DP specifier.

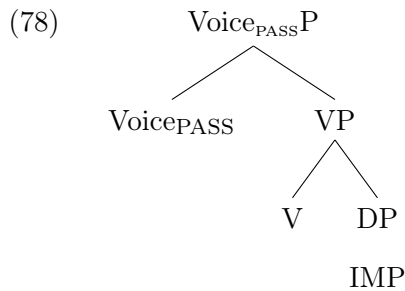

We must now explain the key fact we started with: the appearance, in the impersonal, of morphology syncretic with the passive morphology. Considering the placement of the impersonal morphology with respect to other morphemes in the clause, we find that the impersonal is adjacent to the passive, farther from the verbal root than the causative, and closer to the verbal root than aspect and tense. This is illustrated in (79); note that the causative *-dur* appears directly on the root, followed by the two ‘passive’ suffixes, followed by the progressive aspect *-uyor*, and finally the past tense *-du*.

- (79) Harp-te asker-ler tarafından vur-dur-ul-un-uyor-du.
 war-LOC soldier-PL by shoot-CAUS-PASS-PASS-PROG-PST
 ‘In war, one used to be made to shoot by soldiers.’

Assuming the Mirror Principle (Baker 1985), this morpheme ordering is straightforwardly accounted for once we propose a designated impersonal functional projection, ImpersP,

dominating VoiceP. The morphology glossed as ‘passive’ is the realization of Impers⁰ and of Voice_{PASS}⁰. (80) illustrates, taking into account the right-headed nature of Turkish (all other trees abstract away from headedness).³⁷

(80)

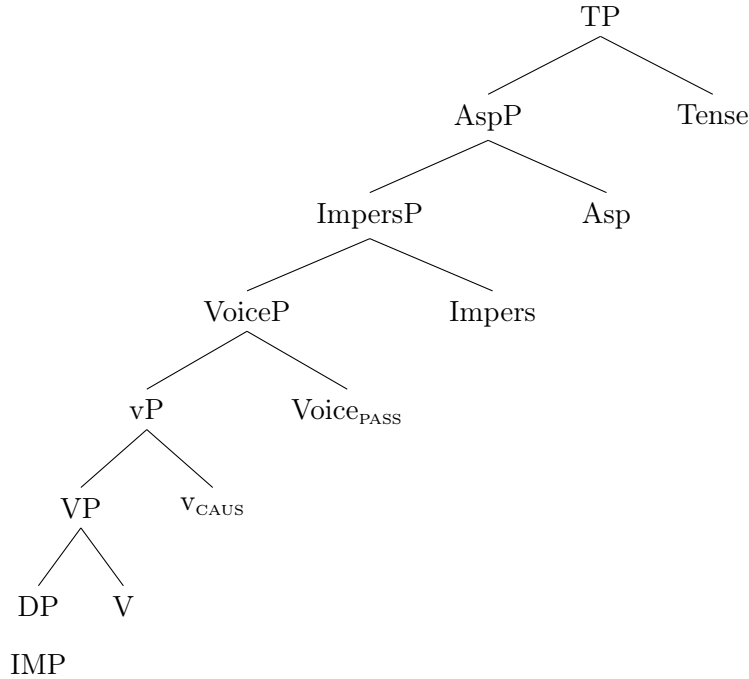

The morphological syncretism between Impers⁰ and Voice_{PASS}⁰ is not due to an identity of function in the synchronic grammar. Crosslinguistically, there is a common historical relationship between passives and impersonals, due to the overlap in the appropriate discourse situations for use of each; this can result in an overlap in the morphological realizations of the two constructions. (See Malchukov and Siewierska 2011, as well as the citations in footnote 34.) Unlike Voice_{PASS}⁰, Impers⁰ is not involved in argument introduction or suppression. Its function is rather to license the impersonal pronoun.

I treat the need for licensing of the impersonal pronoun like the need for licensing of

³⁷We cannot distinguish the passive morpheme from the impersonal morphophonologically. Erdem (2000) (see also Kornfilt 1991a for the same point) states that historically this morpheme was used as a middle/reflexive morpheme around the 7th-8th century in Old Turkic, and began to be used for both passive and impersonal functions in the 11th century. I place the impersonal above VoiceP to allow it to license the thematic subject, and to capture the generalization that the impersonal pronoun must be the highest argument in the VoiceP. See below for discussion. Note that ImpersP is not a subtype of VoiceP. ImpersP is not involved with θ -role assignment, since the impersonal pronoun is not limited to a particular thematic position. ImpersP must also be generated above the VoiceP that introduces the thematic subject to be able to license the highest projected argument, wherever it may be generated. Therefore, I do not pursue a VoiceP approach.

pro by agreement. This is supported by the fact that the overt impersonal in Turkish *insan* does not occur with the Impers^0 licensing head, as seen in (81).³⁸

- (81) İnsan oraya gid-(*il)-ir mi hiç?
 human there go-PASS-AOR Q ever
 ‘Why would one ever go there?’

Related also is the designated impersonal agreement that licenses the null impersonal pronoun in Irish in the same way that other agreement licenses pro in Irish (see McCloskey 2007). The literature on pro-drop is quite rich; the conception of it here falls into the class of proposals that treats the phenomenon as involving a null pronoun that requires licensing (including Rizzi 1982, 1986, McCloskey and Hale 1984, Jaeggli and Safir 1989, among many others), as opposed to poor agreement that requires licensing (as in Speas 1994, 2006), or rich agreement itself serving as the interpretable pronoun (e.g. Jelinek 1984, Alexiadou and Anagnostopoulou 1998).³⁹ Within this class of approaches, various implementations are compatible with the present proposal.

For concreteness, I adopt the distinction from Pesetsky and Torrego 2007 between interpretability and valuation of features, whereby an interpretable feature receives a semantic interpretation, while a valued feature is inherently specified on the lexical item rather than being determined in the course of the derivation. This system provides a natural encoding of the licensing relationship in terms of feature valuation.⁴⁰ The licenser, Impers^0 (or agreement in the case of pro-drop), bears valued but uninterpretable features, while the features of the impersonal pronoun are unvalued but interpretable. In the course of the derivation, Impers^0 undergoes agreement with the impersonal pronoun, and values its features. This allows the pronoun to be properly interpreted in the semantic component. Specifically, Impers^0 bears the uninterpretable valued ϕ -feature [human], while the impersonal pronoun bears interpretable unvalued ϕ -features; agreement between Impers^0 and the impersonal

³⁸See footnote 34 and section 2.3 on *insan*, which is not an overt realization of the null impersonal pronoun considered here, but rather patterns differently.

³⁹I leave aside as not germane, radical pro-drop, that is pro-drop that exists in the absence of identifying morphology. See e.g. Huang 1984, Jaeggli and Safir 1989, Neeleman and Szendrői 2007.

⁴⁰This solves the problem raised by Holmberg 2005 that the traditional idea of pro-drop being licensed by agreement does not mesh well with the features of the pronoun being interpretable and the features of agreement uninterpretable (Chomsky 1995b and subsequent).

pronoun results in the interpretable ϕ -features of the impersonal pronoun being valued to [human]. I implement this agreement operation through the operation Agree, Chomsky 2000 and subsequent, which operates on closest *c*-command. This approach minimally differs from Pesetsky and Torrego 2007 in that I allow both uninterpretable and unvalued features to serve as probes.⁴¹ I assume the operation Agree applies as follows:

(82) Agree

- a. An undetermined feature F (uninterpretable or unvalued) on a head H (probe) scans its *c*-command domain for the closest instance of F (goal) to establish a relation.
- b. The probe-goal relation repairs undetermined features, marking uninterpretable features for deletion from the LF branch, and sharing the valued features with the unvalued features.

Thus, the uninterpretable valued ϕ -feature of *Impers*⁰ initiates the Agree operation; it probes down the tree and finds the impersonal pronoun, whereupon *Impers*⁰ values the ϕ -feature of the impersonal pronoun, and the impersonal pronoun checks the uninterpretable feature of *Impers*⁰, marking it for deletion from the LF branch.⁴²

⁴¹Pesetsky and Torrego 2007 limits probes to unvalued features. This limitation is not crucial to the argumentation of that paper, however, and no empirical facts there hinge on it. An alternative approach could be whereby the unvalued ϕ -features of the impersonal pronoun initiate the probe operation, which applies upwards. This technical implementation of the agreement relationship between the impersonal pronoun and *Impers*⁰ also looks natural if upwards agree is an operation of the grammar; for related discussion, see Zeijlstra 2012, Preminger 2013, Wurmbrand 2014, i.a.

⁴²The lack of person/number/gender ϕ -features explains why the impersonal pronoun triggers default third person singular agreement. This proposal follows e.g. Egerland 2003 and Rezac and Jouitteau 2016 for the impersonal pronoun bearing only [human]; see references in footnote 34 for related alternatives.

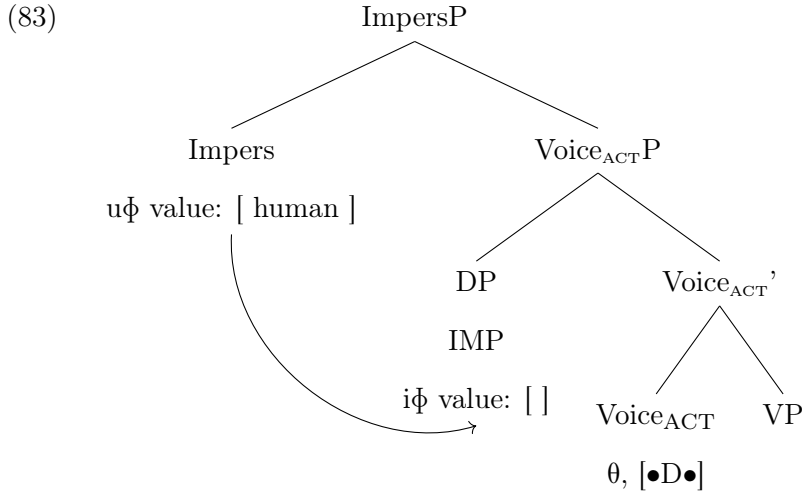

This proposal thus follows Landau 2015, which treats a variety of pronominals, including *pro* and *PRO*, as pronouns that lack features and therefore must acquire them in the course of the derivation (‘minimal pronouns’ in the sense of Kratzer 2009). The features acquired determine the behavior and pronunciation of the pronominal. We thereby also explain the fact from 41 above that the impersonal pronoun can be controlled *PRO*. The impersonal pronoun and *PRO* are fundamentally the same: pronouns with interpretable but unvalued features that must be valued in the course of the derivation. The impersonal pronoun is valued by *Impers*⁰, and *PRO* by its controller;⁴³ when the controller is an impersonal pronoun, as in 41, the features of *Impers*⁰ and the features of the controller are compatible, since the controller is itself an impersonal pronoun.⁴⁴

Finally, let us consider restrictions on the distribution of the impersonal pronoun. First, the impersonal pronoun must be the highest argument in the verb phrase; it cannot appear as the thematic object of an active transitive verb. (For this restriction on impersonal pronouns of this type in other languages, see footnote 34.)⁴⁵

⁴³indirectly for Landau 2015; see that work for details.

⁴⁴This discussion predicts that it should be possible for the embedded *ImpersP* (realized as the ‘passive’ morpheme) to be omitted in 41, with the [human] value of the ϕ -features coming solely from the controller. This indeed is the case, although the version with the embedded *ImpersP* is preferred.

⁴⁵This distribution is also reminiscent of the distribution of *PRO*, which is standardly assumed to be limited to the grammatical subject position (see e.g. Chomsky 1965, Zaenen et al. 1985, Chomsky and Lasnik 1993, Manning 1996, among many others). For my primary consultants, I have not been able to distinguish the highest argument from the grammatical subject; when the highest argument is an oblique, which cannot become the grammatical subject, a lower object simply moves over the oblique, thereby becoming both the highest argument and the grammatical subject. (See Tonyali 2015 for related discussion.) The two

- (84) Harp-te düşman hızlı vur-ul-ur.
 war-LOC enemy quickly shoot-PASS-AOR
 NOT: ‘In war, the enemy shoots one quickly.’
 (YES: ‘In war, the enemy is shot quickly.’)

For the Turkish null impersonal pronoun, I take this distribution to be due to locality – the impersonal pronoun must be the closest DP to its licenser outside the verb phrase (see Landau 2015 for a similar approach to the distribution of PRO). The following tree illustrates how this is captured on this approach. If the impersonal pronoun is generated in the object position of an active, transitive verb, the thematic subject is the most local DP to Impers⁰. Hence, when Impers⁰ probes for ϕ -features, (again, assuming Agree, which operates on closest c-command) it will find the thematic subject. However, the thematic subject has its own interpretable and valued ϕ -features (here the 3SG of ‘enemy’ in (84) for illustration), hence the agreement operation fails. Moreover, the impersonal pronoun in object position is left with unvalued features. The result is ungrammaticality.⁴⁶

can potentially be teased apart, however, for my two consultants who allow impersonal passives of verbs with oblique objects. One of these consultants suggested the following examples involving the verb ‘spit’, which takes a dative object in the active, and, for them, allows an impersonal passive with the dative object retained. The examples involve a visit to a zoo in which a man is angry because a llama spat at his daughter. (i) is the impersonal passive, and (ii) is the impersonal of the impersonal passive – the agent of ‘spit’ has been demoted and appears as a ‘by’-phrase, while the theme is an impersonal pronoun in the dative object position.

- (i) %Ben-im kız-ım-ın yüz-ü-ne tükür-ül-dü! Özür bekl-iyor-um!
 I-GEN.1SG daughter-1SG.POSS-GEN face-3SG.POSS-DAT spit-PASS-PST apology expect-PROG-1SG
 ‘My daughter’s face was spat at! I expect an apology!’
- (ii) %Bura-ya gir-me-yin! Bura-da lama-lar tarafından tükür-ül-ün-üyor.
 here-DAT enter-NEG-2SG here-LOC llama-PL by spit-PASS-PASS-PROG
 ‘Don’t go in here! One gets spat at by the llamas here.’

For this speaker, then, the impersonal need only be the highest argument, not the grammatical subject. The second consultant who allows (i), finds (ii) only marginally possible. I leave further discussion of this issue to future work.

⁴⁶Similar considerations rule out an active transitive with both the thematic subject and the thematic object as impersonal pronouns. Assuming that Impers⁰ can only license a single DP, the thematic object will fail to be licensed due to the intervention of the thematic subject, even if we allowed ImpersP to iterate.

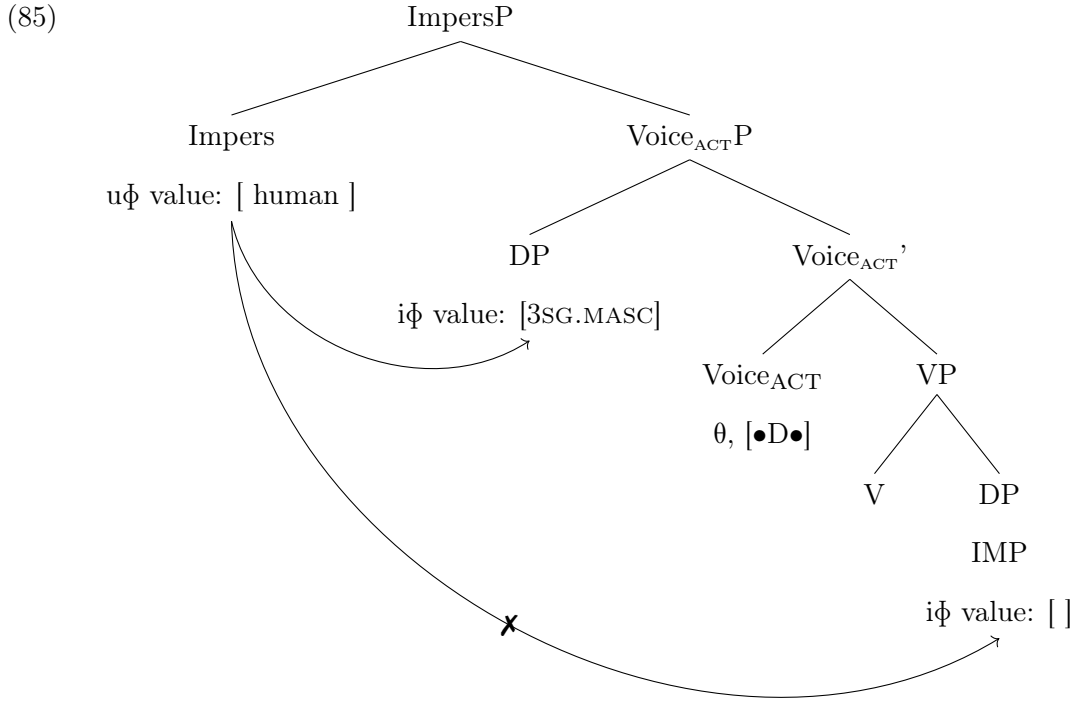

The second restriction on the distribution of the impersonal becomes apparent in considering verbs with a structurally-case marked object in the active. At first glance there seems to be an apparent complementarity in the passive and impersonal, in that for verbs with a structurally-case marked object in the active, the ‘passive’ morpheme must be a realization of passive voice, while for all other verbs, the ‘passive’ morpheme must be a realization of the impersonal. While this complementarity does hold true for my ten primary consultants, it is not a core property of these constructions. As reported above, I have encountered two speakers that have a more permissive grammar in allowing passive of a broader range of verbal predicate types; importantly, the range of the impersonal is not thereby narrowed for these speakers. For example, these speakers allow ‘kick’ with a ‘by’-phrase, illustrating the availability of a passive structure, or with an agent-licensed reciprocal, attesting to the availability of an impersonal structure. (I annotate the former as %, since it is ungrammatical for our other consultants.)

- (86) % Top-a çocuk-lar tarafından vur-ul-du.
 ball-DAT child-PL by kick-PASS-PST
 ‘The ball was kicked by the children.’
- (87) [Context: describing a particular rule in an altruistic game, in which for each kicking of the ball, the other person wins points.]
 Top-a birbiri için vur-ul-ur.
 ball-DAT each.other for kick-PASS-AOR
 ‘People kick the ball for each other.’

It remains a surprising fact, however, that the impersonal structure cannot apply to a transitive verb in the active, retaining accusative case on the object, for any of the speakers I consulted.

- (88) *Bu kitab-ı hızlı oku-n-ur.
 this book-ACC quickly read-PASS-AOR
 ‘One reads this book quickly.’

In this, the Turkish null impersonal is unlike impersonals discussed for other languages, and unlike the Turkish overt impersonal, *insan*, (see section 2.3). In fact, recent work on the related language Sakha (Turkic: Siberia) that builds on the present proposal (Tan and Köhler 2019) argues that the Sakha passive morpheme is also syncretic between a passive and an impersonal, but lacks the restriction seen in Turkish against transitive impersonals with accusative case, as shown in (89). This again suggests that the restriction is not a deep principle of (Turkic) grammar, but an unusual quirk of Turkish.

- (89) Sakha
- a. Passive
- yges-ter-(*1) keh-illi-bet-ter
 tradition-PL-(*ACC) break-PASS-NEG-PRES.3PL
 ‘Customs are not broken.’ (Tan and Köhler 2019, (2a))
- b. Impersonal
- yges-ter-ı keh-illi-bet-∅
 tradition-PL-ACC break-IMP-NEG-PRES.3SG

‘One does not break customs.’ (Tan and Köhler 2019, (2b))

The restriction seems related to the syncretism between the impersonal morpheme and the passive morpheme, but needs to be encoded into the grammar. For now I leave it as a stipulation: Impers⁰ selects for a VoiceP lacking accusative case assignment; the VoicePs associated with unergatives, reflexives, reciprocals, oblique object verbs, CP object verbs, and unaccusatives all meet this criterion. The VoiceP associated with regular transitive verbs does not.⁴⁷

To summarize, the null impersonal pronoun in Turkish is generated as the highest argument in the verb phrase and undergoes licensing with a designated functional projection generated above VoiceP. The head of this impersonal projection is syncretic with the passive morpheme, and may cooccur with it.

This section of the chapter has demonstrated that Turkish is not exemplar of a passive of a passive, but instead an impersonal of a passive, in which the theme is not demoted, but rather syntactically projected as a null impersonal pronoun.

2.1.6 Analysis of Passive

The previous section has shown that the Turkish construction that has been cited as evidence for the passive applying to passives had been misanalysed. The reanalysis demonstrated that Turkish (as well as Lithuanian and Sanskrit; see Legate et al. 2020) in fact confirms Perlmutter and Postal’s generalization that passives may not themselves undergo passivization. This necessitates an analysis of the passive that can capture this generalization. Specifically, the analysis of the passive must predict that the passive cannot iterate: demotion of the thematic subject through passivization cannot make the thematic object accessible for demotion on a second round of passivization.

Perlmutter and Postal’s own (1984) account depends on two proposed conditions, both

⁴⁷Alternative formulations are possible. For example, the impersonal pronoun could be prohibited from merging into the specifier of a Voice⁰ that assigns accusative case. In considering options, it is important to note, however, that the desideratum is ungrammaticality of an impersonal subject with this verb class, not grammaticality with a different case on the object (e.g. nominative, whether assigned or default). If an impersonal thematic subject were possible for these verbs with a nominative object, then these verbs would have passed all above tests for a projected impersonal pronoun above, contrary to fact.

of which must be simply stipulated. The analysis is couched in Relational Grammar, in which a passive involves demotion of an initial subject (referred to as a 1) to a prepositional adjunct (*chômeur*) and promotion of another clausal element to subject. The first condition required to rule out passives of passives is the 1-Advancement Exclusiveness Law,

(90) 1-Advancement Exclusiveness Law

The set of advancements to 1 in a single clause contains at most one member. (Perlmutter and Postal 1984, 84)

which prohibits promotion of multiple elements to subject within a clause. While this condition does not follow from anything in the theory, Perlmutter and Postal 1984 do provide considerable empirical argumentation for it. The second condition is the Motivated Chômage Law, which prevents demotion of the subject to adjunct status from applying in the absence of promotion of an element to subject status. This condition should prevent impersonal passives entirely, but instead they posit that impersonal passives involve promotion of a null dummy to subject position, motivating demotion of the subject to adjunct. Thus, in this framework, a passive of a passive would involve promotion of the theme to subject status and corresponding demotion of the agent to adjunct status, followed by a second step with promotion of a dummy to subject status and corresponding demotion of the theme to adjunct status. It is this second step that is ruled out by the combination of the Motivated Chômage Law, which prevents the theme from being demoted without promotion of something to subject status, and the 1-Advancement Exclusiveness Law, which prevents the dummy from promoting to subject status to allow demotion of the theme. This theory has been criticized for its reliance on the dummy, which is required on theory-internal grounds, but is not empirically motivated (Comrie 1977, Blevins 2003, i.a.). The fact that the two conditions that achieve the absence of passives of passives do not follow from independent properties of the theory also make it inadequate for our needs. Furthermore, see Legate 2012, 2014 for arguments against an analysis of the passive involving actual demotion of an argument from a subject position to adjunct status.

As mentioned above, Kiparsky 2013 considers passivization of passives to be possible, and

formulates his theory of passivization accordingly. The approach is couched within Lexical Decomposition Grammar (Stiebels 2002; Wunderlich 1997), which incorporates Optimality-Theoretic constraints. Passive is defined as “an affix that demotes (existentially closes) the most prominent Theta-role that is not already demoted” (Kiparsky 2013, 7). The system thus does not capture the fact that passives of passives are unattested. While the passive could be redefined in this system so as to be sensitive to the thematic subject θ -role rather than the most prominent θ -role, the lack of constraints on the possible definition of the passive eliminates any predictive power of the theory in this regard. Several other theories of the passive also suffer from this issue: the passive is simply defined as a lexical rule, and its formulation either predicts iteration, or could be easily modified to predict iteration. For example, the standard treatment of the passive in Lexical Functional Grammar (Bresnan 2001) defines passive as a lexical rule that suppresses the most prominent role; the most prominent unlinked role after passivization is the theme, so iteration can be predicted.⁴⁸ Similarly, Blevins 2003 employs technology from HPSG to directly identify the subject term linked to the first θ -role of a predicate, and to then define the Passive Lexical Rule to specifically eliminate this subject term (Blevins 2003, 512); changing the rule to apply to any subject term would predict passive iteration. Culicover and Jackendoff 2005, 203 in the framework of Simpler Syntax defines the passive as linking the highest ranking grammatical function with an oblique; passive iteration is expected. Examples multiply.

Turning to syntactic analyses of the passive, let us begin with Murphy 2014, which discusses the Turkish and Lithuanian constructions. Building on Müller 2014, Murphy 2014 proposes that passivization is a syntactic operation, *Slice*, which functions as the opposite of the structure building operation *Merge* (Chomsky 1995a), in that a constituent at the

⁴⁸An alternative LFG analysis is Kibort 2001. Arguments are assigned features based on their thematic roles; the passive is hypothesized to add [+r] to the highest argument of the predicate. If this argument is a thematic subject, [-o], the result is an oblique, [+r, -o]. If this argument is a thematic object, the result is the impossible [-r, +r]. Hence, passivization can only apply to demote thematic subjects, and passives of passives are not possible. Note that this is accomplished by ruling out demotion of themes, which should thereby also rule out antipassives (see Polinsky 2017 for a recent overview of antipassives) and any passives of unaccusatives. (The prediction for secondary objects, [+r], is less clear, since the passive rule would result in [+r, +r]). Additions to the system to accommodate antipassives or passives of unaccusatives are therefore likely to eliminate the explanation of the impossibility of passives of passives.

top of the tree is removed.⁴⁹ As a syntactic operation, Slice can iterate, first removing the thematic subject, then removing the thematic object (after it has raised to VoiceP); this is the analysis provided for the Turkish construction, assumed to be a passive of a passive. The analysis of passives through Slice therefore does not account for the lack of passives of passives crosslinguistically and so is not adequate to our needs. The theory also fails to predict other properties of the passive constructions considered here. The Slice operation is designed to capture the purported generalization that the passive agent behaves as present in the structure for relationships below its merged thematic position (binding, depictive licensing, control), but not above that position. As we have seen above, the passive agent in Turkish does not follow this pattern:⁵⁰ the passive agent may not bind into lower arguments/adjuncts, and the passive agent in Turkish may not license depictives. Furthermore, control by the passive agent crosslinguistically is quite restricted, being limited to impersonal passives (or passives with inanimate subjects) (see van Urk 2013, Pitteroff and Schäfer 2017 for recent discussion); indeed Lithuanian exhibits this pattern (see Legate et al. 2020). Therefore the claimed crosslinguistic generalization does not hold – the passive agent does not pattern for relationships below its thematic position as syntactically projected in the same way as the active agent. We need a difference between the active and passive even at the thematic position, so that low properties can potentially show sensitivity to this difference. Again, an alternative analysis is needed.

Another class of syntactic analyses of the passive that cannot account for our data are based on the claim that the passive agent is not demoted in any sense, but rather syntactically projected as a (potentially null) argument. Collins 2005 is an influential modern proponent of this approach, although Baker et al. 1989 (building on Jaeggli 1986) can be viewed as a precursor, with the passive morpheme treated as an argument itself, receiving case and the subject θ -role. Much of the argumentation above centers on the demonstration

⁴⁹In the section of the paper discussing syntax, this is illustrated as removing the element entirely, so as to allow A-movement past it. In the section of the paper discussing the semantic interpretation, this is illustrated as leaving an unbound variable, which may then be subject to Existential Closure (Heim 1982). It is not clear how to reconcile these two conceptions.

⁵⁰Neither does Lithuanian, in which depictives obligatorily exhibit agreement in both ϕ -features and case. Turkish depictives in contrast do not agree. See Legate et al. 2020).

that the passive agent in Turkish behaves as syntactically unprojected, in contrast with the Turkish impersonal agent, which behaves as syntactically projected. Baker et al. 1989 discusses Turkish and Lithuanian, claiming that the passive morpheme in these languages can be generated in argument position, either subject or object or both, and then cliticized to INFL, allowing it to appear as a morpheme on the verb. (Although this does not derive the correct morpheme ordering for Turkish, passive between causative and aspect, see (80) above.) They prevent the passive morpheme from being generated only in the object position (yielding the equivalent of an antipassive, see below) through locality. Specifically with the stipulation that the passive morpheme must move to INFL, this movement can only satisfy locality from the subject position, not from the object position; movement of the object requires prior cliticization of the subject, thereby freeing up the subject position for the object to move through.⁵¹ The ability for the passive analysis in Baker et al. 1989 to generate passives of passives is a serious defect of the theory. Collins 2005 differs from Baker et al. 1989 in not positing cliticization, and does not discuss the Turkish (and Lithuanian) data. It is not clear how passives and impersonals are to be differentiated in this theory, so I do not speculate on how it would capture the nonexistence of passives of passives, but the existence of impersonals of passives. For additional arguments against the approach of Collins 2005, see Bowers 2010, chapter 2, and Legate 2014, 64-82, among others.

Finally, I turn to syntactic analyses of the passive in which the passive agent is not syntactically projected, as required for our data. My analysis will be couched in this tradition, following Bruening 2013, Legate 2014, Alexiadou et al. 2015, i.a., and also following that tradition I will adopt the general semantic framework of Heim and Kratzer 1998. A primary benefit of this style of analysis is the intrinsic ordering imposed by the syntactic hierarchy and the compositional semantic interpretation. Specifically, the composition of the verb with its thematic object occurs low in the tree, before introduction of the thematic subject. Therefore, passivization of the thematic subject cannot make the thematic object available for passivization, thereby ruling out a passive of a passive. Consider the following

⁵¹They implement this technically through the version of Government in Baker 1988.

basic tree:⁵²

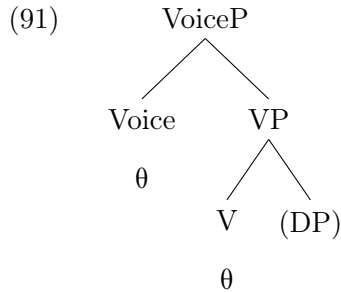

If the thematic object (in parentheses) is present in the structure, then it will be assigned its θ -role by the verb as usual, regardless of whether VoiceP is active or passive. If the thematic object is absent from the structure, a passive of a passive still cannot arise. The thematic object position will be unsaturated, creating difficulty in the semantic composition between the VP and the Voice⁰. Assume for simplicity the approach of Bruening 2013, whereby the existential quantification of the passive thematic subject (Bach 1980, Keenan 1980, Williams 1987, Bruening 2013, Legate 2014, Alexiadou et al. 2015, among many others) enters the derivation on a Pass⁰ above VoiceP. (For ‘initiator’ used as the subject θ -role, see Ramchand 2008, Bruening 2013, ia.) Also assume that Voice⁰ is of type $\langle\langle st \rangle, \langle e, \langle s, t \rangle \rangle\rangle$ and so in the active takes VP, of type $\langle st \rangle$ as its semantic argument.⁵³ For the construction under consideration, a passive in which the thematic object position is left open, the result would be the following.

(92) Jane was cited.

⁵²In this tree, I represent the object θ -role as assigned by the lexical verb, as is standard. If however, the object θ -role is instead assigned by a functional head dominating the VP, our argumentation proceeds unaffected.

⁵³In the semantic denotations, the type of individuals is e , the type of events is s , and the type of truth values is t .

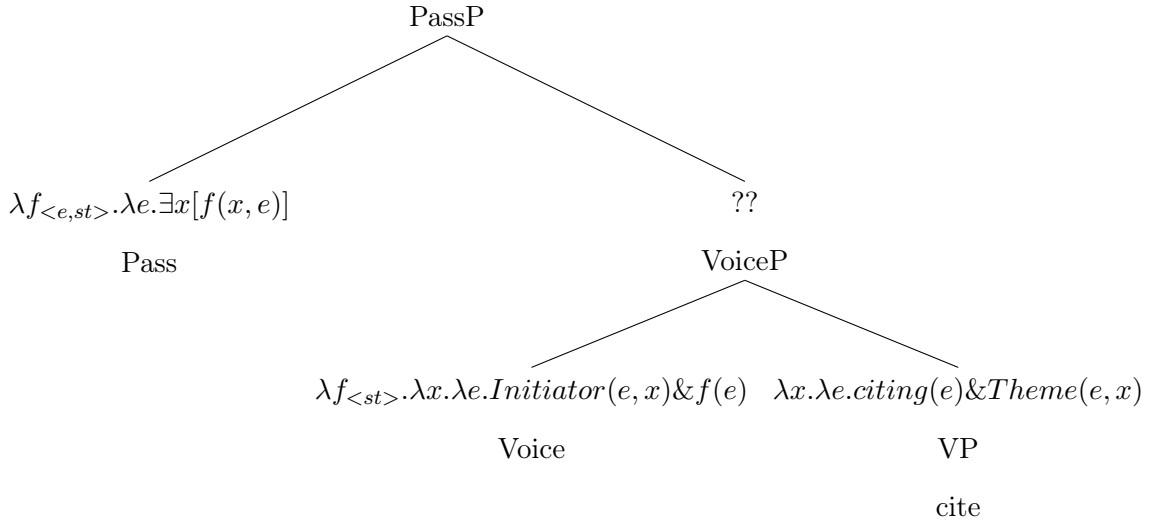

Voice⁰, of type $\langle \langle st \rangle, \langle e, \langle s, t \rangle \rangle \rangle$, and the VP, of type $\langle e, \langle s, t \rangle \rangle$, cannot combine. Kratzer's (1996) alternative approach to the general combination of Voice⁰ and VP also cannot yield a passive of a passive in this structure. On this proposal the Voice head is of type $\langle e, \langle s, t \rangle \rangle$ and combines with the verb phrase, normally of type $\langle s, t \rangle$, through Event Identification.

- (i) Event Identification

If a is of type $\langle e, \langle s, t \rangle \rangle$ and b is of type $\langle s, t \rangle$, $[[a \ b]] = \lambda x . \lambda e . [[a]](e, x) \& [[b]](e)$

Leaving the object unsaturated within the VP on this approach would yield the following.

- (93) Jane was cited.

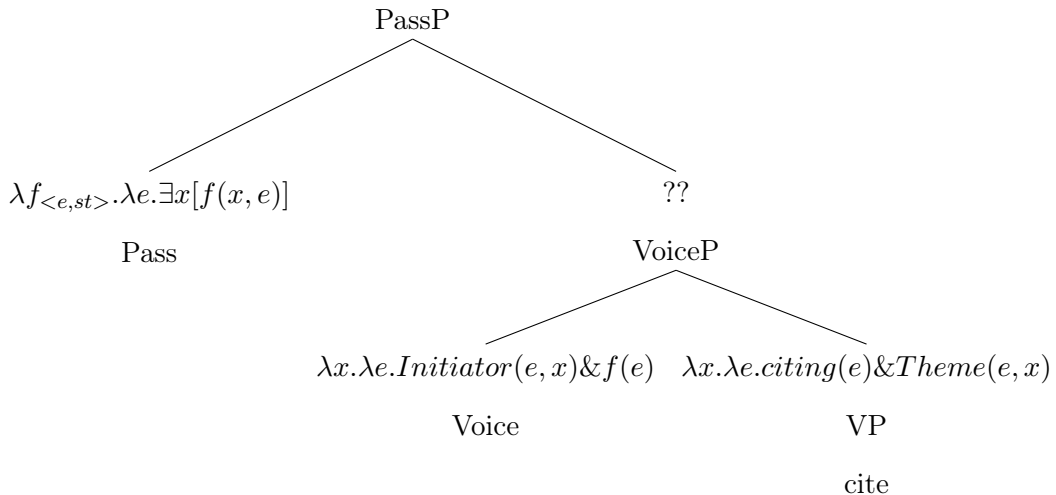

Voice⁰ and VP could combine through Function Composition (Heim and Kratzer 1998). Crucially, this would yield a reflexive interpretation,⁵⁴ but not a passive of a passive.

$$(94) \quad \lambda x.\lambda e. Initiator(e, x) \& citing(e) \& Theme(e, x)$$

Therefore, leaving the object position open within the VP cannot derive a passive of a passive. Positing existential quantification for the thematic object below VoiceP in contrast would yield the correct interpretation. This tree again assumes PassP as the source of existential quantification for simplicity.⁵⁵

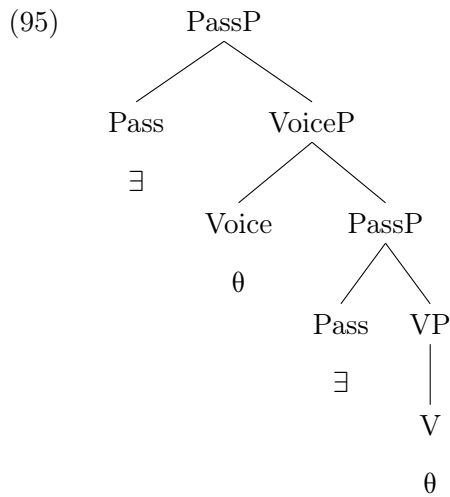

However, this tree structure is not a passive of a passive. Again, the core property of a passive of a passive is that the first instance of the passive demotes the thematic subject, whereby the thematic object becomes the most prominent argument and thus available for demotion on the second instance of the passive (see for example the discussion of Kiparsky 2013 and Murphy 2014 above). In contrast, in (95) the thematic object is demoted by the lower Pass⁰, entirely independently of the demotion of the thematic subject by the higher Pass⁰. It is then perhaps most accurately described as a passive of an antipassive. The distinction is important. If a passive of a passive were possible, it would be expected in a

⁵⁴and indeed would be a possible analysis of reflexive predicates.

⁵⁵This structure seems a natural extension of Bruening 2013, and achieves the correct interpretation in that framework; however, while Bruening 2013, 37-38 mentions passives of passives as support for the analysis of the passive, that work does not provide a syntactic structure, and this structure is not compatible with the claim there that “Voice universally selects for V” (Bruening 2013, 37). (This claim seems untenable given proposals in which Voice selects for other projections, including at least (causative) vP and ApplP.)

language that independently only exhibits a passive. A passive of an antipassive, in contrast, could only occur in a language that exhibits demotion of the thematic object independently, in addition to the passive. I leave aside as orthogonal the potential existence of passives of antipassives.

In sum, a syntactic analysis of the passive whereby the passive is built using different lexical items from the active successfully naturally captures the absence of passives of passives crosslinguistically, whereas an analysis whereby the passive is an operation that changes an active into a passive does not. To my knowledge, this is a novel argument against a rule-based analysis of the passive, be it a lexical or syntactic rule.

Let us develop such a syntactic analysis of the passive in more detail. I continue to assume that the θ -role for the thematic subject is present in the structure of a passive, on Voice⁰, but that this θ -role is not assigned to a DP. In the absence of a ‘by’-phrase, the thematic subject position is existentially quantified (Bach 1980, Keenan 1980, Williams 1987, Bruening 2013, Legate 2014, Alexiadou et al. 2015, among many others). As mentioned, Bruening 2013, as well as Alexiadou et al. 2015 for English, places this existential quantification on a functional projection dominating VoiceP. I do not adopt this approach because of difficulties that arise for passives with ‘by’-phrases. When the passive occurs with a ‘by’-phrase, the ‘by’-phrase closes the thematic subject position, rendering the Pass⁰ semantically vacuous. To make this Pass⁰ nevertheless compatible with standard Minimalist theory, which claims that all elements that survive to the interfaces must receive an interpretation (Full Interpretation, Chomsky 1986), Bruening 2013 treats this Pass⁰ as an identity function. This is technically adequate, if unsatisfying. It also means that PassP must be forced to appear when semantically vacuous, to ensure uniform passive morphology; Bruening 2013 develops a system of featurally-based syntactic selection for this purpose. Voice⁰ syntactically selects for a nominal specifier, but does not combine with a nominal specifier in the passive. This should result in ungrammaticality, however, it is proposed that Pass⁰ can itself select for a VoiceP with an unsatisfied selectional feature, and that this avoids the ungrammaticality. This proposal thus seems to make use of a forced notion of selection.

Instead, I analyze the passive as a subtype of the Voice head itself, and place the existential quantification there. (For closely related approaches see Chomsky 2000, Legate 2014, and Alexiadou et al. 2015 for Greek.⁵⁶) Syntactically, the Voice_{PASS} head introduces the external θ -role, but does not syntactically project this argument into its specifier. It is therefore compatible with a ‘by’-phrase adjunct, which optionally adjoins to VoiceP to specify the thematic subject. I indicate the difference in specifier selection between active and passive voice featurally, again using [\bullet D \bullet] to indicate selection of a DP specifier (Müller 2010).

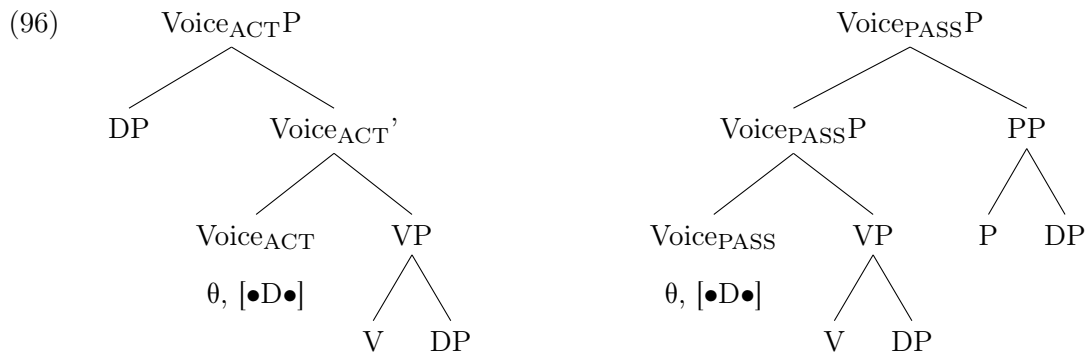

Semantically, the passive needs to allow the external θ -role to be satisfied by the ‘by’-phrase, when present, and to otherwise be interpreted existentially. I therefore propose that Voice_{PASS} has two associated semantic denotations. The first, which does not combine with a ‘by’-phrase, is illustrated in the derivation below. Irrelevant details are omitted. Notice that the initiator is existentially bound on the Voice_{PASS} head itself.

(97) Jane was cited.

⁵⁶Alexiadou et al. 2015 analyse the Greek passive as structurally different from the English on the grounds that the Greek is unproductive, while the English is productive. An alternative is that the difference in productivity is due to learning, not syntactic structure; see Yang 2016 for a learning approach to productivity.

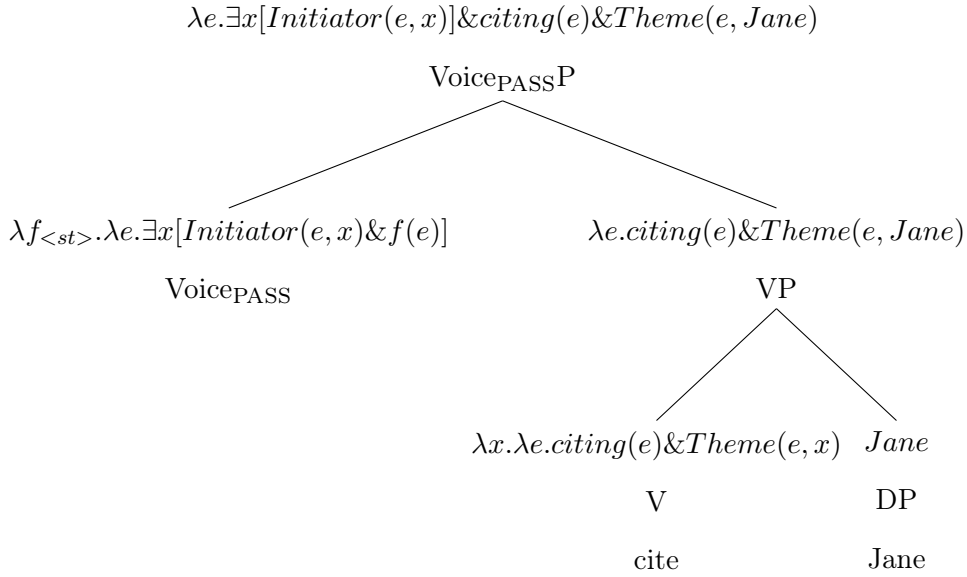

The second semantic denotation of Voice_{PASS} leaves the initiator position open to be accessed by the ‘by’-phrase (see Bruening 2013 for this denotation of the ‘by’-phrase) (‘Theme’ abbreviated to ‘TH’ and ‘Initiator’ to ‘Init’ for space reasons).

(98) Jane was cited by Al.

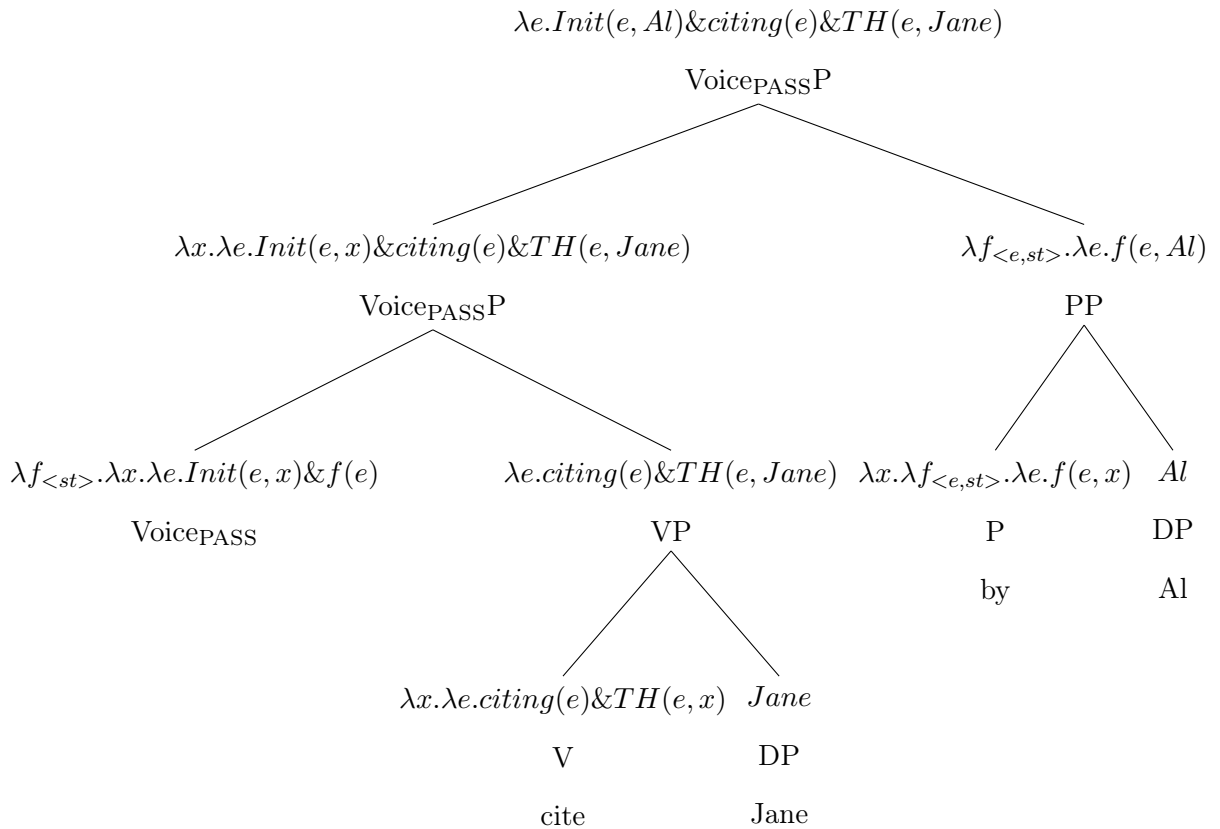

It is important to note that we do not expect the morphological realization of the passive to be sensitive to the two semantic denotations of $\text{Voice}_{\text{PASS}}$. I adopt a Y-model of grammar with a post-syntactic morphology, following Halle and Marantz 1993, Chomsky 2000, and much following literature. The syntactic derivation bifurcates into the PF branch, which determines the pronunciation and is fed the syntactic structure and the morphosyntactic features of the heads, and the LF branch, which determines the interpretation and is fed the syntactic structure and the semantic properties of the heads. The morphological realization of the elements that make up the tree is determined in the morphological component, located on the PF branch. On this approach, the morphological realization of $\text{Voice}_{\text{PASS}}$ is determined based only on the morphosyntactic features, semantic denotations being unavailable on the PF branch. Since the morphosyntactic features of $\text{Voice}_{\text{PASS}}$ are uniform, including the external θ -role but no $[\bullet\text{D}\bullet]$ feature to select a DP specifier, the realization of $\text{Voice}_{\text{PASS}}$ is also uniform, regardless of the presence/absence of the ‘by’-phrase.⁵⁷

This is the core syntax and semantics of the passive in contrast with the active. Other properties are language-specific, superimposed on this basic structural difference – the (non)availability of passives of unergatives and of pseudopassivization, the presence/absence of object promotion to the grammatical subject position, and so on (for recent related discussion, see Bruening 2013, Legate 2014, Alexiadou et al. 2015, *inter alia*).

To summarize, I have argued that the absence of passives crosslinguistically supports an analysis of the passive that involves not a passivization rule, be it lexical or syntactic, but rather alternative syntactic structure building. Such a syntactic analysis benefits from the intrinsic ordering imposed by the syntactic tree and its compositional interpretation, whereby the relationship between the verb and its thematic object is determined lower than and prior to introduction of the thematic subject. Demotion of the thematic object, then, must be accomplished independently from demotion of the thematic subject (as for example in an antipassive). A passive of a passive, in which demotion of the the-

⁵⁷There is much related work; see for example Embick 2004 for example, which argues that the nonactive morphology in Greek is sensitive only to the lack of a DP specifier, and so encompasses unaccusatives, passives, and related constructions, and Kallulli 2007.

matic object is dependent on prior demotion of the thematic subject, is precluded. Further, I have developed a specific instantiation of this type of analysis, proposing that passive is a subtype of Voice⁰, the syntactic head that introduces the thematic subject. The passive Voice head does not select for a specifier to assign the subject θ -role to, but rather either existentially quantifies over the thematic subject position, or leaves it open to be accessed by a ‘by’-phrase adjunct.⁵⁸

2.2 Impersonals in Negation-Licensed Commands

In this part of the chapter I briefly investigate the status of the null argument in another construction Iatridou (accepted) dubs ‘Negation-Licensed Commands’ (NLCs).

In English, NLCs are characterized by the use of a gerund in combination with a special negative marker, as illustrated in (99). Iatridou (accepted) shows that these commands survive as commands only when they are negated, and that crosslinguistically the absence of negation leads to a completely different (i.e. non-command) meaning, or to ungrammaticality, (100).⁵⁹

- (99) a. No reading the newspaper in class!
 b. No walking on the grass! (Iatridou accepted:2)
- (100) a. *Reading the newspaper outside of class!
 b. *Staying off the grass! (Iatridou accepted:3)

Focusing on NLCs from Turkish, Sason Arabic (SA) and English, I argue that in NLCs as well, an unpronounced impersonal pronoun in the form of PRO_{ARB} can fill the argument position,⁶⁰ (contra Pak et al. 2020, who mainly focus on different notions of addressee, but

⁵⁸For a potential extension of the analysis to ‘passives of unaccusatives’, see Legate et al. 2020.

⁵⁹Iatridou (accepted) argues that this gerund constitutes a distinct type of gerund, since it can assign case to its object, it takes adverbs, and yet it can take the determiner *no* – though, crucially, no other determiner. As such, she calls it ‘no-gerund’.

⁶⁰Iatridou (accepted, 12) in fact makes the same suggestion on the basis of binding for English NLCs. NLCs allow binding of reciprocal whereas imperatives do not.

- (i) a. No washing oneself in public!
 b. *Don’t wash oneself in public. (Iatridou accepted:12i-ii)

also discuss NLCs, which they suggest do not syntactically project the subject).

Iatridou (accepted) demonstrates that NLCs appear in many unrelated languages (with some morphosyntactic variation), including Turkish. In Turkish, NLCs are realized in the form of an obligatory, negated existential copula *yok* “there isn’t” on a nominalized clause, as in (101).

- (101) a. Geç saat-te TV izle-mek yok!
 late hour-LOC TV watch-NMLZ YOK
 ‘No watching TV at night!’
 Lit: ‘There isn’t watching TV late at night!’ (Iatridou accepted:67a)
- b. Yüksek ses-le konuş-mak yok!
 loud sound-with talk-NMLZ YOK
 ‘No talking loudly!’
 Lit: ‘There isn’t talking loudly!’

(102) illustrates the common use of the negated existential copula. As also mentioned in Iatridou (accepted), there is nothing modal in this sentence, as such it does not mean that bread is forbidden in the house.

- (102) Ev-de ekmek yok.
 house-LOC bread YOK
 ‘There isn’t bread in the house.’

NLCs in Sason Arabic are constructed in a similar manner: a gerund in combination with a negated existential copula *ma-fi* “there isn’t”.

- (103) a. xasıl potad fi sake ma-fi!
 wash.GRND clothes in lake NEG-exist
 ‘No washing clothes in the lake!’
 Lit: ‘There isn’t washing clothes in the lake!’
- b. şarb tattun fi sayyara ma-fi!
 smoke.GRND tobacco in car NEG-exist
 ‘No smoking tobacco in the car!’
 Lit: ‘There isn’t smoking tobacco in the car!’

For also further discussion of the difference between NLCs and imperatives, see Iatridou accepted.

The common use of the negated existential predicate is illustrated in (104).

- (104) axpeys ma-fi fi bayt!
bread NEG-exist in house
'There isn't bread in the house.'

I argue that in all three languages, Turkish, SA and English, a null [impersonal] pronoun *can* be projected in the argument position, which is essentially identical to the 'arbitrary' understanding of PRO' (following the discussion by McCloskey (2007)).⁶¹ In order to do so, I use some of the diagnostics from the earlier discussion of impersonals in Turkish.

The reciprocal binding requires a projected binder in these languages (see Chapter 3 which establishes this and other tests for SA). Crucially, reciprocal binding is licit in NLCs.

(105) Turkish

- a. Birbiri-yle konuř-mak falan yok.
each.other-with talk.NMLZ or so YOK
'No talking or anything with each other!'
- b. Bu çizgi-nin öte-si-nde birbiri-ne tek kelime et-mek yok!
this line-GEN beyond-POSS-LOC each.other-DAT one word do-NMLZ YOK
'No uttering a word to each another (one another) beyond this line!'

(106) Sason Arabic

- a. nihane şıxle wara bazken ma-fi.
here talk.GRND with each.other NEG-exist
'No talking with each other here!'
- b. nazf roken ma-fi fi sake!
clean.GRND yourselves NEG-exist in lake
'No cleaning yourselves in the lake!'

(107) English

⁶¹I phrase it as 'can' rather than 'is' since NLCs can also be used when there is a specific addressee as well, as shown in (i). I leave their discussion aside.

- (i) [a parent to their child(ren):]
a. No swimming in your shorts!
b. No eating ice cream before dinner!

- a. No throwing oneself/yourself on the ground! (in a hockey field)
- b. No cleaning oneself/yourself in the public bathroom!

Secondly, depictives, which also require a projected binder, are licensed in the NLCs.⁶²

(108) Turkish

- a. Alkollü araba kullan-mak yok tamam mı!
 drunk car drive-NMLZ YOK ok Q
 ‘No driving a car drunk, understood!’
- b. Bu plaj-da çıplak yüz-mek filan yok!
 this beach-LOC naked swim-NMLZ or so YOK
 ‘No swimming naked or anything like that in this beach!’

(109) Sason Arabic

- a. amıl araba sarxoş ma-fi!
 drive.GRND car drunk NEG-exist
 ‘No driving the car drunk.’
- b. lope futbol cuan ma-fi!
 play.GRND football hungry NEG-exist
 ‘No playing football hungry.’

(110) English

- a. No swimming naked in these waters!
- b. No dancing around drunk!

Furthermore, the null impersonal in NLCs can act as a controller.

- (111) [PRO Otobüs-e yetiş-mek için] IMP koş-mak yok!
 bus-DAT catch-NMLZ for run-NMLZ YOK
 ‘No running to catch the bus.’

In addition to the active version in which there is a projected external argument, NLCs also allow a passive nominalization in which the implicit agent may be existentially interpreted.

⁶²Noting again that there is some debate on the licensing of depictives by the thematic subject of English passives; e.g. Roeper 1987 and Landau 2010.

(112) English

- a. No being spotted in these kinds of missions (by the enemy)!
- b. No being perceived as weak in front of a bully!

(113) Turkish

Bu kadar gizli görev-ler-de düşman tarafından tespit ed-il-mek yok!
this much secret mission-PL-LOC enemy by spot do-PASS-NMLZ YOK

‘No being spotted in these kinds of secret missions (by the enemy)!’

NLCs also require an addressee that can understand the command, act upon it (both in generic and specific addressee contexts); due to this nature of NLCs, the most salient interpretation involves a humanness condition, and indeed it is very hard to differentiate the two from each other. I will assume that a humanness condition is at play.⁶³

(114) Turkish

a. #Dağ-lar-da ulu-mak yok!
mountain-PL-LOC howl-NMLZ YOK

‘No howling in the mountains!’

b. Çayır-lar-da koş-mak yok!
field-PL-LOC run-NMLZ YOK

‘No running in the fields.’(for people, not animals/creatures)

NLCs involve a thematic Voice projection since they are compatible with agent-oriented adverbs, (115a), and instrumentals, (115b). In addition, the object is assigned Case.

(115) Turkish

a. Kendi-ni kasten yer-e at-mak yok!
self-ACC intentionally ground-DAT throw-NMLZ YOK

‘No throwing yourself on the ground intentionally!’

b. Duvar-ı çivi-yle del-mek yok!
wall-ACC nail-with make.a.hole-NMLZ YOK

‘No making a hole in the wall with a nail!’

⁶³Note that it is possible to utter the sentence ‘No breaking down on me’ to an oven prior to hosting a party, but this sounds like an instance of anthropomorphization.

(116) Sason Arabic

- a. var bılqasti fi tırap ma-fi!
fall.GRND intentionally in ground NEG-exist
'No falling on the ground intentionally!'
- b. xasil potad wara sope ma-fi!
wash.GRND clothes with stick NEG-exist
'No washing clothes with a stick!'

On the other hand, this construction lacks higher projections such as aspect. Note that in Turkish, the nominalizer *-mAk* cannot directly attach to the progressive morpheme *-(I)yor*, but a copula is inserted onto which it leans. I take this to mean that the verb can raise higher in the clause, presumably T in Turkish, and attach to *-mAk*, but only up to Asp in the presence of an aspectual morpheme. In that case, the copula *ol-* is inserted.

(117) Turkish

- a. İş baş-ı-nda uyu-mak yok!
work head-CM-LOC sleep-NMLZ YOK
'No sleeping on the clock!'
- b. *İş baş-ı-nda uyu-yor ol-mak yok!
work head-CM-LOC sleep-PROG be-NMLZ YOK
'No being sleeping on the clock!'

Moreover, NLCs lack the ImpersP, which can be illustrated on the basis of Turkish. As discussed in section 2.1.5, Turkish impersonals are realized with the impersonal morpheme on the predicate that is homophonous to the passive morpheme, as in (118a). However, when these impersonals are used in NLCs, the impersonal morpheme is ruled out, as shown in (118b).

(118) Turkish

- a. İş baş-ı-nda uyu-n-ur!
work head-CM-LOC sleep-PASS-AOR
'People sleep on the clock!'

- b. *İş baş-ı-nda uyu-n-mak yok!
 work head-CM-LOC sleep-PASS-NMLZ YOK
 ‘No sleeping on the clock!’

Therefore, I suggest the structure in (119) for NLCs, which are essentially nominalizations that become commands in the presence of negation, despite crosslinguistic variation in the morphosyntactic expressions of the NLCs. Given that Impers^0 is absent in NLCs, which otherwise licenses the IMP pronoun, (cf. (118a)), I assume that it is the combination of a nominalization under negation that licenses this head (note that neither head is sufficient on its own for the NLC reading), though I simply place it on Neg^0 . Various implementations of this intuition are conceivable; for the sake of exposition, I assume that Neg^0 and Nmlz^0 heads manifest agreement, as well as Neg having the uninterpretable valued ϕ -feature. This features initiates the Agree operation; it probes down the tree and finds the impersonal pronoun, whereupon Neg^0 values the ϕ -feature of the impersonal pronoun, the impersonal pronoun checks the uninterpretable feature of Neg^0 , marking it for deletion from the LF branch.⁶⁴

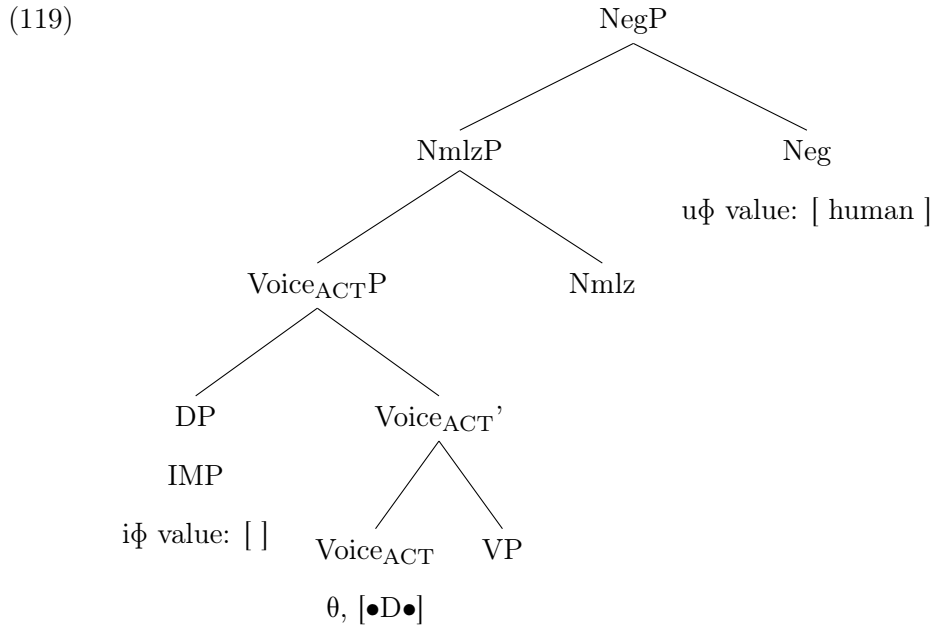

⁶⁴Again leaving aside various significant issues to be resolved for this construction.

2.3 Overt impersonal in Turkish

Turkish has an overt impersonal *insan* ‘human’, which can function as an impersonal pronoun, similar to those found in many languages, such as English *one* or German *man*. In this section, I examine the behavior of *insan* from distributional and interpretational perspectives, and demonstrate that it is not an overt realization of the null impersonal pronoun considered earlier, but rather patterns differently.

Fenger (2018) examines the dedicated impersonal pronouns in Germanic languages, and sketches an analysis focusing on the similarities and differences between English and Dutch-type impersonal pronouns, suggesting that the former (which she calls imp- ϕ) has more functional structure than the latter type (imp-N). She provides data from ECM constructions and sentences where the pronoun is a derived subject (e.g. passive and unaccusative sentences) to show that the syntactic distribution of imp-N pronouns cannot solely follow from (im)possible underlying positions (as proposed by Cinque 1988, Egerland 2003, a.o.), but that the restriction has to do with the surface, i.e., derived position.

In this section, I demonstrate that null impersonal in Turkish patterns like Dutch-type impersonal pronouns, whereas the overt impersonal *insan* behaves similar to English type-pronouns. In doing so, I investigate these impersonals in terms of their syntactic positions, cases they can bear, and interpretational restrictions they exhibit. The results reveal that although Fenger (2018) shows that the empirical picture is more complex than has been noted in the literature (e.g. Cinque 1988; Egerland 2003), even that study does not capture all the facts. The empirical picture is more complicated, in that the null impersonal in Turkish does not neatly fall into the split Fenger (2018) makes.

2.3.1 Properties of the overt impersonal

Fenger (2018) investigates overt impersonal pronouns in eight Germanic languages, and on the basis of a number of properties, suggests a division between two types of dedicated impersonal pronouns. She uses imp- ϕ and imp-N to refer to the two types of impersonal

pronouns, based on their structural make-up. For instance, the impersonal in English, Frisian, Icelandic is categorized as *imp- ϕ* ; whereas German, Norwegian, Danish, Swedish and Dutch impersonals fall into the category of *imp-N*. The list of properties Fenger discusses is given in Table 2.2.

Properties	<i>imp-ϕ</i>	<i>imp-N</i>	
	e/fri/i	g/da/n	s/du
(i) verbal agreement	3sg	3sg	3sg
(ii) generic inclusive reading	✓	✓	✓
(iib) existential reading, subject	*	✓	✓
(iic) existential reading, derived subject	*	*	✓
(iii) object position	✓	*	*
(iv) ECM	✓	*	*

Table 2.2: Properties of impersonal pronouns (v1)
(Fenger, 2018, 4)

For the sake of the discussion, I adopt the distinction Fenger (2018) proposes for the overt impersonal pronouns, and apply the diagnostics to the overt impersonal *insan* in comparison with the null impersonal in Turkish.⁶⁵

2.3.1.1 The data and diagnostics

Both pronoun types have third singular person verbal agreement, as shown in (120) for English, an *imp- ϕ* language, and for Dutch, an *imp-N* language.

- (120) a. In dit land geef-**t men elkaar** cadeautjes met kerst.
 In this country give-s IMP each.other presents with christmas
 b. In this country, **one** give-s **each other** presents at Christmas.

(Fenger, 2018, (3))

The verb bears the third person agreement *-t* in Dutch, (120a), and *-s* in English, (120b). Note that in both languages the impersonal pronoun behaves as semantically plural, thus license reciprocals.

⁶⁵Though in section 2.3.2, I demonstrate that the structures associated with the terms *imp- ϕ* and *imp-N* need to be modified given the data introduced in this section.

Turning to Turkish, the overt impersonal *insan* is identical to other languages in requiring 3rd person singular agreement on the verb, as shown in (121) (I gloss *insan* ‘human’ as *one* or *people* throughout for expository purposes).

- (121) İnsan [çalış-ır-ken] müzik dinle-r-(*ler).
 one [study-AOR-when] music listen-AOR-(*PL)
 ‘One_i listens to music when one_i studies.’
- (122) İnsan kışın tatil-e git-me-z.
 one winter holiday-DAT go-NEG-AOR
 ‘One doesn’t go for a vacation in winter.’ (Turan 1996:140, (32))

Similarly, *insan* can bind the reciprocal when pragmatic factors, such as saliency, are controlled for. Several examples follow.⁶⁶

- (123) a. Bu sebep-le insan birbirin-e âfiyet temenni et-meli-dir-(*ler).
 this reason-with people each.other-DAT health wish do-OBLG-GM-PL
 ‘For this reason, people should wish health to one another.’ (google search)
- b. İnsan birbirin-e bun-u nasıl yap-ar ya!
 people each.other-DAT this-ACC how do-AOR EXCL
 ‘How can people do this to each other?’
- c. Ne ayıp! İnsan birbiri-nden selam-ı esirge-r mi?
 what shame people each.other-ABL greeting-ACC deny-AOR Q
 ‘What a shame! How could people deny one another a greeting?’ (*Kaplan Köşesinden*, a book, p. 93)
- d. Nevin Gökçek “İnsan birbiri-ni sev-meli aynı zamanda saygı
 Nevin Gökçek people each.other-ACC love-OBLG same time respect
 göster-meli ...” ifade-ler-i-ni kullan-dı.
 show-OBLG ... statement-PL-POSS-ACC use-PST
 ‘Nevin Gökçek said “People should love and at the same time show respect to

⁶⁶This qualification is significant since Yazar (2016) judges (i) as ungrammatical (I changed the translation of *kutla-* from ‘greet’ to ‘congratulate’).

- (i) *İnsan birbiri-ni kutla-r.
 one each.other-ACC congratulate-AOR
 ‘One congratulated each other.’ (Yazar, 2016, (6))

The example in (i) was translated as in the past tense. When this is controlled for and a salient context is provided, it improves significantly.

each other ...’⁶⁷

This property is also observed with group names, which license a reciprocal both in German, (124a) and in Turkish, (124b).

- (124) a. Das Team hat einander nicht mehr vertraut.
the team has each.other not more trusted
‘The team didn’t trust each other anymore.’ (Wurmbrand, 2016, (12c))
- b. Takım birbiri-ne hiç ısın-a-ma-dı.
team each.other-DAT at.all warm.up-ABIL-NEG-PST
‘The team couldn’t warm up to one another.’

In this respect, *insan* patterns like the null impersonal, discussed in §2.1, which can also bind the reciprocal. The structures in (125) must be impersonal, since neither has a structurally case marked object in the active.⁶⁸

⁶⁷<https://www.eliftecer.com/?gn=mk&ID=572&b=yarim-asirlik-ciftlere-sevgililer-gunu-kutlamasi>
Accessed on February 20, 2021.

⁶⁸The contrast between reciprocal binding and verbal agreement is telling: Whereas semantic plurality seems to be enough for anaphor binding, syntactic plurality is needed for the verbal agreement. The following piece of data is in line with this generalization. In Turkish numerals normally cannot be combined with plural nouns, and therefore cannot trigger plural agreement on the verb, while they can bind anaphors. Consider (i).

- (i) Yedi cüce birbirlerin-i teselli et-ti-(*ler).
seven dwarf each.other-ACC console do-PST-PL
‘(The) seven dwarves consoled each other.’

This can be contrasted with instances in which numerals can be combined with plural nouns, when the entity denoted by the noun is a closed ‘well known’ group (Göksel and Kerslake 2005:148) or a proper name (Arslan-Kechriotis 2006: fn. 47).

- (ii) a. Yedi Cüce-ler
seven dwarf-PL
‘The Seven Dwarfs’
Üç Silahşör-ler
three musketeer-PL
‘The Three Musketeers’

As first noted by Özyıldız (2017), plural marking on the noun licenses plural agreement on the predicate.

- (iii) Yedi cüce-ler şaç-ı-ndan tarağ-ı al-mış-lar.
seven dwarf-PL each.other-ACC console do-PST-PL
‘The Seven Dwarfs consoled each other.’ (Özyıldız 2017:19)

- (125) a. Herkes-in gör-eceğ-i şekil-de birbiri-ne gir-il-ir mi?
 everyone-GEN see-NMLZ-ACC manner-LOC each.other-DAT enter-PASS-AOR Q
 ‘Why would people fight tooth and nail in a way everyone could see?’⁶⁹
- b. Buralarda bayram-lar-da birbiri-ne pilav pişir-il-ir.
 here holiday-PL-LOC each.other-DAT pilaf cook-PASS-AOR
 ‘Around here, during holidays, people pilaf-cook for each other.’

Properties	T-<i>insan</i>	T-<i>null</i>
(i) verbal agreement	3sg	3sg
(ii) reciprocal binding	✓	✓

Table 2.3: Verbal agreement and reciprocal in Turkish

Secondly, Fenger (2018) shows that both pronoun types can occur in subject position. Regarding the possible readings in subject position, the two readings are (inclusive) generic reading and existential reading. In Germanic languages, both pronouns have the inclusive generic reading, as shown in (126).

- (126) Intended: ‘When **people** are in Italy, they have the habit of eating pasta’
- a. When **one** is in Italy, one eats pasta.
- b. Wanneer **men** in Italie is, eet men pasta.
 When IMP in Italy is, eat IMP pasta. (Dutch; Fenger, 2018, (4))

In Turkish, both pronouns are compatible with a generic reading, and can occur in subject position, (127). Following the discussion in section 2.1, I represent the null pronoun in the case of null impersonals with IMP.

- (127) a. **İnsan** çalış-ır-ken müzik dinle-r.
 one study-AOR-when music listen-AOR
 ‘One listens to music when one studies.’
- b. Burada her gece IMP dans ed-il-ir .
 here every night dance do-PASS-AOR
 ‘People dance here every night.’

⁶⁹Retrieved October 30, 2019 from <https://www.haber61.net/trabzonspor/sosyal-medyada-trabzonspor-yonetmeleri-birbirine-girdi-h298270.html>

As discussed in Moltmann (2006) (cited in Fenger 2018), the impersonal pronoun has a bound variable interpretation, in that all instances of the impersonal pronoun in the same sentence refer to the same x , in Germanic languages as well as Turkish. This is a general property of quasi-universal pronouns, such as arbitrary *pro*, PRO, Italian *si*, Finnish *gi* (D'Alessandro 2007; Holmberg 2010; Moltmann 2006). In Turkish, given its *pro-drop* property, the subject of the subordinate clause must be null when coindexed with the matrix subject, as in (128a). The overt subject in a subordinate clause is necessarily disjoint in reference with the higher subject, as illustrated in (128b) (Kornfilt 1991b; Erguvanlı-Taylan 1986).

- (128) a. Orhan_{*i*} [*pro*_{*i*} çalış-ır-ken] müzik dinle-r.
 Orhan [study-AOR-when] music listen-AOR
 ‘Orhan_{*i*} listens to music when he_{*i*} studies.’
- b. Orhan_{*i*} [*o*_{**i/j*} çalış-ır-ken] müzik dinle-r.
 Orhan [he study-AOR-when] music listen-AOR
 ‘Orhan_{*i*} listens to music when he_{**i/j*} studies.’ (Turan, 1996, 8)

Turning to the impersonal *insan*, (129a) demonstrates that it is not possible to repeat it as the subject of the subordinate clause. (129b) indicates the impersonal cannot control a pronoun in the embedded clause, either. Therefore, it seems that the impersonal pronoun has a bound variable reading, although some instances of it must be null.

- (129) a. **İnsan** [(***insan**) çalış-ır-ken] müzik dinle-r.
 one [(***one**) study-AOR-when] music listen-AOR
 ‘One listens to music when one studies.’
- b. **İnsan**_{*i*} [*o*_{**i/*j*} çalış-ır-ken] müzik dinle-r.
 one [s/he study-AOR-when] music listen-AOR
 ‘One_{*i*} listens to music when s/he_{**i/*j*} studies.’

As noted in (41), repeated here as (130), for the null impersonal in Turkish, the embedded impersonal agent may be controlled by the matrix impersonal agent (supporting the analysis of both as syntactically projected).

- (130) a. IMP_{*i*} [PRO_{*i*} otobüs-e bin-il-mek] iste-n-di.
 [PRO bus-DAT board-PASS-INF] want-PASS-PST
 ‘One wanted to board the bus.’

- b. IMP_{*i*} [PRO_{*i*} dans ed-il-me]-ye alıř-ıl-dı.
 [PRO dance do-PASS-INF]-DAT get.used.to-PASS-PST
 ‘One got used to dancing.’
- c. IMP [PRO yarın ayrıl-in-mak] iste-n-di, ama yarın için
 [PRO tomorrow leave-PASS-INF] want-PASS-PST but tomorrow for
 hava tahmini çok kötü.
 weather forecast much bad
 ‘One wanted to leave tomorrow, but the weather forecast for tomorrow is too bad.’

In (130), again all instances of the impersonal pronoun must refer to the same x - e.g. for (130a) it means: ‘For any GEN x , it is the same x that boards the bus and wants to board the bus.’ It cannot mean: ‘For some arbitrary choice of x that boards the bus, then there is some arbitrary choice of y , such that y wants that x boards the bus.’ This restriction rules out a possible interpretation of the sentence such as ‘There was wanting for there to be boarding of the bus’ where the identity of the external arguments are left open.

However, it turns out in certain configurations the bound variable reading or joint reference requirement can be overridden. One such instance is when the matrix subject is the overt impersonal, whereas the subordinate clause has the null impersonal, as shown in (131). It is possible to utter (131) in a scenario in which x is among the group of people dancing, indicated via the diacritic i_+ as well as in cases where x is not part of the dancers. The availability of both interpretations is corroborated with the possibility of the conditional clause.

- (131) **İnsan**_{*i*} [IMP_{*i+/j*} dans ed-il-ir-ken] (dans et-mi-yor-sa) sohbet
 one [dans do-PASS-AOR-when] (dance do-NEG-PROG-COND) chat
 et-meli.
 do-SHOULD
 ‘One should chat when it is danced (if one is not dancing).’

The conditional clause leads to a contradiction in cases where the matrix overt impersonal *insan* controls the impersonal of the same type, as in (132). Expectedly, the disjoint reference is out, indicated via $*j$. It must be the same x that dances and chats.

- (132) $\dot{I}nsan_i$ [$PRO_{i/*j}$ dans ed-er-ken] (*dans et-mi-yor-sa) sohbet
 one [dans do-AOR-when] (*dance do-NEG-PROG-COND) chat
 et-meli.
 do-SHOULD
 ‘One should chat when one dances (*if one is not dancing).’

Note that the reverse is infelicitous, in that when the subordinate clause has *insan* as its subject, whereas the matrix clause has the null impersonal, the salient reading is the personal interpretation of *insan*, e.g. it is the proper name of a certain individual. Consider (133).

- (133) [$\dot{I}nsan$ mutlu-yken] IMP dans ed-il-ir.
 [one happy-when] dance do-PASS-AOR
 ‘When Human is happy, it is danced.’

With respect to the existential readings, Fenger (2018) points to a split between $imp-\phi$ and $imp-N$ languages. The examples are as follows.

- (134) Intended: ‘**Someone** has called for you, but I don’t know what it was about’
 a. ***One** has called for you, but I don’t know what it was about.
 b. **Men** heeft voor je gebeld, maar ik weet niet waar het over ging.
 IMP has for you called, but I know not what it about went.
 (Dutch; Fenger, 2018, (5))

Example (134) shows that in languages like English, it is not possible to use the impersonal pronoun to express the existential reading, whereas Dutch-type languages also allow the existential reading. Therefore, Fenger (2018) draws the conclusion that $imp-\phi$ allows only one reading, whereas $imp-N$ allows multiple reading.

Applying this test to Turkish, we see that the overt impersonal patterns like English, whereas the null impersonal like Dutch. This is illustrated in (135).

- (135) a. ***İnsan** san-a bağır-dı, ama ne hakkında-ydı bil-mi-yor-um.
 one you-DAT shout.at-PAST but what about-PAST know-NEG-PROG-1SG
 ‘One has yelled at you, but I don’t know what it was about.’
 b. IMP san-a bağır-ıl-dı, ama kim-in bağır-dığ-ı-nı
 you-DAT shout.at-PASS-PAST but who-GEN shout.at-NMLZ-POSS-ACC

bil-mi-yor-um.
 know-NEG-PROG-1SG
 ‘One yelled at you, but I don’t know who yelled at you.’

The overt impersonal *insan* can be used in the past with an iterative/habitual aspect. Contrast (136a) with (136b), which has an episodic interpretation, thus is ungrammatical.

- (136) a. Tarih boyunca insan insan-ı hep öldür-dü.
 history throughout one one-ACC always kill-PST
 ‘Throughout history people killed people.’⁷⁰
- b. *Dün insan insan-ı / kurd-u öldür-dü.
 yesterday one one-ACC / wolf-ACC kill-PST
 ‘Yesterday people killed people/the wolf.’

Another difference between the two pronoun types is the different syntactic positions. Whereas *imp-ϕ* can occur in the object position, *imp-N* cannot as a surface object, as in (137).

- (137) a. This reminds **one** of the war.
- b. *Dir herinnert **men** aan de oorlog.
 this reminds IMP of the war

(Dutch; Fenger, 2018, (6))⁷¹

Turkish impersonals also behave differently with respect to the possibility of occurring in the surface object position. Whereas the overt impersonal is grammatical, (138a) (also see (136a)), the null impersonal is ruled out, as in (138b), in which the impersonal is intended to refer to human objects, and the verb carries the impersonal morpheme.

- (138) a. Gelişme-ler **insan**-a darbe zaman-lar-ı-nı anımsat-ıyor.
 development-PL one-DAT coup time-PL-CM-ACC remind-PROG
 ‘The developments remind one of the coup times.’
- b. *Ben her zaman IMP sohbet ed-il-ir.
 I every time chat do-PASS-AOR
Intended: ‘I always chat with people_{arb}.’

⁷⁰<https://www.posta.com.tr/yazarlar/yazgulu-aldogan/tarih-boyunca-insan-insani-hep-oldurdu-177336>

⁷¹Fenger (2018) also notes that *imp-N* languages, which do not allow the impersonal pronoun in the surface object position, have a separate pronoun that can occur in that position, e.g. *ein* of German. I discuss them in Section 2.3.2.

Therefore, the results thus far can be summarized in Table 2.4.

Properties	T-<i>insan</i>	T-<i>null</i>
(i) verbal agreement	3sg	3sg
(ii) reciprocal binding	✓	✓
(iii) generic inclusive reading	✓	✓
(iiib) existential reading	*	✓
(iv) object position	✓	*

Table 2.4: Impersonals in Turkish

Let us now take a more in-depth look at the status of subject, whether it is an underlying or derived subject and its correlation with the possible readings. Cinque (1988) and Egerland (2003) have argued that when the imp-N pronoun is the subject of a passive or unaccusative, it can only have a generic, but not an existential reading. The generic reading is given in (139).

- (139) Intended: ‘**People** are being forced to work until the age of 65 (by the government)’
- a. **One** is forced to work until the age of 65.
 - b. **Men** wordt gedwongen te werken tot het 65 levensjaar.
 IMP gets forced to work until the 65 life.year
 (Dutch; Fenger, 2018, (10))

However, Fenger (2018) demonstrates that the existential reading is possible in some imp-N languages such as Dutch and Swedish, while it is not in other imp-N languages like German, Danish or Norwegian as well as imp- ϕ languages. This is illustrated in (140).

- (140) Context: You are the owner of a restaurant. You can see that there is one empty plate at one table and a big tip.
- Intended: ‘**Someone** was served well here.’
- a. ***One** was served well here.
 - b. ***Man** wurde hier gut bedient.
 IMP was here good served (German)
 - c. **Men** werd hier goed bediend.
 IMP was here good served (Dutch; Fenger, 2018, (11))

The same property holds for unaccusatives as well, in which the pronoun starts out as an internal argument but ends up as the subject of the sentence. Whereas all languages allow the generic reading, Dutch and Swedish differ both from other imp-N languages as well as imp- ϕ languages in allowing an existential reading. Consider (141).

(141) Context: It has been freezing and the lake in the forest is frozen. However, there is a hole in the ice.

Intended: ‘Apparently, yesterday **someone** fell through the ice here.’

a. *Apparently, yesterday **one** has fallen through the ice here.

b. *Letzte Woche ist **man** hier eingebrochen.
last week is IMP here fallen.through (German)

c. **Men** is hier gister door het ijs gezakt..
IMP is here yesterday through the ice fallen (Dutch; Fenger, 2018, (13))

On the basis of the derived subjects, Fenger (2018) suggests that Cinque’s (1988) and Egerland’s (2003) generalization that only the impersonal pronouns that are external arguments may have generic and existential (arbitrary) readings does not capture the facts. She contends that it is not the syntactic position that matters, but case. In other words, it is not about whether an impersonal pronoun is underlying vs. derived subject, but it is about the surface position. Fenger (2018) also discusses the ECM construction to support her claim. Before looking at ECM, I investigate the status of the subject for Turkish impersonals.

Turning to Turkish, we see that impersonal pronouns in Turkish pattern like the majority of languages predicted by Cinque (1988) and Egerland (2003), and not like Swedish and Dutch. In other words, while the generic reading is possible with both the overt and null impersonal, as in (142), the existential reading is ruled out with derived subjects altogether, (143).

(142) *Generic*⁷²

⁷²According to the speakers I have consulted, (142a) and (142b) are interchangeable, an intuition I share. However, further research might reveal subtle differences between the two forms.

- a. **İnsan** hep kar-dan düş-üyor burada.
 one always snow-ABL fall-PROG here
 ‘One always falls here due to snow.’
- b. IMP hep kar-dan düş-ül-üyor burada.
 always snow-ABL fall-PASS-PROG here
 ‘It is always fallen here due to snow.’

(143) *Existential*

- a. ***İnsan** dün kar-dan düş-tü burada.
 one yesterday snow-ABL fall-PAST here
 ‘One fell here yesterday due to snow.’
- b. *IMP dün kar-dan düş-ül-dü burada.
 yesterday snow-ABL fall-PASS-PAST here
 ‘It was fallen here yesterday due to snow.’

Unaccusative predicates become possible with an iterative/habitual aspect, as in (144).

- (144) Türkiye-de her gün trafik kaza-lar-ı-nda öl-ün-ür-dü.
 Turkey-LOC every day traffic accident-PL-CM-LOC die-PASS-AOR-PAST
 ‘In Turkey it used to be died in traffic accidents every day.’
 (Nakipoğlu-Demiralp 2001, 140, with slight modification)

Now, I combine the properties of Germanic languages and Turkish impersonals in the same place, in Table 2.5 (leaving aside the facts about reciprocal binding).

Properties	imp- ϕ	imp-N		T- <i>insan</i>	T- <i>null</i>
		g/da/n	s/du		
(i) verbal agreement	3sg	3sg	3sg	3sg	3sg
(iia) generic inclusive reading	✓	✓	✓	✓	✓
(iib) existential reading, subject	*	✓	✓	*	✓
(iic) existential reading, derived subject	*	*	✓	*	*
(iii) object position	✓	*	*	✓	*

Table 2.5: Properties of impersonal pronouns (v2)

Looking at Table 2.5, we see that the overt impersonal *insan* ‘human’ in Turkish behaves like imp- ϕ , whereas the null impersonal exhibit the pattern of imp-N, particularly is similar to languages like German, Danish, Italian, Irish in disallowing an existential reading with

derived subjects (e.g., Fenger 2018; Cinque 1988; McCloskey 2007). Moreover, imp-N are subdivided into two categories, in which Swedish and Dutch (surprisingly) allow existential reading with derived subjects.

Fenger (2018) also looks at ECM constructions, based on which she provides support to her case-generalization that imp-N is restricted to nominative case, whereas imp- ϕ has no such restriction. Starting with the generic reading, we find that whereas imp- ϕ is possible in the ECM construction, (145a), imp-N is disallowed, as in (145b).

(145) Context: He is a station master.

Intended: ‘Therefore he always sees **people** leave for the holidays.’

a. The station master always sees **one** leave for the holidays.

b. *Daarom ziet hij **men** altijd op vakantie gaan.

Therefore sees he IMP always on vacation go (Dutch; Fenger, 2018, (8))

In the case of an ECM construction in which an existential reading is triggered, we see that there is no grammatical example in either imp- ϕ or imp-N languages.⁷³

(146) Context: I lay awake all night.

Intended: ‘I hear **someone** work on the road.’

a. *I hear **one** work(ing) on the road.

b. *Ik hoorde men aan de weg werken.

I heard IMP on the road work (Dutch; Fenger, 2018, (9))

Thus, Germanic languages suggest that the imp-N pronouns are never grammatical in an ECM construction and surface object positions, be it with a generic or existential reading, whereas imp- ϕ pronouns can be in the appropriate context. One point imp-N languages split is their behavior with respect to the existential reading with derived subjects. Whereas the majority of Germanic languages (as well as most languages) allow existential readings when the impersonal pronoun is an external argument and has nominative case, Swedish and Dutch do so in the nominative case, thus not caring about the status of the subject.

⁷³Note that in the case of generic reading, imp-N languages use the other impersonal of the form e.g. *ein*, *en* in ECM constructions while the dedicated *man*-form is ruled out. With the existential reading, even the *ein*, *en* forms are disallowed. See Fenger (2018, 9) for examples.

As Fenger (2018) points out, the ECM facts challenge the generalization Egerland (2003) and Cinque (1988) make regarding the external arguments for impersonals. Both researchers state that imp-N is restricted to occurring as an external argument. This predicts that the imp-N languages should allow the impersonal to be possible in an ECM construction, since the imp-N pronoun is an external argument in the lower clause. Yet, it is excluded in imp-N languages. Fenger (2018) also notes that another claim of Egerland (2003) and Cinque (1988), that is, imp-N pronouns can occur as an internal argument in passives and unaccusatives but only with a generic reading, also does not hold. The relevant data is shown in (141c) for Dutch, but Swedish also behaves identically. Given this background, Fenger (2018) provides the following table to summarize the facts.⁷⁴

	imp- ϕ	imp-N	
		A.	B.
Case	NOM, ACC	NOM	NOM
Underspecified subject, \exists	*	✓	✓
Derived subject, \exists	*	*	✓

Table 2.6: Generalizations of imp- ϕ vs imp-N
(Fenger, 2018, 13)

In the next section, I examine the ECM facts in Turkish for both the overt and null impersonal pronoun, and demonstrate that although the null impersonal is imp-N, interestingly it is possible in the ECM construction.

⁷⁴It is not clear which category the French impersonal *on* would fall into. Rezac and Jouitteau (2017, 165-167) provide some examples which suggest that French patterns like Swedish and Dutch, in allowing an existential reading with derived subjects. However, most of the examples are constructed in a way that involves some sort of ‘iterativity’ in them, which suggests that maybe they are in fact generic rather than existential. For instance, they provide the following contrast in (i) as evidence that derived subjects can be made good by manipulating salience.

- (i) a. A Beyrouth, quand **on** est tué, les médias le passent souvent sous silence.
In Beyrouth, when $ON_{\approx \text{people}}$ is killed, the medias often pass it over in silence.
- b. *Aujourd’hui a Beyrouth, **on** a été tué sans raison.
Today in Beyrouth, ON has been killed without reason.
- c. ?Aujourd’hui à Beyrouth, **on** a encore été tué pour rien; il faut que ça s’arrête.
Today in Beyrouth, $ON_{\approx(?)1+\text{persons}}$ has again been killed for nothing; it must stop.
(Rezac and Jouitteau, 2017, 165)

Further investigation is needed, I believe, to decide on French.

2.3.1.2 ECM in Turkish

As background, in Turkish a simple sentence can be embedded under the verb *san-* ‘believe, think, assume’ in three ways (Kornfilt, 1984, 1977; Zidani-Eroğlu, 1997; Öztürk, 2005, a.o.). In the first case, the complement clause is finite, and the embedded verb bears tense and agreement.

- (147) (Siz) [ben Ali-yi gör-dü-m] san-ıyor-sunuz.
 you.NOM [I.NOM Ali-ACC see-PAST-1SG] think-PROG-2PL
 ‘You think that I saw Ali.’ (Zidani-Eroğlu, 1997, (4))

In the second case, *san-* takes the nominalizing *-DIK-* complement whose subject has genitive Case and whose verb has nominal agreement, resembling the internal structure of genitive NPs.

- (148) (Siz) [ben-im Ali-yi gör-düğ-üm]-ü san-ıyor-sunuz.
 you.NOM [I-GEN Ali-ACC see-NMLZ-1SG]-ACC think-PROG-2PL
 ‘You assume my seeing Ali.’ (Zidani-Eroğlu, 1997, (5))

In the third case, embedding under *san-* can give rise to an ECM construction where the embedded thematic subject surfaces with accusative Case.

- (149) a. (Siz) [ben-i Ali-yi gör-dü] san-ıyor-sunuz.
 you.NOM [I-ACC Ali-ACC see-PAST.3SG] think-PROG-2PL
 ‘You believe me to have seen Ali.’
 b. (Siz) [ben-i Ali-yi gör-ecek] san-ıyor-sunuz.
 you.NOM [I-ACC Ali-ACC see-FUT.3SG] think-PROG-2PL
 ‘You believe me to be going to see Ali.’⁷⁵ (Zidani-Eroğlu, 1997, (6))

Let us first look at the overt impersonal, i.e. *imp-φ* in Turkish. Expectedly, it is grammatical in the ECM construction, as shown in (150). This fits in with the crosslinguistic pattern.

- (150) Context: In the office the employees assume that if someone likes the Facebook post about the annual New Year’s party, then they will attend the party.

⁷⁵ Zidani-Eroğlu (1997) suggests that the embedded verb in ECM lacks Agr features on the verb. Although I accord with the judgments given here, Şener (2008) argues that most speakers also accept the version in which the embedded verb bears Agr features. This point makes no difference for the discussion here.

Çalışan-lar **insan-ı** parti-ye gel-ecek san-ır-lar.
 employee-PL one-ACC party-DAT come-FUT think-AOR-PL
 ‘The employees believe one to be coming to the party.’

Similarly, the overt impersonal is possible in the complement of verbs that select for a small clause, as illustrated in (151).

(151) Bu köy-de **insan-ı** hemen deli diye damgala-r-lar.
 this village-LOC one-ACC right.away crazy as label-AOR-PL
 ‘They immediately label one crazy in this village.’

Now let us turn to the null impersonal, which we have seen is an imp-N pronoun. It turns out determining whether the impersonal pronoun occurs in an ECM is not that straightforward. Given that the impersonal pronoun is null and the agreement is 3rd person default, a sentence like (152) in which the embedded clause is impersonal since it has an unergative verb, is ambiguous between a finite complement and an ECM construction. This is because we cannot make use of the accusative case on the thematic subject (or the agreement on the verb for speakers allowing it in ECM, see fn. 75) as a diagnostic for the ECM construction.

(152) (Siz) [IMP dans ed-il-iyor] san-ıyor-sunuz.
 you.NOM [dance do-PASS-PROG.3SG] think-PROG-2PL
 i. ‘You think that people are dancing.’
 ii. ‘You believe people to be dancing.’

In order to confirm that imp-N really occurs in an ECM construction, I make use of the modification by an adverb diagnostic, discussed in Zidani-Eroğlu (1997). The imperfective temporal adverb *sabahtan beri* ‘since morning’ is compatible only with imperfective predicates. The contrast is shown between (153) and (154) ((12a) and (12b), respectively, in Kornfilt 1977).⁷⁶

(153) *Zeynep sabah-tan beri öp-ül-dü.
 Zeynep.NOM morning-ABL since kiss-PASS-PST.3SG
 ‘Zeynep was kissed since this morning.’

⁷⁶The background examples are mostly from Zidani-Eroğlu (1997).

- (154) Zeynep sabah-tan beri öp-ül-üyor.
 Zeynep.NOM morning-ABL since kiss-PASS-PROG.3SG
 ‘Zeynep is being kissed since this morning.’

In a finite complement, the adverb immediately preceding the embedded subject can modify the imperfective matrix predicate *san-* ‘think’.

- (155) (Siz) sabah-tan beri [Orhan öp-ül-dü] san-ıyor-sunuz.
 you.NOM morning-ABL since [Orhan.NOM kiss-PASS-PST.3SG] think-PROG-2PL
 ‘You have been thinking since this morning that Orhan was kissed.’

However, the adverb fails to modify the imperfective matrix predicate when it follows the embedded subject.

- (156) *(Siz) [Orhan sabah-tan beri öp-ül-dü] san-ıyor-sunuz.
 you.NOM [Orhan.NOM morning-ABL since kiss-PASS-PST.3SG] think-PROG-2PL
Intended: ‘You have been thinking since this morning that Orhan was kissed.’

Conversely, from the position it occupies in (156), the adverb can modify the imperfective matrix predicate in an ECM construction, as shown in (157).

- (157) (Siz) [Orhan-ı sabah-tan beri öp-ül-dü] san-ıyor-sunuz.
 you.NOM [Orhan-ACC morning-ABL since kiss-PASS-PST.3SG] think-PROG-2PL
 ‘You believe Orhan to have been kissed since this morning.’
 (the belief has been going on since this morning)

Zidani-Eroğlu (1997) takes the possibility of such modification as an indication that the adverb is in the matrix clause, and therefore the ECM NP must occupy a position in that clause as well. Applying the adverb diagnostic to the sentence in (152), we see that the adverb can modify not only the embedded imperfective predicate, but crucially also the matrix imperfective predicate, which indicates that the impersonal pronoun is in an ECM construction.

Postal (1974, 146-8) provides a similar contrast in English cases, shown in (158) and (159). In these sentences, the a-sentence is unambiguous, the adverb having only the embedded scope. The b-sentences, on the other hand, are all ambiguous, between the matrix

and embedded construal of the adverb. The a-sentences invite the conclusion that adverbs are interpreted in the clause that they are contained in. Assuming this to be the case, the ambiguity of the b-sentences must be accounted for by assuming two possible structural positions for the adverb: one in the embedded clause and in the main clause. The latter in turn presupposes that the embedded subject, which occurs to the left of the adverb, be contained in the main clause as well.⁷⁷

- (158) a. Jane proved that Bob, unfortunately, was a werewolf.
 b. Jane proved Bob, unfortunately, to be a werewolf.
- (159) a. I believed that Nixon, incorrectly, was interested in ending the war.
 b. I believed Nixon, incorrectly, to be interested in ending the war.

Still, the adverb alone is not enough to tell us whether it is a finite complement or an ECM construction. Therefore, the two possible readings of (160) can be because of (i)-(ii), that is, an ECM construction, but it can also be due to (iii)-(iv), in which we have a finite complement clause.

- (160) (Siz) sabahtan beri dans ed-il-iyor san-iyor-sunuz.
 you.NOM morning-ABL since dance do-PASS-PROG.3SG think-PROG-2PL
- i. ‘You believe people to be dancing since this morning.’
 ii. ‘You, since this morning, believe people to be dancing.’
 iii. ‘You think that people are dancing since this morning.’
 iv. ‘You have been thinking since this morning that people are dancing.’

The same issue arises also when the embedded predicate has the perfective aspect, then the adverb may only modify the imperfective matrix predicate. Since the thematic impersonal subject is null, it is not clear if we have an ECM construction, in which the impersonal pro-

⁷⁷Postal (1974, 148) shows that an alternative explanation, which would hold that infinitival clauses are somehow transparent for adverb scope, is cannot be correct. This can be seen with non-finite complements introduced by a *for*-complementizer: these do not allow adverbs contained in them to have matrix scope:

- (i) a. I arranged for Bob recently to meet my niece.
 b. I arranged for Bob to recently meet my niece.

noun raises to get accusative case or a finite complement, in which the impersonal pronoun gets nominative case.

- (161) (Siz) sabahtan beri dans ed-il-di san-iyor-sunuz.
 you.NOM morning-ABL since dance do-PASS-PAST.3SG think-PROG-2PL
 i. ‘You, since this morning, believe people._{ACC} to have danced.’
 ii. ‘You have been thinking since this morning that people._{NOM} danced.’

As a solution to this problem, I employ sentences which contain a non-structural dative argument, e.g. a benefactive. Tonyalı (2015) demonstrates that Turkish is a high-applicative language, given the possibility of applicative arguments with unergative predicates (among other reasons; see Tonyalı (2015) for further discussion of non-structural datives in Turkish).

- (162) Başbakan-ımız-a dans et-mek isti-yor-um.
 prime minister-1POSS.PL-DAT dance do-INF want-PROG-1SG
 ‘I’d like to dance for our Prime Minister.’ (Tonyalı, 2015, (22))

Constructing an example of the sort in (162), we have an overt element, i.e. the benefactive, relative to which we can see the word order of the adverb *sabahtan beri* ‘since morning’.

In a finite complement with an active clause, the adverb which follows the benefactive DP fails to modify the imperfective matrix verb.

- (163) *(Siz) [Orhan Başbakan-a sabah-tan beri dans et-ti]
 you.NOM [Orhan.NOM prime minister-DAT morning-ABL since dance do-PST.3SG]
 san-iyor-sunuz.
 think-PROG-2PL
Intended: ‘You have been thinking since this morning that Orhan danced for the Prime Minister.’

Similar to the example of Zidani-Eroğlu (1997) in (157), from the position it occupies in (163), the adverb can modify the imperfective matrix predicate in an ECM construction.

- (164) (Siz) [Orhan-ı Başbakan-a sabah-tan beri dans et-ti]
 you.NOM [Orhan-ACC prime minister-DAT morning-ABL since dance do-PST.3SG]
 san-iyor-sunuz.
 think-PROG-2PL
 ‘You believe Orhan to have danced for the Prime Minister since this morning.’

Properties	imp- ϕ	imp-N		T- <i>insan</i>	T- <i>null</i>
	e/fri/i	g/da/n	s/du		
(i) verbal agreement	3sg	3sg	3sg	3sg	3sg
(iia) generic inclusive reading	✓	✓	✓	✓	✓
(iib) existential reading, subject	*	✓	✓	*	✓
(iic) existential reading, derived subject	*	*	✓	*	*
(iii) object position	✓	*	*	✓	*
(iv) ECM	✓	*	*	✓	✓

Table 2.7: Properties of impersonal pronouns (final)

(the belief has been going on since this morning)

In cases where the embedded clause is an impersonal, the adverb can also modify the matrix predicate, which suggests that it is an ECM construction. Consider (165).

- (165) (Siz) IMP Başbakan-a sabah-tan beri dans ed-il-di
 you.NOM prime minister-DAT morning-ABL since dance do-PASS-PST.3SG
 san-iyor-sunuz.
 think-PROG-2PL

‘You believe people to have danced for the Prime Minister since this morning.’

(the belief has been going on since this morning)

We can summarize all the properties thus far in Table 2.7, where the uncommon properties are shown in a square.

Table 2.7 demonstrates that the overt impersonal *insan* in Turkish shows the same behavior as imp- ϕ in other languages. The null impersonal, on the other hand, in many respects behaves like German, Danish type imp-N languages, which are disallowed with derived subjects in the existential reading. However, it crucially differs from them in being licensed in an ECM construction.

2.3.2 Towards an account

In this section, I attempt to give an explanation that captures the variation across languages, as well as the restricted nature of this variation.

The empirical picture we would like to capture is the split within the imp-N pronouns

with respect to the status of the subject and case. Languages such as Dutch and Swedish always allow existential readings in the nominative, whereas Danish, German and Norwegian only allow existential readings when it is an external argument and has nominative case. On the other hand, the imp-N in Turkish always allow existential readings when it is an external argument, regardless of the case. This explains why it is ungrammatical as the transitive object or the sole argument of an unaccusative predicate, but is licit in the ECM construction. In the former two instances, the impersonal is not an external argument, whereas in the latter instance, it is an external argument in the lower clause, though it ends up getting accusative case.

I suggest that the distributional properties of impersonal pronouns derives from the combination of two privative features: [EA], [GEN], and a binary case feature [\pm NOM]. [EA] stands for the external argumenthood, and [GEN] for the generic interpretation (I leave aside the non-trivial questions of why these features matter, and how are they derived). Languages, more precisely different types of impersonals even within a single language, differ with respect to which of these features they are sensitive to. The attested combinations can be summarized in Table 2.8.⁷⁸

a. <i>null</i> -impersonal in Turkish	: if [EA] \rightarrow \exists or [GEN], if not \rightarrow [GEN] ⁷⁹
b. <i>man</i> -type in German, Danish	: [EA, +NOM] \rightarrow \exists or [GEN]
c. <i>men</i> -type in Dutch, Swedish	: [+NOM]
d. <i>ein</i> -type <i>imp-ϕ</i> in German, Danish	: [-NOM, GEN]
e. <i>one</i> -type impersonal, <i>insan</i> in Turkish	: [GEN]

Table 2.8: Patterns of impersonals

The feature combination [+NOM, EA] in a. indicates that the impersonal is required to be an external argument and in a nominative case position. German, Danish have the dedicated impersonal that imposes this restriction. The null impersonal in Turkish can be captured

⁷⁸It is possible to derive the patterns with different feature specifications, e.g. binary features altogether. However, it seems to me that approach would predict a much larger set of patterns that are not (or have not been) found. The current version is more restricted in that sense.

⁷⁹For the sake of simplicity, I am overlooking the fact that external argument requirement exists only with the existential reading.

via the feature [EA], which means that as long as the impersonal is an external argument, it is licensed. This feature allows us to capture the fact that the null impersonal is also licensed in ECM. Note that this feature shows that Fenger’s (2018) attempt to reduce the facts to a case-generalization does not extend to Turkish. The feature set in c. [+NOM] explains the distribution of imp-N in languages such as Dutch and Swedish.

The feature [-NOM, GEN] refers to the alternative pronoun that can occur in object position, in languages with imp-N pronoun (except for Dutch). This pronoun can only have a generic inclusive reading. In (166) an example is given for German, a language with an imp-N pronoun which has an accusative form.

- (166) Es spielt gar keine Rolle, wer **man** ist oder wie man aussieht, solange
 It plays completely no role, who IMP is or how IMP out.look, as
einen / ***man** nur jemand liebt.
 IMP.ACC / IMP now somebody loves
 ‘It doesn’t matter who you are or what you look like, so long as somebody loves you.’
 (Roald Dahl, *The Witches*) (German; Fenger, 2018, (7))

When we look at the ECM construction, we see that this alternative pronoun is possible only with the generic interpretation, (167a), but not with the existential one, as in (167b).

- (167) a. Context: He is a station master.
 Intended: ‘Therefore he always sees people leave for the holidays’
 Der Bahnhofswärter sieht **einen** immer in die Ferien fahren.
 The train.conductor sees IMP always in the holiday go
 ‘The station master always sees one leave for the holidays.’
- b. Context: I lay awake all night.
 Intended: ‘I hear **someone** work on the road.’
 *Ich habe **einen** auf/an der Strasse arbeiten hören.
 I have IMP on the road work hear
 ‘I hear one work(ing) on the road.’ (German, Fenger, 2018, (8-9))

Therefore, the alternative impersonal pronoun requires a non-nominative case, presumably accusative, and a generic interpretation. The binary case feature allows us to capture this

case. Another way to think about this is that, at least when an NP is local to T, KP will not project, even when the element starts as an internal argument (since the NP can be a derived subject).

The system, in its current form, makes a wrong prediction with respect to the possibility of the null impersonal in Turkish, of imp-N type, in the ECM construction. It prevents imp-N from occurring in object position or as an ECM-subject, since then it will project a KP layer. However, we have seen that the null impersonal in Turkish can occur as an ECM-subject.

2.4 Chapter summary

This chapter has investigated the properties of null and overt impersonals in Turkish, focusing on various constructions, such as ‘passives of passives’, Negation-Licensed Commands, and the overt impersonal *insan* in Turkish.

I establish the existence of two distinct constructions with identical morphology: (i) passive, and (ii) an impersonal, in which there is no argument demotion – an unpronounced impersonal pronoun fills the argument position, and is licensed by a functional head *Impers* that occurs above Voice. The investigation also has revealed that the purported passives of passives in Turkish are in fact impersonals of passives, thus supporting the original claim by Perlmutter and Postal (1977, et seq) that passive verbs cannot undergo passivization.

The chapter has argued that the null impersonal is also found in Negation-Licensed Commands, which are essentially nominalizations that become commands in the presence of negation.

The last part of the chapter has examined the behavior of the overt impersonal *insan* in Turkish, and showed that it is not just a pronounced counterpart of the null impersonal, but rather has a different status, with more functional structure. I have also demonstrated that Turkish impersonals do not neatly fit into recent classifications of e.g. imp- ϕ vs. imp-N of Egerland 2003 (see also Fenger 2018, Ackema and Neeleman 2018).

Chapter 3

Causatives in Sason Arabic

Sason Arabic is an endangered Arabic variety spoken in south-eastern Turkey in the highlighted region in the following map (Jastrow 1978; Akkuş 2017; Akkuş and Benmamoun 2018).¹ It is one of the so-called peripheral Arabic varieties, a term that refers to Arabic varieties spoken in non-Arab countries (Akkuş 2017).

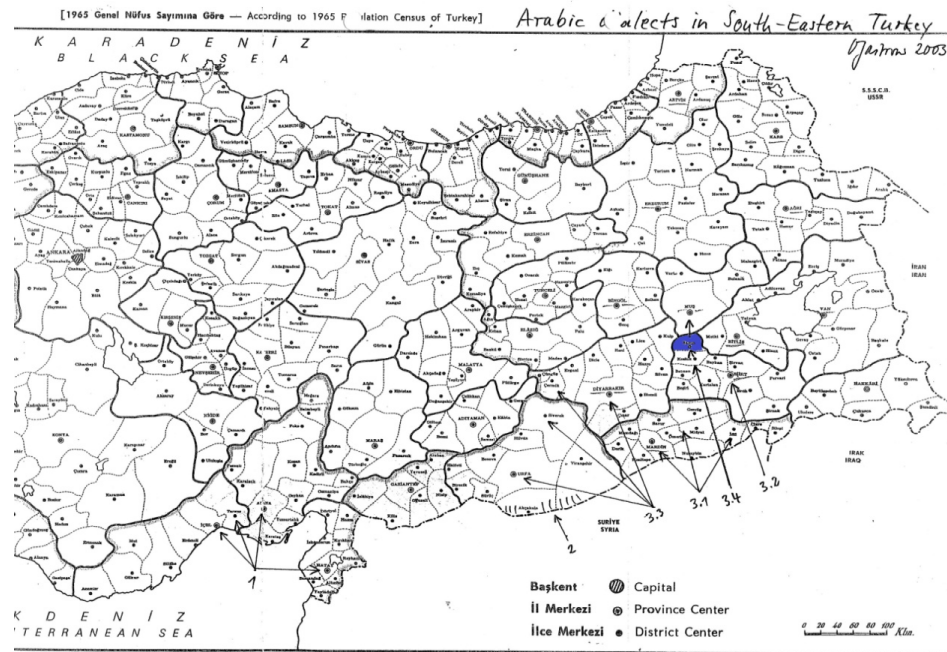

SA is mostly head-initial in verbal clauses (Akkuş and Benmamoun 2018). The base order SVO can be obscured by scrambling of arguments and adjuncts. Nonverbal clauses are head-final due to contact with Turkish and Zazaki (Indo-Iranian) (Akkuş 2020a).

¹The map is from Jastrow (2006). Highlight mine, with permission of Otto Jastrow.

In Classical Arabic and in modern varieties spoken in the Arab world, the indefinite noun phrase is unmarked or is preceded by an independent indefinite particle, whereas an NP becomes definite by prefixing the definite article *al-*, *əl-*, *il-*. However, Kozluk-Sason-Muş group dialects have adopted the reverse pattern (see also Uzbekistan Arabic; Jastrow 2005), which is found in the neighboring languages Turkish and Kurdish.

- (169) *mara* ‘(the) woman’ *mara-ma* ‘a woman’
bayt ‘(the) house’ *bayt-ma* ‘a house’

That is, the definite NP is left unmarked, and the enclitic *-ma* ‘a, some’ is used to mark the indefiniteness of an NP (Akkuş 2016, 2017; Akkuş and Benmamoun 2018).

3.1 Types of causatives in Sason Arabic

In this section I briefly introduce the causativization strategies in SA.²

SA has four ways of expressing causatives, two of which are via morphological processes, i.e. ablaut and gemination, and the other two being periphrastic causatives, i.e. ‘give’ and ‘make’ causatives. Ablaut and gemination strategies are found in other Arabic varieties as well (Kuryłowicz 1957; Fassi Fehri 1987; Benmamoun 1991; Hallman 2006, i.a.).³

For the ablaut process, causative verbs may be formed from unaccusatives by changing the stem vowel in most cases (Kuryłowicz 1957, see also Saad 1982, 66; Hallman 2006; Fassi Fehri 1987). This property, which is found primarily in Classical Arabic or to a very limited extent in colloquial varieties, also holds in SA although it is not as prevalent.

²Various parts of this chapter have appeared in *Journal of Linguistics*, *Linguistic Inquiry* and *Syntax*.

³Sason Arabic has lost the so-called X theme *?istaffala*, where the causative theme starts with *š* and *t* is used to express the reflexive idea. For instance, the root *KTB* ‘write’ has the X pattern of the form *(ʔi)staktaba*. Arabic also has analytical causatives formed with verbs such as *jaʕala* ‘to make’ or *taraka* ‘to let’ (e.g. Saad 1982, 82; Alrashed 2012, 209-216). However these verbs embed a finite structure in which the embedded verb carries agreement. I leave their discussion aside.

It is worth noting from the outset that not all causative strategies are available or found in the grammars of all speakers or sub-varieties. For instance, ‘make’-causatives that embed an infinitive are found in the grammars of a smaller group of speakers compared to ‘give’ causatives and ‘make’ that embeds a finite clause, which are also not available for all speakers. Even within the last two strategies, speakers have different preferences regarding word orders etc. In fact, speakers might have strong opinions about the constructions that are not found in their own grammars, some calling the speech forms of others as ‘bad Arabic’, or ‘wrong Arabic’ especially if they have not encountered a usage before. For the purposes of this dissertation, I abstract away from this significant point.

Consider (170) and (171).

- (170) a. *şelç zay*
snow melted
'Snow melted.'
- b. *zay-tu şelç*
melted-1SG snow
'I melted snow.'
- (171) a. *lāke tal-e*
stain came.out-3F
'The stain came out.'
- b. *tel-tu lāke*
came.out.CAUS-1SG stain
'I got the stain out.'

In the context of the gemination strategy, the causative affix is realized by geminating the second radical of the stem. Geminate causatives formed from the unaccusative bases may not express indirect causative reading (just like the ablaut strategy), similar to their counterparts in other Arabic varieties (e.g. Saad 1982, ch. 3, Benmamoun 1991, Hallman 2006). This is illustrated in (173). (172) are examples from Modern Standard Arabic from Hallman 2006 (see also 173 for an example from Sason Arabic).

- (172) a. *xalā (be vacant) → xallā (to vacate, *cause sb to vacate sth)*
b. *xariba (be destroyed) → xarraba (destroy, *cause sb to destroy sth)*

Geminates formed from unaccusative bases may not express an indirect causative reading (just like the ablaut strategy), similar to their counterparts in other Arabic varieties.

- (173) a. *xaser xireb.*
yoghurt spoiled.3M
'The yoghurt spoiled.'
- b. *leyla xarrīb-e xaser.*
Leyla spoiled.CAUS-3F yoghurt
'Leyla spoiled the yoghurt.'
- NOT: 'Leyla caused someone to spoil the yoghurt.'

- c. xaser m-xarreb (mi leyla).
 yoghurt PASS-spoiled.CAUS.3M by Leyla
 ‘The yoghurt was spoiled (by Leyla).’

Overall, the sequence of morphemes found in the causative construction in SA directly supports the broad structure of causatives arrived at by other researchers working within the type of framework assumed here (see, e.g., Alexiadou et al. 2006; Marantz 2008; Pytkänen 2008; Harley 2013; Legate 2014). As shown in (174), the whole is a simple transitive verb phrase, consisting of a VoiceP, the causative vP, which is specified as ablaut or geminate, and the phrase headed by the root. (174a) is the structure for the active clause in (173b), and (174b) is the configuration for the passive (173c).

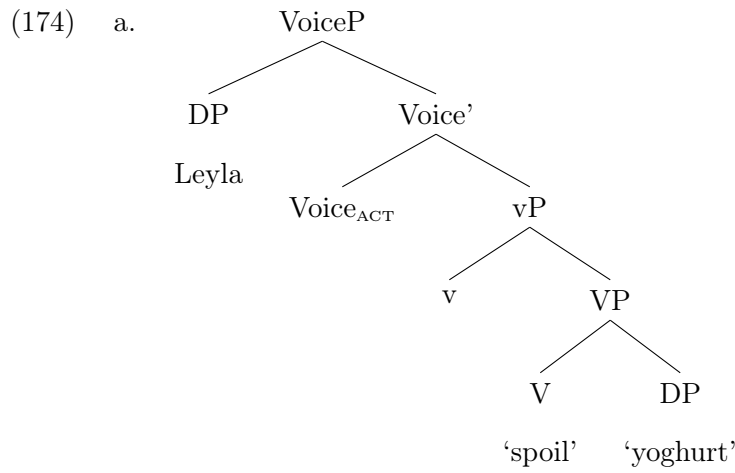

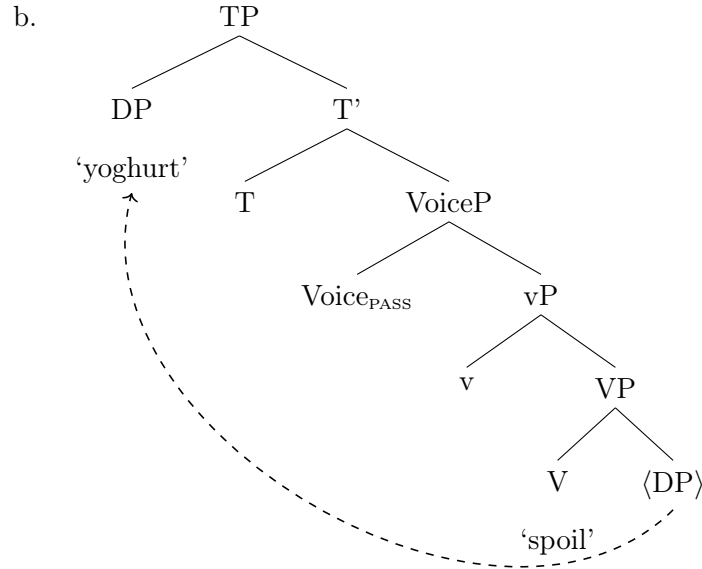

Gemination is less restricted than ablaut. Transitive verbs may also show a geminate causative counterpart, and the causee of an underlyingly transitive verb may be expressed either as a DP or a PP headed by *(mi)ša* ‘to, for’, as in (175b) and (175c), respectively.⁴

- (175) a. kemal ku i-qri lala kitab
 kemal be.3M 3M-read.IPFV this.M book
 ‘Kemal is reading this book.’
- b. oratman ki tı-qarri kemal lala kitab
 teacher be.3F 3F-read.CAUS Kemal this.M book
 ‘The teacher is making Kemal read this book.’ (Yakut, 2013, 33a)
- c. oratman ki tı-qarri lala kitab miša kemal
 teacher be.3F 3F-read.CAUS this.M book to Kemal
 ‘The teacher is making Kemal read this book.’ (Yakut, 2013, 33b)

⁴ As in other Semitic languages, not all instances of gemination in SA result in a causative reading, thus Form II, the *faʿʿal* template is used both for causative verbs as well as for basic entries in the lexicon, e.g. *mawwal* ‘finance’, *zayyaf* ‘forge’, although few non-causativized verbs in SA seem to have this pattern. It is worth pointing out that the possibility of non-causative interpretation for certain entries does not mean that causativization is not derived in syntax. See Benmamoun (1991) for a syntactic approach to geminates in Moroccan Arabic. One approach would be to assume (with Arad (2003, 2005) for Hebrew, Tucker (2011) for Arabic) that within the Distributed Morphology framework, an acategorial Root is the consonantal root, and the categorizing head it adjoins to is the phonological instantiation of the template. What could be differentiating the geminate causatives from other geminated non-causative lexical items is that in the former the categorizing *v* is dominated by another *v*, which we can call v_{CAUS} . Although how the morphophonology of gemination works is a significant question, the discussion falls outside the scope of this dissertation since the focus here is on the embedded structures in various periphrastic or morphological causatives.

In addition to the root and pattern strategies, SA exhibits two periphrastic causative constructions (Akkuş 2020a). The periphrastic causative formed with the light verb ‘give’ allows the causee to be introduced only as a PP headed by *(mi)şa* ‘to, for’. The embedded verb is in infinitival form. Consider (176). This construction is calqued on the Kurdish periphrastic causative, which uses the light verb *bûdîn* ‘give’.

- (176) a. *ado dolab-ad-en (şa tamirci) addil*
 gave.3PL shelf-PL-their (to repairman) make
 ‘They had their shelves done.’

(Lit: They gave their shelves to the repairman to fixing)

- b. *imm-a mîşa fatma şî adîd-u addil*
 mother-her to Fatma food gave.3F-it.M make
 ‘Her mother had Fatma cook.’

(Lit: The food, her mother gave it to Fatma to fixing) (Erguvanlı-Taylan, 2017, 221:(30))

SA has another type of indirect causative embedded under the verb ‘make’.⁵

- (177) *mafya sa qadîl hasm-u*
 mafia made murder.INF enemy-his
 ‘The mafia leader made someone murder his enemy.’

Note that there is no overt argument/morpheme corresponding to the causee in (177). This construction differs from the previous strategies in not allowing the implicit causee to be overtly expressed, be it as a DP, (178a), or a PP headed by ‘to, for’, (178b), regardless of the definiteness. In contrast, as illustrated in (178c), a PP headed by the preposition *mi* ‘by, from’ is licit with an indefinite noun phrase (see section 3.2.1.1.6 for more discussion of this possibility).

- (178) a. **mafya sa nes-ma gbir / nes-ma / tamirci qadîl hasm-u*
 mafia made person-a big / person-a / repairman murder.INF enemy-his
 ‘The mafia leader made a big person / someone / the repairman murder his

⁵In most cases, I provide as literal a translation as possible for the sentences discussed. However, I do not assign a grammaticality judgment to those translations. Grammaticality judgments are assigned only to the Sason Arabic sentences.

- enemy.’
- b. *mafya sa qadil hasm-u *mı̄şa nes-ma gbir* / *nes-ma* /
 mafia made murder.INF enemy-his to person-a big / person-a /
tamirci.
 repairman
 ‘The mafia leader made his enemy murdered by a big person / someone / the
 repairman.’
- c. mafya sa qadil hasm-u ✓ *mı̄ nes-ma gbir* / ✓/? *mı̄ nes-ma* /
 mafia made murder.INF enemy-his by person-a big / by person-a /
 **mı̄ tamirci*.
 by repairman
 ‘The mafia leader made his enemy murdered by a big person / someone / *the
 repairman.’

In the first part of the chapter I investigate ‘make’-causatives, followed by geminates and ‘give’ causatives. For ‘make’-causatives, I proceed with the investigation of the syntax of the embedded clause in ‘make’ causatives, which I argue embeds three structures: (i) a passive VoiceP, (ii) an active VoiceP with embedded agent as a free variable, and (iii) an active VoiceP with a full DP embedded agent, which is subject to locality restrictions. The second part of the chapter examines ‘give’ causatives and geminates in SA. I propose that in these causative strategies embed a different voice, precisely CauseeP, which assigns Causee θ -role to the agent of the caused event.

3.2 ‘make’ causatives in Sason Arabic

As illustrated in (177), SA has a type of indirect causative embedded under the verb ‘make’. As further examples in (179) indicate, it is a construction with an overt embedded theme argument, but no overt embedded agent. The verb appears in infinitival form. It maintains an agentive reading where the embedded agent is interpreted as indefinite ‘someone’ or ‘some people’.

- (179) a. dāde sa-tte nazf haydan
 mom made-3F clean.INF wall
 ‘Mom made (someone) clean the wall.’
- b. dāde sa-tte nazf haydan mi nes-ma tawwil.
 mom made-3F clean.INF wall by person-a tall
 ‘Mom had the wall cleaned by someone tall.’

This section of the chapter investigates this construction with a focus on (i) the syntax of the structure(s) ‘make’ embeds, and (ii) the syntax and semantics of the implicit embedded agent. With respect to the first point, a bare VP analysis has been suggested for similar constructions, e.g. Swedish (Lundin, 2003), Hiaki (Harley, 2013), Hindi (Ramchand, 2006), Italian (Folli and Harley, 2007), Icelandic (Wood, 2011; Wood and Á. Sigurðsson, 2014), a.o. As such, the causativizing verb embeds a VP, and no higher projection(s). I argue that in SA ‘make’ embeds a reduced structure (cf. *restructuring* of Wurmbrand 2001 et seq), precisely no AspP or higher projections, but contains (at least) a thematic VoiceP, which exhibits an active-passive alternation despite the absence of any morphological reflex. As such, this contributes to the typologies of Voice and of causatives (cf. Schäfer 2008; Schäfer 2017; Alexiadou and Anagnostopoulou 2004; Harley 2013; Legate 2014; Pitteroff 2015).

As to the second point, the question is what is the status of the *implicit argument*, i.e. the semantically understood, but missing nominal element, in (179a)? Implicit arguments have played a central role in syntactic theorizing, since reference to non-overt arguments is made in a wide range of syntactic phenomena. Does the implicit argument participate in grammatical dependencies/processes? (Williams 1985; Rizzi 1986; Roeper 1987; Baker et al. 1989; Bhatt and Pancheva 2006, 2017; Landau 2010; Legate 2014; Collins 2018a,b, i.a.) In other words, is the implicit argument syntactically projected in the active complement of ‘make’ when the agent is not realized overtly. For instance, Bhatt and Pancheva (2006, 2017) conclude that in some cases implicit arguments seem to be syntactically active, but that there is no good evidence to suggest that they are syntactically projected. Landau (2010) claims that some implicit arguments are syntactically real and can be split into strong implicit arguments (SIAs) and weak implicit arguments (WIAs). SIAs have ϕ -features and a D feature, which

takes an NP predicate and turns it into a syntactic argument (Longobardi 1994; Heim and Kratzer 1998). WIAs have only a set of ϕ -features allowing the implicit argument to be involved in a limited set of syntactic relations e.g., control, but not binding. Legate (2014) argues that implicit arguments indeed vary crosslinguistically from fully projected as e.g., in the impersonal, to partially projected as e.g., in the grammatical object passive. In contrast, canonical passives lack a projected implicit agent. Under Legate’s analysis, fully projected and partially projected arguments in Spec,VoiceP are enough for the Voice head to assign accusative case, whereas the absence of the implicit argument causes the theme to receive nominative case. Previous suggestions vary from treating the implicit argument as *pro* (like a pro-dropped argument), (180), to taking it on par with a missing ‘by’-phrase, (181), due to the existential interpretation. The previous suggestions for implicit arguments can be summarized as follows: in (180) the agent is both semantically and syntactically present; in (181), it is semantically present, but not syntactically.

(180) *pro*

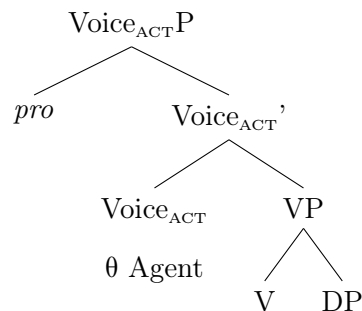

(181) *existential*

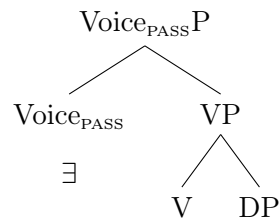

Another option is to suggest that the implicit argument is not available even semantically, i.e. the Voice projection is absent altogether. This is illustrated in (182).

(182) *no thematic Voice*

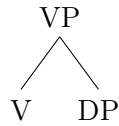

In this chapter, I argue that the embedded agent in ‘make’-causatives is neither *pro*, thus not syntactically projected into the specifier of the embedded VoiceP, nor an *existential passive agent*. Instead, I provide arguments to demonstrate that it is a “free variable” (à la Heim’s (1982) analysis of indefinites) on the active Voice.⁶ Moreover, in (179a), the embedded structure is active Voice, whereas it is passive Voice in (179b).

(183) *active VoiceP*

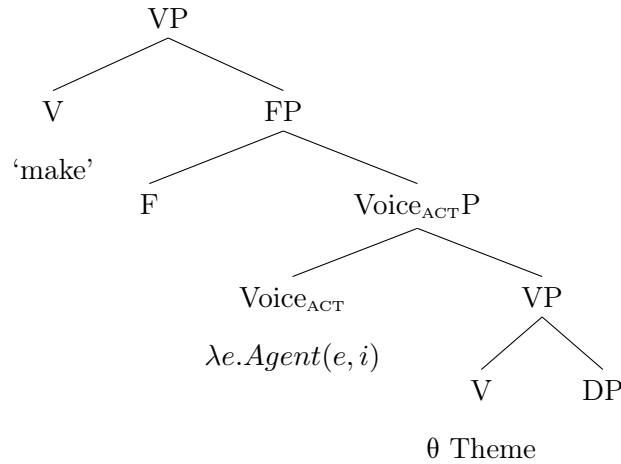

(184) *passive VoiceP*

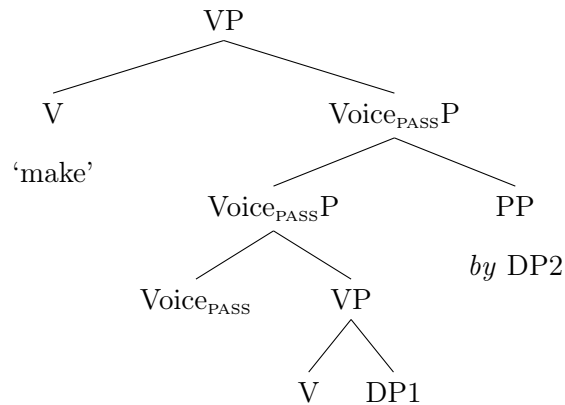

⁶I will come back to FP later in the chapter.

The free variable on thematic, active Voice differs in its properties from the implicit passive agent as well as other instances in which the null argument is interpreted existentially. For instance, implicit agents of passives or indefinite implicit objects cannot antecede pronouns occurring subsequently in the clause or in a subsequent clause. However, such pronouns corresponding to the embedded agent are possible in ‘make’-causatives. Therefore, the exploration of this construction also gives important insights to the typology of implicit arguments. The possibility of the embedded agent being introduced on the Voice head implies that the licensing of a grammatical object is possible for VoiceP, and not dependent on the projection of a specifier, be it in the form of a grammatical subject (cf. Burzio’s (1986) generalization; also see Marantz 1991; Woolford 2003; McFadden 2004), or as ϕ -features, i.e., the weak implicit argument, in Spec,VoiceP (Legate 2014). The discussion provides support to the claim by Šereikaitė (2018, 2020), who suggests that a thematic Voice head is sufficient for the assignment of accusative on the basis of Lithuanian root clauses, which she calls *active existential*.

As mentioned above, the embedded agent is obligatorily null, and cannot be pronounced in-situ. Consider (185).

- (185) *dāde sa-tte nes-ma tawwil / nes-ma nazf haydan.
 mom made-3F person-a tall / person-a clean wall
 ‘Mom had someone tall / someone wash the wall.’

Notably, \bar{A} -movement (*wh*-question, relativization, focus) licenses overt realization of the embedded agent.

- (186) *wh*-question
 ande mafya sa qadil hasm-u?
 who mafia made murder.INF enemy-his
 ‘Who did the mafia leader make murder his enemy?’
- (187) relativization
 sima-tu mi nes-ma tawwil le dāde sa-tte nazf haydan.
 heard-1SG by person-a tall that mom made-3F clean wall
 ‘I’ve heard about some tall person that mom made clean the wall.’

(188) contrastive focus

nes-ma gbir mafya sa qadil hasm-u (nes-ma istudi lā)
person-a big mafia made murder enemy-his (person-a small no)

‘A big person, the mafia made murder his enemy (not a small one).’

This phenomenon has been observed in a number of unrelated languages, in which arguments cannot remain in their base-generated position, and need to move to be ‘rescued’. As such, certain positions cannot be occupied by overt material at Spell-Out. Examples from English are provided in (189).

(189) a. *John wagered the woman to know French. (Bošković, 2002, (53))

b. Who did John wager to know French?

The nature of this phenomenon has remained as a long-standing puzzle despite a large body of work.⁷ I argue that the SA data support a locality-based analysis. The embedded agent is subject to locality for (Case)-licensing, and is separated from its licenser by a *phase* domain. \bar{A} -movement places them in a local configuration. The structure is schematized in (190), where the arc delineates the phase domain separating the higher licenser, i.e. the matrix Voice, from the licensee, i.e. the embedded agent.

⁷e.g. *French, Italian* (Kayne 1975, 1984; Rochette 1988); *Tagalog* (Richards 2001; Rackowski and Richards 2005); *Malagasy*, (Pearson 2001); *English* (Postal 1974, 1993; Pesetsky 1991; Bošković 1997; Rezac 2013, i.a.)

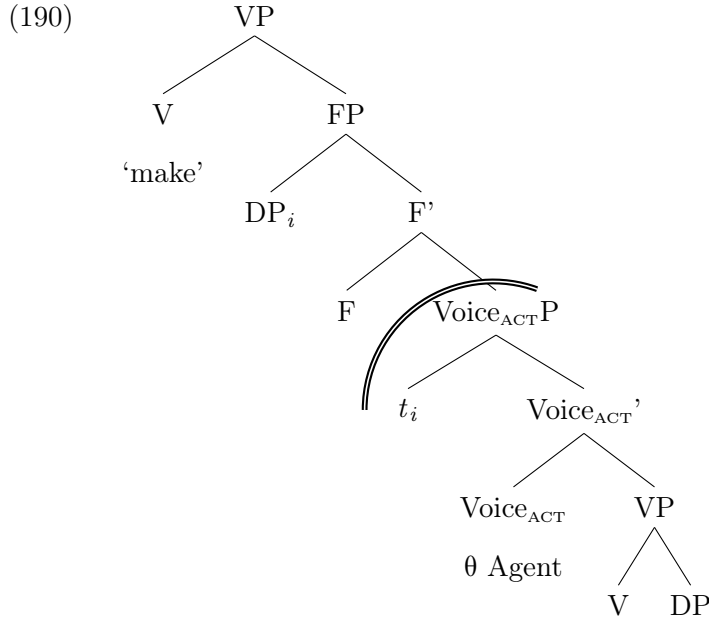

Overall, I demonstrate that ‘make’-causatives in Sason Arabic can embed three structures:

(191) passive VoiceP

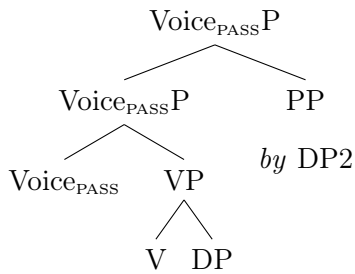

active VoiceP

(variable agent)

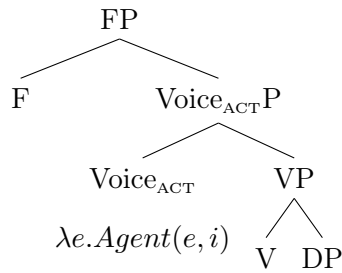

active VoiceP

(full DP agent)

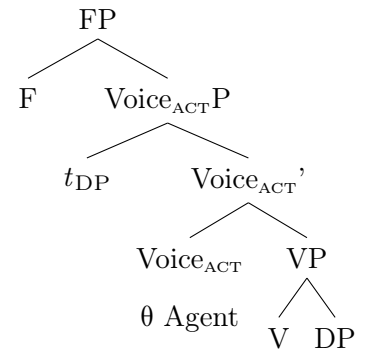

I first proceed with the investigation of the size of the structure embedded under ‘make’. I contend that ‘make’ embeds a reduced structure, specifically no AspP or higher projections, but a thematic VoiceP.

3.2.1 Size of the embedded structure

A variety of diagnostics demonstrate that ‘make’ does not embed AspP or higher projections (cf. *restructuring* of Wurmbrand 2001 et seq). Table 3.1 summarizes the diagnostics.

no CLLD, <i>wh</i> -phrase or complementizers to the right of ‘make’	→	*CP
no negation on the infinitive	→	*NegP
no distinct temporal modification or auxiliaries	→	*TP
no agreement or portmanteau Aspect+Voice morphology	→	*AspP
agent-oriented adverbs, comitatives, instruments, <i>by</i> -phrases	→	✓VoiceP
no stative predicates or unaccusatives		
independent manner adverbs	→	✓VP

Table 3.1: Size of ‘make’-causatives complement (v1)

Let us proceed in a top-down fashion to elaborate on diagnostics regarding the presence or absence of a projection.

Clitic Left Dislocation (CLLD) demonstrates that ‘make’ does not embed a full CP. Direct or indirect object arguments in Arabic may normally be CLLD-ed to a left-peripheral position in the CP domain, be it the matrix or embedded CP, (Benmamoun, 2000; Aoun et al., 2010), as in (192) (The CLLD-ed DP and the resumptive pronoun related to it are italicized).

- (192) a. *gaste* ams qari-tu-a
 newspaper.F yesterday read-1SG-it.F
 ‘The *newspaper*, I read *it* yesterday.’
- b. m-i-qbel le *gaste* ams qari-tu-a
 NEG-3M-accept that newspaper.F yesterday read-1SG-it.F
 ‘He doesn’t accept that *the newspaper*, I read *it* yesterday.’

However, (193) shows that such objects may not be CLLD-ed to the right of ‘make’, which indicates that the complement is not a full CP.

- (193) a. *ams dāde sa-tte *haṣiṣ* hazd-u.
 yesterday mom made-3F grass.M cut-it.M
 ‘Yesterday mom made *the grass* (someone) cut *it*.’
- b. *ams dāde sa-tte *gaste* qaru-a.
 yesterday mom made-3F newspaper.F read-it.F
 ‘Yesterday mom made *the newspaper* (someone) read *it*.’

Moreover, neither the finite complementizer *le* nor the subjunctive complementizer *te/ta* are

possible in SA ‘make’-causatives.

- (194) *ams dāde sa-tte le/te hazd haşış.
yesterday mom made-3F that/to cut grass
Intended: ‘Yesterday mom made that (someone) cuts the grass.’
OR ‘Yesterday mom made that (someone) cut._{subj} the grass.’

Moreover, negation is also disallowed on the infinitive, as shown in (195).

- (195) a. nana m1-n-isi xanni
we NEG-1PL-make sing
‘We don’t make anyone sing.’
b. *nana n-isi m1-xanni
we 1PL-make NEG-sing

The exact position of negation in the clause structure, i.e. whether it is located above TP or between TP and AspP, is not central to the discussion since the main point is to test its availability in ‘make’ causatives regardless of its exact position in the extended projection. In the literature on Arabic negation, some researchers have argued that negation is located between TP and AsP (e.g. Benmamoun 2000; Aoun et al. 2010), whereas others claim that it is above TP (e.g. Soltan 2007). An initial investigation of negation in SA suggests that the latter approach might be the correct one for SA negation, as evidenced by the relative position of negative morpheme with respect to the auxiliary, as in (196) (I leave the morpheme *kı* unglossed since its exact status is unclear to me).⁸

- (196) nana ma kınna kı-nayel şı
we NEG be.PAST.1PL ?-eat.IMPF food
‘We were not eating food.’

The examples in (197) show that the embedded clause cannot have distinct temporal modification, thus point to the absence of bi-clausality, and more precisely the absence of a TP layer (e.g. Wurmbrand 2001 et seq, Landau 2004; Legate 2014).

⁸though see Akkuş 2015 for some discussion, where I treated it as a low tense morpheme.

- (197) a. *ams aya sa hazd haşış lome.
yesterday village.lord made cut.INF grass today
‘Yesterday the village lord made (someone) cut the grass today.’
- b. *ams dāde sa-tte qaru gaste lome.
yesterday mom made-3F read.INF newspaper today
‘Yesterday mom made (someone) read the newspaper today.’

As expected, it is not possible to have a single temporal modifier in the embedded structure. Consider (198) with the adverb ‘tomorrow’, which cannot be associated with the matrix clause, and fails to be associated with the embedded clause as well.

- (198) *aya sa hazd haşış yade.
village.lord made cut.INF grass tomorrow.
‘The village lord made (someone) cut the grass tomorrow.’

With respect to the realization of aspect, as a common trait of Semitic languages, it is not easy to pinpoint a distinct aspect morpheme. To this end, for aspect in SA, building on the previous literature (e.g. Benmamoun 2000 for Arabic; Kramer 2014 for Amharic), Akkuş (2015, 17) suggests that “aspect is morphologically encoded by the position and phonological realization of the agreement marking on the verb”. According to this suggestion, we can track the aspect on the basis of the agreement marking on the verbal root, as such the absence of it can be interpreted as the lack of an Asp on the infinitivals. Relatedly, in SA the passive prefix is sensitive to aspect, as in (199), and is the portmanteau realization of Aspect+Voice heads, i.e. the fusion of Aspect and Voice heads, though the exact implementation is left aside.

- (199) a. potad *m-xısl-o* kıl-lom
clothes PASS.IMPF-wash.IMPF-3PL every-day
‘Clothes are washed every day.’
- b. potad *m-xasal-o* ams
clothes PASS.PFV-wash.PFV-3PL yesterday
‘Clothes were washed yesterday.’

The impossibility of the passive prefix on the infinitivals also indicates the lack of the aspect projection.

- (200) beaql ye isi **in-*/**in-*-addil musluq mī tamirci-ma
 unwise cop.3SG make PASS.IMPF/PASS.PFV-repair.INF tap by repairman-a
 hēdi.
 slow
 ‘It would be unwise to make the tap repaired by a slow repairman.’

The discussion thus far indicates that the structure ‘make’ embeds lacks CP, NegP, TP and AspP. In the next section, going bottom-up in the tree, I demonstrate that ‘make’ embeds a VP and an agentive VoiceP.

3.2.1.1 An embedded agentive VoiceP

In the literature, constructions similar to ‘make’ causatives have been proposed to embed a bare VP, and not higher projections (e.g. Swedish (Lundin, 2003), Hiaki (Harley, 2013), Hindi (Ramchand, 2006), Italian (Folli and Harley, 2007), Icelandic (Wood, 2011; Wood and Á. Sigurðsson, 2014)). This section first summarizes some arguments from the previous literature for the bare VP analysis. This is followed by the introduction of arguments for the presence of a thematic Voice in SA ‘make’ ICs, not just VP.

For instance, Folli and Harley (2007) propose that the properties of the two causative classes in Italian, *faire infinitif* (FI) and *faire par* (FP) depend on the nature of the complement of *fare*: FI embeds a *v*P, FP a nominalized VP. The syntactic and semantic characteristics of these complements account for well-known differences between FI and FP, including the previously untreated “obligation” requirement in FI, absent in FP. Despite the structural difference between the two classes, both lack the Voice layer in the embedded event.

Hiaki is another language which has been suggested to lack the relevant Voice projection. Harley (2013) notes that besides the *-tua* ‘direct’ causative, in which the Causee must be expressed, Hiaki also has a productive ‘indirect’ causative, *-tevo*, where the Causee is necessarily suppressed, as shown in (201).

- (201) Inepo Santoh-ta hitto-tevo-k
 I Santos-ACC treat.medically-CAUS.INDIR-PRF
 ‘I had Santos treated.’ (for a medical condition) (Harley, 2013, (33))

When suffixed with *-tevo*, an embedded verb receives a ‘passive’ or ‘impersonal’ reading, despite the absence of any passive or impersonal Voice morphology. Harley (2013) argues that the embedded subject is completely absent from the syntax, as evidenced by passivization facts. When a *-tevo* causative is passivized, the Causer is unexpressed and the object of the embedded verb becomes the derived subject.

- (202) Santoh hitto-tevo-wa-k
 Santos treat.medically-CAUS.INDIR-PASS-PRF
 ‘(Somebody) had Santos treated.’

(Lit: Santos was caused to be treated.) (Harley, 2013, (34))

Thus, the Causee - the embedded subject - is truly syntactically absent, as nothing intervenes between the embedded object and the matrix subject position (202). The morpheme *-tevo* selects as its complement a constituent which does not contain the external argument-selecting head, as in Folli and Harley’s (2007) treatment of *faire par* causatives, or Ramchand (2006) on Hindi indirect causatives. If *-tevo* has such a selectional restriction, the Causee argument will be absent, since the projection which introduces it will necessarily be absent.

This line of argument extends to indirect causatives in other, unrelated languages such as Turkish (e.g., Key 2013), where the theme of the embedded verb is promoted to become the grammatical subject of the clause when passivized. As seen in (203), the derived subject receives nominative case and agrees with the verb of the main clause. The causee is expressed as a DP bearing dative case and is not intervener for the raising of the embedded theme.

- (203) a. bütün çocuk-lar süt-ü iç-ti-ler.
 all child-PL milk-ACC drink-PST-3PL
 ‘All children drank the milk.’
- b. bütün çocuk-lar-a süt-ü iç-ir-di.
 all child-PL-DAT milk-ACC drink-CAUS-PST
 ‘(S/he) made all children drink the milk.’ (Çetinoğlu et al., 2008, 4a)
- c. süt bütün çocuk-lar-a iç-ir-il-di.
 milk all child-PL-DAT drink-CAUS-PASS-PST
 ‘The milk was made (by him/her) to be drunk by children.’
 (Çetinoğlu et al., 2008, 4b)

These examples have been used to argue for a bare VP analysis or at least the absence of a Voice layer in the embedded event in many languages. Before discussing the presence or absence of VoiceP in SA, I first establish that the clause is bi-eventive in SA, thus a VP layer is available in the complement structure. The possibility of independent manner adverbs, each modifying a different event given the right context, confirms this. (204) illustrates.

- (204) aya xıfep sa hazd haşış hēdi.
village.lord quickly made cut.INF grass slowly
‘The village lord quickly made (someone) cut the grass slowly.’

Drawing first on the line of work in Bruening (2013); Alexiadou et al. (2015),⁹ I argue that the embedded event contains at least a thematic Voice projection. The thematic Voice accounts for (i) the availability of instrument phrases modifying the embedded agent, (ii) agent-oriented adverbs associated with the embedded agent, (iii) agent-oriented comitatives, (iv) the requirement for the embedded event to have an external argument, (v) the lack of stative verbs in the embedded complement and (vi) the acceptability of certain agentive ‘by’-phrases.

3.2.1.1.1 Instrument Phrases Instrumentals are diagnostics for an external argument layer (i.e. a Voice layer). They tend to be banned from the same environments as ‘by’-phrases (Fillmore, 1968; Bruening, 2013; Alexiadou et al., 2015). For instance, in (205b) the instrument reading for ‘with hammers’ is not available in the anticausative/unaccusative, whereas it is available in the passive, (205a).

- (205) a. bina in-faşş-e mı işçiyad wara çakuçad.
apartment PASS-demolish-3F by employees with hammers
‘The apartment was demolished by the employees with hammers.’
b. *bina in-qalab-e mı rua wara çakuçad.
apartment INCH-fall.over-3F by itself with hammers
‘The apartment fell over by itself with hammers.’

⁹Alexiadou et al. (2015) is actually a culmination of a long line of work, going back at least to Alexiadou and Anagnostopoulou (2004), and worked out in detail in Schäfer (2008) – and even then building off of earlier literature. I take Alexiadou et al. (2015) to be representative of this line of work.

Instrumentals are also grammatical in ICs, which points to the presence of the embedded agent, (206).

- (206) a. aya sa hazd haşış wara mazgun-ma.
village.lord made.3M cut.INF grass with sickle-a
'The village lord had the grass cut with sickles.'
- b. dāde sa-tte ayet şurvan wara ibre.
mom made-3F sew.INF pants with needles
'Mom had the pants sewn with needles.'

These instrument phrases can modify the actions of the implicit agent. This suggests a Voice layer representing such an agent. Note that depending on the felicity of the context, instrument phrases are more saliently ambiguous with respect to whether they refer to the agent of causation or the implicit embedded agent, as in (207).

- (207) kemal sa buay sir beyt wara sope
Kemal made.3M paint do.INF house with stick
'Kemal, with the stick, had [someone paint the house].'
'Kemal had [someone paint the house with the stick].'

The main take-away point is that instrumental adverbs can modify the embedded, caused event.

3.2.1.1.2 Agent-oriented Adverbs Agent-oriented adverbs in SA provide another testing ground regarding the availability of an agent in the embedded verb phrase (Ernst 2001; Matsuoka 2013, i.a.). As such, these adverbs are compatible with passives, but not unaccusatives/anticausatives, as represented in (208).

- (208) a. bina in-faşş-e mı işçiyad wara diqqat.
apartment PASS-demolish-3F by employees with care
'The apartment was demolished by the employees carefully.'
- b. *bina in-qalab-e mı rua wara diqqat.
apartment INCH-fall.over-3F by itself with care
'The apartment fell over by itself carefully.'

These adverbs can modify the action of the embedded agent, as seen in (209).

- (209) a. bolum tı-si [mez sınavad le qabul wara diqqat].
 department 3F-make look.INF tests of acceptance with care
 ‘The department makes (someone) check acceptance tests carefully.’
- b. halq iril-lu le başbaqan i-si [farg eqonomī wara aql].
 public want-him that prime minister 3M-make handle.INF economy with mind
 ‘The public wants that the prime minister makes (someone) handle the economy wisely.’

Depending on the context, these adverbs may also be ambiguous in terms of whether they modify the action of the matrix agent or the embedded agent. This is illustrated in (210).

- (210) aya sa hazd haşış bı sabır.
 village.lord made cut.INF grass with patience
 ‘The village lord made [(someone) cut the grass patiently].’
 ‘The village lord, patiently, made [(someone) cut the grass].’

3.2.1.1.3 Agent-oriented comitatives Agent-oriented comitatives indicate that the agent had help from the comitative in performing the event. They tend to pattern with instrument phrases and agent-oriented adverbs in picking out a Voice layer (Bruening, 2013; Alexiadou et al., 2015). As such, the comitative reading that is available in (211a) is lost with unaccusatives, as in (211b).

- (211) a. bina in-faşş-e wara sırray fi-ya
 apartment PASS-demolish-3F with burglar in-it.F
 ‘The apartment was demolished with the burglar inside.’
 (the burglar was helping with the demolishing from inside)
- b. bina in-qalab-e wara sırray fi-ya
 apartment INCH-fall over-3F with burglar in-it.F
 ‘The apartment fell over with the burglar inside.’
 (the burglar was inside when the building fell over)

Turning to ‘make’-causatives, we see that the comitative reading is also available in this construction.

- (212) a. kemal sa [hamıl mase wara hasan].
 Kemal made carry.INF table with Hasan
 ‘Kemal made (someone) carry the table with Hasan.’
 (Hasan helped carry the table)
- b. kemal sa [faş bina wara işçiyad].
 Kemal made demolish.INF apartment with employees
 ‘Kemal made (someone) demolish the building with the employees.’
 (the employees helped demolish the building)

The ambiguity of modification regarding the embedded or matrix clause is observed with comitatives as well.

- (213) aya sa hazd haşış wara cinarad.
 village.lord made cut.INF grass with neighbors
 ‘The village lord made [(someone) cut the grass with the neighbors].’
 ‘The village lord, with the neighbors, made [(someone) cut the grass].’

Thus far, we have seen that instrumentals, agent-oriented adverbs and comitatives point to the presence of a thematic Voice layer in the embedded event.

3.2.1.1.4 The requirement for embedded external argument Another diagnostic to demonstrate that the embedded verb phrase is a VoiceP, and not just a VP, involves a constraint on the embedded external argument: as seen thus far, the embedded verb phrase may be transitive or unergative, as shown in (214).

- (214) a. ab-i sa patk fo com
 father-my made.3M jump.INF over fence
 ‘My father made (someone) jump over the fence.’
- b. ams cinar-i sa faqz imbala sabap
 yesterday neighbor-my made run.INF without reason
 ‘Yesterday my neighbor made (someone) run for no reason.’¹⁰

On the other hand, unaccusative verbs are disallowed.

¹⁰There might be a schwa between the consonant sequence *qz* of *faqz* ‘run’. I gloss over phonetic details throughout unless they matter to the discussion.

- (215) a. *kemal sa var mi mardivan-ad
 Kemal made.3M fall.INF from stair-PL
 Intended: ‘Kemal made (someone) fall from the stairs.’
- b. *ab-i sa mēt mi bert
 father-my made.3M die.INF from cold
 Intended: ‘My father made (someone) die from cold.’

I interpret this asymmetry as an argument that the complement of ‘make’ must contain a thematic VoiceP.

3.2.1.1.5 Stative predicates In addition to the impossibility of unaccusative predicates in the embedded verb phrase, the restriction on stative verbs is another indication of the presence of a Voice layer. Stative predicates are not embeddable under the ‘make’ causative, as illustrated in (218).¹¹

- (218) a. *recel sa bazu kileb.
 man made fear.INF dogs
 ‘The man made (someone) fear dogs.’
- b. *recel sa ifi-llu araba-ma.
 man made exist-him car-a
 ‘The man made (someone) have a car.’

Following Harley (1995); Folli and Harley (2007, 215), I assume that stative verbs such as ‘have’, ‘fear’ do not take an external argument, similar to unaccusative predicates. I interpret this as the absence of a (thematic) Voice layer with such predicates, and hence their incompatibility with ‘make’ causatives. Note that in SA, such verbs are not passivizable.

¹¹Possession in SA is expressed with the expletive *ifi* (also available in Palestinian Arabic, e.g. Boneh and Sichel 2010) and a clitic.

- (216) ifi-nna araba-ma
 EXPL-us car-a
 ‘We have a car.’

The absence of the clitic leads to a purely existential reading.

- (217) ifi araba-ma
 EXPL car-a
 ‘There is a car.’

- (219) a. kemal ibze kileb-na
 Kemal fear.3M dogs-our
 ‘Kemal fears our dogs.’¹²
- b. *kileb-na in-bızo mi kemal
 dogs-our PASS-fear.3PL by kemal
 ‘Our dogs are feared by Kemal.’

Note that in addition to ‘fear’, other subject experiencer verbs such as ‘enjoy’, ‘understand’ are also ungrammatical in this construction.

- (220) a. *recel sa zavk raqs
 man made enjoy.INF dance
 ‘The man made (someone) enjoy the dance.’
- b. *recel sa samu masala
 man made understand.INF issue
 ‘The man made (someone) understand the issue.’

Furthermore, instrumentals mapped as external arguments are not felicitous. This is illustrated in (221).

- (221) a. #recel sa fadu babe
 man made open.INF door
 NO: ‘The man made some key open the door.’
 YES: ‘The man made someone open the door.’
- b. #recel sa qas tiffaye
 man made cut/slice.INF apple
 NO: ‘The man made some knife cut the apple.’
 YES: ‘The man made someone cut the apple.’

Verbs such as ‘rot’, ‘stink’ are not embeddable under ‘make’ causatives. The ungrammaticality could be because the verb ‘rot’ patterns as unaccusative, and the embedded agent is inanimate.

¹²Some speakers use the form ‘fear from dogs’ with ‘fear’ selecting a PP, rather than ‘fear dogs’. Such speakers also do not allow passivization. Both arguments are presumably introduced vP-internally, though I leave this issue aside.

- (222) *kemal sa pat mı uç le nahar
 man made rot.INF from face of sun
 ‘Kemal made rot because of the sun.’

On the other hand, it should be noted that although the embedded agent of ‘make’ causatives is most saliently interpreted as human, there is no such a restriction. As such, an animal interpretation is also possible given with a salient context.

- (223) kemal sa zaray sinnor-ad
 man made sting.INF cat-PL
 ‘Kemal had the cats stung.’ (OK: by some bees)¹³

I interpret this asymmetry as an argument that the complement of ‘make’ must contain a thematic VoiceP.

3.2.1.1.6 Agentive ‘by’-phrases ‘By’-phrases are also grammatical with some restrictions on their acceptability. Most felicitous examples are when the DP embedded under *by* is indefinite, as in (224a). Note that it is introduced in the same way external arguments are in canonical passives (cf. 240), i.e. with the preposition *mi* ‘by, from’. Definite ‘by’-phrases lead to ungrammaticality, as in (224b).¹⁴

- (224) a. (?)kemal sa xassil potad mı mara-ma pir-e.
 kemal made.3M wash.INF clothes by woman-a old-F
 ‘Kemal had the clothes washed by some old woman.’

¹³When presented with this sentence, a consultant in fact said: “If Kemal is evil and forces some bees somehow, this is possible.”

¹⁴The definiteness restriction on ‘by’-phrases has been commonly noticed for a variety of constructions and languages. For instance, Sigurðsson and Wood (2018) report a very similar restriction for Icelandic ‘let’-causatives to that of SA ICs. Kaiser and Vihman (2006, 132) note that in Estonian, generalized, unspecific groups are possible as ‘by’-phrases whereas specific, identifiable individuals are not.

There are other constructions with similar restrictions on ‘by’-phrases. Pitteroff (2014) mentions that German impersonal passives have similar constraints. Ability adjectives in English also exhibit this restriction.

- (i) a. *This is doable by the child.
 b. This is doable even by a child.

A similar constraint is observed even in English *tough*-construction, in that the more indefinite, generic the ‘by’-phrase is, the better it is. I leave aside why this restriction is widely available across constructions and languages, including SA ICs. Although see e.g. Ultra-Massuet 2013; Alexiadou 2018 for some discussion in the context of *-able* adjectives.

- b. sa-tte addil beyt (*mı usta)
 made-3F build.INF house (*by the.builder)
 ‘She had the house built by the builder.’

Indefinite ‘by’-phrases further improve when they are “heavy” (heaviness reminiscent of ‘heavy-NP shift’), as illustrated in (225).

- (225) iri-nni a-si addil beyt mı usta-ma ande (le) y-are şine
 want-me 1SG-make build.INF house by builder-a who (that) 3M-know what
 y-addel
 3M-do
 ‘I want to have the house built by a builder who knows what they are doing.’

The best examples are with instances in which an impersonal or generic interpretation is available.

- (226) beaql ye isi addil musluq mı tamirci-ma hēdi.
 unwise cop.3SG make repair.INF tap by repairman-a slow
 ‘It would be unwise to make the tap repaired by a slow repairman.’

The possibility of ‘by’-phrases as in (224-226) suggests that there is a Voice layer, introducing an agent role that can be modified/identified by the ‘by’-phrases.

To summarize, we have thus far seen six diagnostics arguing for the presence of a thematic Voice layer: (i) the availability of instrument phrases modifying the embedded agent, (ii) the agent-oriented adverbs associated with the embedded agent, (iii) agent-oriented comitatives, (iv) the requirement for the embedded event to have an external argument, (v) lack of stative verbs in the embedded complement, and (vi) the acceptability of certain ‘by’-phrases.

These diagnostics show that ‘make’ causatives in SA differ from similar constructions in embedding a structure up to VoiceP. I also demonstrate that active Voice, but not passive Voice is dominated by a focus projection, FP.

3.2.1.2 FP above active VoiceP

As a first step, I establish that as a general property of the language, in SA with active VoiceP, a contrastively-focussed constituent can raise either to the sentence-initial position

or to a low position, FP, between the auxiliary and the participle (focus is indicated via small caps, and FP is represented in a box).¹⁵ The focussed element cannot remain *in-situ*, thus contrastive focus indicates movement to a higher position. As an illustration, the grammatical object in (227) is contrastively focussed in (228).

(227) kemal ku i-xsel şurvan.
 kemal be.3M 3M-wash pants
 ‘Kemal is washing the pants.’

(228) (ŞURVAN) kemal (*ŞURVAN) ku (ŞURVAN) i-xsel (*ŞURVAN) (qawa lā).
 pants kemal pants be.3M pants 3M-wash pants shirt no
 ‘Kemal is washing the pants, (not the shirt).’

On the other hand, with passive VoiceP, the low focus position is not projected, (229), as shown by the ungrammaticality of the focused element appearing in the low position. Therefore, in SA active VoiceP is dominated by FP, whereas passive VoiceP is not.

(229) a. kınna n-adi kemal kitab.
 be.IPFV.1PL 1PL-give.IPFV Kemal book
 ‘We are giving Kemal the book.’

b. kemal ku in-y-adi kitab.
 Kemal be.IPFV.3M PASS.IPFV-3M-give.IPFV book
 ‘Kemal is being given the book.’

c. (KITAB) kemal (*KITAB) ku (*KITAB) in-y-adi (*KITAB)
 book Kemal book-a be.3M book PASS.IPFV-3M-give book
 (gaste lā).
 magazine no
 ‘Kemal is being given the book, (not the magazine).’

We observe that the contrast between active versus passive VoiceP regarding the availability of FP also holds in ‘make’-causatives besides finite (root or embedded) clauses. When the embedded clause is active (indicated by the absence of a ‘by’-phrase; see section 3.2.2 for the discussion), a focussed constituent can appear sentence initially as well as in a lower

¹⁵Ouwayda and Shlonsky (2016) notes a similar low-focus position for Lebanese Arabic, and Jarrah and Abusalim (2020) for Jordanian Arabic.

position between ‘make’ and ‘infinitive’, indicating that FP is available embedded under ‘make’, (230). Similar to the situation in root clauses, the focus element may not remain *in-situ*.

- (230) (ŞURVAN) kemal (*ŞURVAN) ku (ŞURVAN) i-si (ŞURVAN) xassil
 pants Kemal pants be.3M pants 3M-make pants wash.INF
 (*ŞURVAN), (qawa lā).
 pants shirt no
 ‘Kemal is making someone wash the pants, (not the shirt).’

Likewise, with an embedded passive Voice (indicated by the presence of a ‘by’-phrase), FP is unavailable, (231).

- (231) (ŞURVAN) kemal (*ŞURVAN) ku (ŞURVAN) i-si (*ŞURVAN) xassil
 pants Kemal pants be.3M pants 3M-make pants wash.INF
 (*ŞURVAN) mī recel-ma pir, (balgife lā).
 pants by man-a old.M pillow no
 ‘Kemal had the pants (not the pillow) washed by some old man.’

To summarize, ‘make’-causatives involve a reduced structure, precisely no AspP or higher projections, but a thematic VoiceP. Moreover, active, but not passive VoiceP is dominated by FP. These properties are summarized in Table 3.2.

no CLLD, <i>wh</i> -phrase or complementizers to the right of ‘make’	→ *CP
no negation on the infinitive	→ *NegP
no distinct temporal modification or auxiliaries	→ *TP
no agreement or portmanteau Aspect+Voice morphology	→ *AspP
low focus position	→ ✓FP
agent-oriented adverbs, comitatives, instruments, <i>by</i> -phrases	→ ✓VoiceP
no stative predicates or unaccusatives	
independent manner adverbs	→ ✓VP

Table 3.2: Size of ‘make’-causatives complement (final)

Building on the discussion thus far, the next section establishes that this thematic VoiceP manifests an active-passive alternation. However, before proceeding with that discussion, I investigate another alternative, i.e. ‘make’ embeds a nominalized complement (which is

what Folli and Harley 2007 suggests for *faire par* in Romance causatives). I contend that this analysis cannot carry over to ‘make’ causatives in SA.

3.2.1.3 An alternative: ‘make’ embeds a nominalized complement

I use two diagnostics to demonstrate that ‘make’ does not take a nominal complement, but a verbal one. First, Folli and Harley (2007, 19) draw the generalization that if a *v* takes a nominal complement (including for *faire infinitif* vs *faire par* (Kayne 1975)), it requires an animate agentive external argument - thus disallows causers such as *rage*, *generosity* or *famine*. Therefore, they are disallowed in FP *fare* (but not in FI *fare*, which embeds a regular vP). This is illustrated in (232a) for Italian, and in (232b) for French.

(232) a. Italian

*La rabbia fece rompere il tavolo da Gianni.
the rage made break the table by Gianni

‘Rage made Gianni break the table.’ (Folli and Harley 2007, 27)

b. French

*La famine a fait manger des rats par les habitants de la ville.
the famine has made eat of.the rats by the inhabitants of the city

‘The famine made the inhabitants of the city eat rats.’ (Folli and Harley 2007, 28)

Applying this generalization to ‘make’-causatives in SA, (233) shows that ‘make’ does not take a nominal complement. Causers such as *earthquake* and *fear* are licit in this construction.

(233) a. zelzele sa-tte maş buyud-en
earthquake made-3F leave.INF houses-their

‘The earthquake made (some people) leave their houses.’

b. bazu isi adu qararad kotti-n mı calabma insanad
fear 3M.make give.INF decisions bad-PL by some people

‘Fear makes bad decisions made by some people.’

Note also the contrast between (234a) and (234b). In (234a), ‘wash’ is used in an argument position, is nominalized, requires the use of the preposition *le* ‘of’, and has a different morphological form. This gerundial form is identical to cognate objects in the language. This form is not possible for the ‘make’ causative construction.

- (234) a. xasil *(le) potad in-yaddel fi sake m1 r1cel
 wash.GRND of clothes PASS-do in lake by men
 ‘Washing of clothes is done in the lake by men.’¹⁶
- b. aya sa xassil / *xasil *(le) potad
 village.lord made wash.INF / wash.GRND of clothes
 ‘The village lord made (someone) wash the clothes.’

These two tests show that ‘make’ does not embed a nominalized complement.

3.2.2 An embedded VoiceP with active-passive alternation

This section deals with the status of the thematic Voice in the complement of the causative ‘make’. Given the discussion in the previous section, one possible approach is to consider analyzing the embedded Voice head as passive, as in Pitteroff’s (2015) analysis of *let*-middles constructions (*sich-lassen*) in German (also see Bhatt and Embick 2017 for Hindi-Urdu). However, I argue that the embedded Voice is not exclusively passive, instead manifests an active-passive alternation despite the absence of a morphological reflex of this alternation.¹⁷

The generalization we reach is that in the presence of a ‘by’-phrase the embedded VoiceP is passive, while in its absence the VoiceP is active. The arguments for this active-passive alternation are (i) the (im)possibility of A-moving the embedded object when the matrix ‘make’ is passivized, (ii) sluicing, and (iii) nonpassivizable idioms.

¹⁶Cf. the garden-variety use of gerundials, (234). The loss of the *i* vowel in ‘wash’ is phonologically conditioned.

- (234) *potad, xallis-tu xasl-en*
 clothes finished-1SG wash.GRND-PL
 ‘Clothes, I finished washing them.’

¹⁷Harley (2017b) notes that languages indeed have many constructions which have syntactic and semantic properties of passives, yet lack any overt morphological exponent of passivization, especially in embedded contexts. See Pitteroff (2014, 2015) for a very similar view.

3.2.2.1 (Impersonal) Passive

One reason to think that the embedded construction shows an active-passive alternation comes from the passivization of the matrix ‘make’. When the embedded clause contains a ‘by’-phrase, it behaves like a canonical passive, in that the embedded verb does not license the object, instead behaves as licensed by the matrix ‘make’. Therefore, when ‘make’ is passivized,¹⁸ the embedded theme raises to grammatical subject position and shows verbal agreement. Consider (235a-235b). Raising is not possible without a ‘by’-phrase, as illustrated in (235c).

- (235) a. kemal sa [xassil potad mɪ mara-ma pir-e].
kemal made.3M [wash.INF clothes by woman-a old-F]
‘Kemal had the clothes washed by some old woman.’
- b. potad in-so [xassil _ mɪ mara-ma pir-e].
clothes PASS.PFV-made.3PL [wash.INF _ by woman-a old-F]
‘Clothes were made to be washed by some old woman.’
- c. *potad in-so [xassil _]
clothes PASS.PFV-made.3PL [wash.INF _]
Intended: ‘Clothes were made to be washed.’

We can represent (235b) as (236), in which the embedded clause has a ‘by’-phrase, indicating its passive nature, and the embedded theme raises to grammatical subject (as such it manifests subject-verb agreement) when the matrix ‘make’ is also passivized.

¹⁸Cf. German ‘let’-middles are similar to SA ‘make’-causatives in terms of not having a passive morphology. However, German does not allow ‘let’ to passivize, whereas the passivization of ‘make’ is possible in SA; therefore ‘make’ is a lexical verb in SA, rather than a functional verb as has been argued for German (Pitteroff 2015, 120).

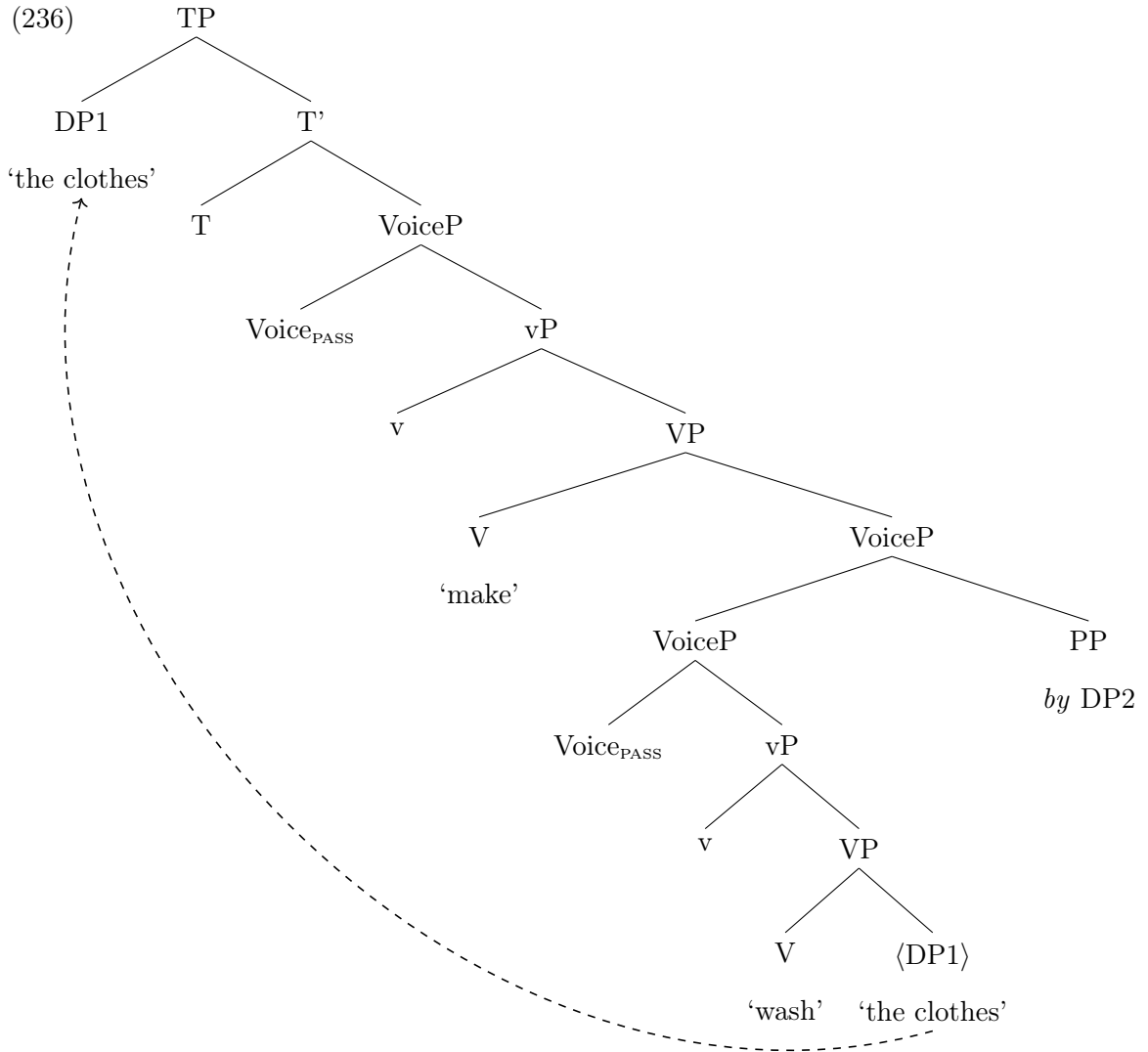

Without a ‘by’-phrase, the embedded clause behaves like a canonical active, with the embedded object behaving as though licensed by embedded verb.

The embedded theme remains a grammatical object even when ‘make’ is passivized. Passivization of ‘make’, when the embedded clause lacks a ‘by’-phrase, results in an impersonal passive. The embedded theme does not raise to the subject position. No argument is associated with the grammatical subject position, as such ‘make’ is realized with the default 3rd singular masculine agreement. Consider (237)-(238).

- (237) *m-sa* [addil *bina*].
 PASS.PFV-made.3M [build.INF building.F]
 ‘Someone_{*i*} made someone_{*k*} build the building.’
- (238) a. *kemal sa xassil potad-na.*
kemal made.3M wash.INF clothes-our
 ‘Kemal made (someone) wash our clothes.’
- b. *lora acepma m-sa xassil potad-na*
then somehow PASS-made wash.INF clothes-our
 ‘Then somehow someone_{*i*} made (someone_{*k*}) wash our clothes.’

Crucially, under the active embedded analysis, this is expected. Without a ‘by’-phrase, the embedded clause behaves as active, even when the matrix ‘make’ is passivized.

SA does indeed independently have impersonal passives, as in (239).

- (239) a. *lora m-sa dans (mi misafir-ad).*
then PASS-did dance (by guest-PL)
 ‘Then it was danced (by the guests).’
- b. *m-zak asriye kull-u.*
PASS-laughed evening.M all-M
 ‘It was laughed the whole evening.’

To summarize, the passivization of the matrix ‘make’ allows us to demonstrate the presence of two possible embedded structures, one active and one passive, despite the absence of a morphological reflex of this alternation. Without a ‘by’-phrase, the embedded structure behaves as active, as such the embedded theme is licensed by the embedded verb, and remains a grammatical object even when ‘make’ is passivized (see section 3.2.3). Yet, the presence of a ‘by’-phrase necessarily leads to a passive clause, in that the embedded verb cannot license the embedded theme, which seems to be licensed by the matrix ‘make’. Accordingly, when ‘make’ is also passivized, the theme raises to become the grammatical subject.

Some remarks are in order regarding the obligatoriness of ‘by’-phrases for a passive structure in ‘make’ causatives, since this contrasts with garden-variety clausal passives in which ‘by’-phrases are optional, (240).

- (240) *ala cam (mı kemal) in-qaraf b1-l-qasti.*
 this glass (by Kemal) PASS-broke.3M with-the-intention
 ‘This glass was broken (by Kemal) deliberately.’ (Yakut, 2013, 7; with slight modifications)

Another instance the obligatoriness of a ‘by’-phrase is reported by Ingason (2016) for Icelandic, where in the caused-experiencer construction, the causing event can be expressed as a ‘by’-phrase adjunct, but this adjunct cannot be omitted. This is illustrated in (241).

- (241) *Stelpunum var skemmtun *(af dansinum).*
 girls.the.DAT was entertainment.NOM *(by dance.the)
 ‘The girls were entertained by the dancing.’ (Ingason, 2016, (145))

Again in Icelandic, ‘by’-phrases in short passives are never obligatory, as illustrated in (242).

- (242) *Stelpunum var skemmt (af Jóni).*
 girls.the.DAT was entertained (by John)
 ‘The girls were entertained by John.’ (Ingason, 2016, (147))

Given the generalization regarding the obligatoriness of the ‘by’-phrase, we are faced with four different constructions in SA. Regular active and regular passive occur in full clauses, while implicit active and embedded passive with a ‘by’-phrase occur embedded under ‘make’. I attribute this to selectional properties of ‘make’, as such when ‘make’ selects for an active Voice, it selects for the denotation without a specifier, and when it selects for a passive Voice, it selects for the version with a ‘by’-phrase (see Chapter 4 in which I argue Turkish causatives have the opposite pattern and allow only the existentially closed denotation. This crosslinguistic variation is indeed predicted by an analysis of passive with two semantic denotations). Noting that any explanation must remain at a speculative level at this point, I believe in fact at the conceptual level, it is possible to categorize the four constructions in a way that makes a more symmetric division for the denotations of passive and active. Semantically, the passive is traditionally associated with two semantic denotations, one for the version with implicit agent, and the other one with the ‘by’-phrase (see e.g. Bruening 2013; Legate 2014; Legate et al. 2020). On the other hand, the agent in the active is

associated with a single syntactic and semantic denotation, i.e. the presence of a projected argument in Spec, VoiceP. Although it still does not explain the obligatoriness of ‘by’-phrases, we can say that in fact the SA facts allow us to have two semantic denotations for the agent in the active as well (which is what this dissertation essentially argues for; see section 3.2.4.2), thus making it parallel to the passive. As such, the active could have a denotation for a version with a specifier and another denotation for the version without a specifier (cf. Wood 2015).

It should also be noted that it may not be a coincidence that both in SA and Icelandic, the obligatoriness of the ‘by’-phrase is observed in causative constructions. Ingason (2016) attributes the obligatoriness of the ‘by’-phrase to the causative semantics in the Icelandic construction that he examines, yet does not elaborate on it. The different behavior from matrix passives also supports the view that the obligatoriness may be tied to the causation somehow. It could be that the selection requirements of ‘make’, the size of the complement clause (and possibly other factors) play a role in this obligatoriness. Thus, one could attempt to employ either a semantic or syntactic explanation. As mentioned by Ingason, it is also worth exploring if ‘by’-phrases are syntactic arguments rather than adjuncts. Relatedly, the possibility of a selected adjunct is also worth testing given that selected adjuncts have come up at a few points in the literature, e.g. “Mary worded the letter *(carefully)”. It is also possible that languages tend to have more constructions with obligatory ‘by’-phrases, apart from the Icelandic and Sason Arabic examples, yet these might have hitherto escaped attention. Further studies on less studied Voice constructions in general, rather than short passives might reveal a pattern, and give us enough empirical base to draw a theoretical claim from.

3.2.2.2 Sluicing

Another reason to think that the embedded complement manifests an active-passive alternation comes from ‘sluicing’. While VP ellipsis may in some cases allow voice mismatching, sluicing does not (Merchant, 2013), as shown in (243).

(243) VP ellipsis

- a. You may want to install that now if it isn't already ~~installed~~.
- b. This system can be used by anyone who wants to ~~use it~~.

(244) Sluicing

- a. *Joe was murdered, but we don't know who ~~murdered him~~.
- b. *Someone murdered Joe, but we don't know by who ~~he was murdered~~. (adapted from Merchant 2013)

Sason Arabic is no exception to this generalization. VP ellipsis allows voice mismatch, as indicated in (245), whereas sluicing disallows voice mismatch, which is shown in (246).

(245) VP ellipsis

- a. kemal kul çax i-xsel potad ta bad ma kınno.
Kemal every time 3M-wash clothes if yet not are
'Kemal washes the clothes every time if they are not already.'
- b. ala bilgisayar itix in-fide mı ande le irillu.
this.M computer can PASS-open by who that wants
'This computer can be turned on by anyone who wants to.'

(246) sluicing

- a. sadqe le boş samaq in-qafal-o, hama mı-arafe *(mı) ande
believed.3F that many fish PASS-caught-3PL but NEG-knew.3F *(by) who
'She believed many fish to have been caught, but she didn't know *(by) who.'
- b. in-sadax mı misafir-ad le mara-ma qafal-e boş samaq,
PASS.PFV-believed.3M by guest-PL that woman-a caught-3F many fish
hama mı-y-arf-o *(mı) ande
but NEG-3M-know-PL *(by) who
'It was believed by the guests that some woman caught many fish, but they don't know *(by) who.'

Turning to 'make' causatives, we observe that the embedded verb patterns as active for sluicing in the absence of 'by'-phrase, as in (247).

- (247) mafya sa qadil mara-du, hama m-ore (*m₁) ande
 mafia made murder.INF wife-his but NEG-know.1SG (*by) who
 ‘The mafia leader made (someone) murder his wife, but I don’t know (*by) who’

It is indeed possible to have different interpretations depending on whether sluicing targets the main clause or the embedded clause, as shown in (248). In (248a), the remnant ‘who’ indicates that the sluice is active and it can target the caused event ‘build’ in the complement of ‘make’, diagnosing ‘build’ as active. In (248b), the remnant ‘by who’ indicates that the sluice is passive, and it can only target the matrix clause, an impersonal passive, not the caused event ‘build’, again diagnosing ‘build’ as active.

- (248) a. in-sa addil beyt, hama m-ore ande
 PASS-made build.INF house but NEG-know.1SG who
 ‘It was made (someone) build the house, but I don’t know who’
 YES: who built the house
 NOT: who made somebody build the house
- b. in-sa addil beyt, hama m-ore m₁ ande
 PASS-made build.INF house but NEG-know.1SG by who
 ‘It was made (someone) build the house, but I don’t know by who’
 YES: who made somebody build the house
 NOT: who built the house

When a ‘by’-phrase is present, the embedded verb now patterns as passive for sluicing.

- (249) kemal sa xassil potad m₁ mara-ma pir-e, hama m-ore tam *(m₁)
 Kemal made wash clothes by woman-a old-F, but NEG-know.1SG exactly *(by)
 ande.
 who
 ‘Kemal made the clothes be washed by an old woman, but I don’t know exactly
 *(by) who.’

- (250) potad (m₁ imm-i) in-so xassil m₁ nes-ma, hama
 clothes (by mother-my) PASS-made.3PL wash.INF by person-a but
 m-ore *(m₁) ande
 NEG-know.1SG *(by) who
 ‘Clothes were made (by my mother) to be washed by a person, but I don’t know

*(by) who.’

Thus, sluicing provides another strong piece of evidence that the embedded VoiceP in ‘make’ causatives shows an active-passive alternation.

3.2.2.3 Nonpassivizable idioms

SA has a class of non-passivizable idioms, as in (251). These idioms are another test for active-passive alternation (cf. Kayne 1975; Folli and Harley 2007).

- (251) a. kemal qaraf fayz le şeytan
Kemal broke.3M leg of devil
‘Kemal finally got lucky.’ (lit. broke the devil’s leg)
- b. fayz le şeytan in-qaraf mı kemal
leg of devil PASS-broke.3M by Kemal
‘The devil’s leg was broken by Kemal.’
‘*Kemal finally got lucky.’

These idioms may occur in ‘make’ causatives only in the absence of ‘by’-phrases, supporting the claim that without a ‘by’-phrase, it is active. This also demonstrates that the restriction against unaccusatives is not semantic. The predicate “getting lucky” is not agentive, but the verb “break” has an external argument.¹⁹

- (252) a. kul çax tı-si qarf fayz le şeytan
every time 3F-make break.INF leg of devil
‘Every time she makes (someone) get lucky.’

¹⁹ Note that the selectional requirement is for a thematic voiceP not for the DP to be interpreted as agentive, and idioms are exactly where these two can be teased apart. When compared with the properties of, for instance, geminate causatives in Section 3.3, this view finds further support. Both types of causatives may embed an event such as *wash the clothes*. However, ‘make’ causatives require the embedded agent to have the Initiator role, whereas gemination requires the Causee theta-role (as such, the impossibility of agent-oriented instrumentals, comitatives or adverbs, as well as the choice of a different preposition; to be discussed later in this chapter).

One option is to follow an analysis along the lines of Folli and Harley’s (2007) flavors of *v* (building on Hale and Keyser 1993), which varies in interpretation across verb categories, as such *v*_{BECOME} yields inchoative reading, and *v*_{DO} derives transitive clauses. An implementation along these lines would capture the difference ‘make’ causatives and gemination exhibits despite embedding the same event. This would be achieved by indexing the requirement on the selecting head, as such ‘make’ selects for an agentive VoiceP, whereas the causativizing head in geminates selects for an ApplP (or applicative VoiceP in Legate’s (2014) terms). Note that this does not explain the obligatory implicitness of the embedded agent in ‘make’ causatives as opposed to overtness of the causee in gemination, which probably has another reason. Still, it would serve as a way of capturing several contrasting properties.

- b. kul çax tı-si qarf fayz le şeytan mı oranci-ma azimli
 every time 3F-make break.INF leg of devil by student-a determined
 ‘Every time she has the devil’s leg broken by a determined student.’

NOT: a determined student finally gets lucky.

Idioms of this sort contrast with passivizable idioms, illustrated in (253).

- (253) a. kemal hatarax ro-i
 Kemal burned heart-my
 ‘Kemal broke my heart.’
 Lit: ‘Kemal burned my heart.’
- b. ro-i m-hatarax mı kemal
 heart-my PASS-burned by Kemal
 ‘My heart was broken by Kemal.’

Unlike non-passivizable idioms, which require the absence of ‘by’-phrases, such idioms impose no restriction, as shown in (254).

- (254) a. sa-tte harx ro le kemal
 made-3F burn.INF heart of Kemal
 ‘She made (someone) break Kemal’s heart.’
- b. sa-tte harx ro le kemal mı nes-ma gize kotti
 made-3F burn.INF heart of Kemal by person-a such bad
 ‘She had Kemal’s heart broken by such a bad person.’

Following Harley and Stone (2013), Harley (2017b), I assume that non-passivizable idioms are impossible in (252b) since they require an active Voice to be present. On the other hand, the passivizable idioms are possible with or without a ‘by’-phrase, since the former option indicates an active Voice, whereas the latter a passive Voice.

3.2.2.4 Interim Summary

All of the evidence combined supports the proposal that syntactically, the embedded construction exhibits an active-passive alternation in SA ‘make’ causatives.

First, we find evidence that there is at least a thematic Voice layer (the availability of ‘by’-phrases, instrument phrases, agent-oriented adverbs, external argument restriction,

etc.). Then we find a variety of indications that there is an active-passive Voice projection in the complement of ‘make’. In addition to the passive being marked via obligatory ‘by’-phrases, several diagnostics converge on this alternation: (i) the fact that ‘make’ can be passivized, and that the object is not promoted unless the embedded structure itself is passivized (ii) sluicing, (iii) nonpassivizable idioms. As such, this construction varies from similar constructions from other languages, some of which mentioned above. The diagnostics for the active-passive alternation are summarized in Table 3.3.

	embedded structure	
	with <i>by</i> -phrase	without <i>by</i> -phrase
theme raising under matrix passive	✓	*
non-passivizable idioms	*	✓
passivizable idioms	✓	✓
sluicing remnant	by whom	who

Table 3.3: Active-passive embedded VoiceP

In the next section, I demonstrate that the embedded theme remains as the grammatical object in the active even when ‘make’ is passivized and the embedded verb is active.

3.2.3 Theme as the grammatical object

This section shows that the theme argument is a grammatical object independently of whether ‘make’ is active or passive. In other words, the theme shows properties of a grammatical object of a transitive construction rather than those of a derived subject, i.e., a grammatical subject of passives. Therefore, the discussion shows that ‘make’ may embed an active VoiceP with a grammatical object licensed by the embedded verb. Given the standard view about active (transitive) clauses (cf. Burzio 1986; Chomsky 1995b, i.a.), this implies that the embedded agent is projected despite being implicit, which I argue to be incorrect in section 3.2.4.²⁰

²⁰The relevance of this discussion to Burzio’s (1986) generalization comes from the standard assumption about how transitivity arises. It is traditionally assumed that transitivity arises through a Voice functional head (Kratzer 1996) (or the projection of little *v* of Chomsky (1995b), relying on work by Larson (1988) and Hale and Keyser (1993)), which (a) introduces an external argument (in its specifier), and (b) forms an abstract Case (or Agree) relation with an object. As such these two properties form Burzio’s (1986) generalization. The SA ‘make’ causatives also bear on the issue of whether Case licensing of a grammatical object is possible for VoiceP and not dependent on the projection of a specifier, be it in the form of a

3.2.3.1 Definiteness effect

The first piece of evidence comes from the definiteness effect. In SA, indefinite subjects tend to occur postverbally with the possibility of appearing preverbally as well. On the other hand, definite subjects are strongly preferred in preverbal position. Consider (255).²¹

- (255) a. ca zıyer-*(ma).
 came.3M child-*(a)
 ‘A/*?The child came.’
- b. zıyer-(ma) ca.
 child-(a) came.3M
 ‘A/The child came.’

As the grammatical subject, a low theme in the passive also exhibits definiteness effects, as illustrated in (256).

- (256) a. m-adal beyt-*(ma)
 PASS-built.3M house-*(a)
 ‘A / *?The house was built.’
- b. Beyt-(ma) m-adal.
 house-(a) PASS-built.3M
 ‘A/The house was built’

However, the low embedded theme in the complement of ‘make’ does not, as in (257), regardless of whether ‘make’ is active or passive.

- (257) a. sa addil beyt-(ma)
 made.3M build.INF house-(a)
 ‘He made (someone) build a/the house.’
- b. m-sa addil beyt-(ma)
 PASS-made build.INF house-(a)
 ‘It was made (someone) build a/the house.’

This shows that the embedded theme shows properties of a grammatical object of a transitive construction rather than those of a derived subject.

grammatical subject, e.g. Burzio’s (1986) generalization, (also see Marantz 1991; Woolford 2003; McFadden 2004), or as ϕ -features, i.e., the weak implicit argument, in Spec, VoiceP (Legate 2014).

²¹Note this pattern is unlike other Arabic varieties that allow post-verbal definite subjects.

3.2.3.2 Clitic Left-Dislocation (CLLD)

The second argument that indicates that the embedded theme is the grammatical object comes from the fact that it can undergo CLLD.

- (258) *haşış*, ams aya sa hazd-*u*.
grass yesterday village.lord made cut-it.M
'The grass, yesterday the village lord made (someone) cut it.'

As discussed in section 3.2.1, direct or indirect object arguments in Arabic varieties may be CLLD-ed. However, the grammatical subject cannot be CLLD-ed. This holds both for the thematic subjects, (259a), as well as the underlying objects raised to become the subject via passivization, (259b).

- (259) a. *kemal* qara-(**u*) gaste.
Kemal.M read.PFV-him newspaper.F
'Kemal, he read the newspaper.'
- b. *kemal* in-qadal-(**u*).
Kemal.M PASS-kill.PFV-him
'Kemal, he was killed.'

In (260), lack of agreement on the main verb indicates that it is an impersonal passive. The embedded clause is active, indicated by the lack of 'by'-phrases. The embedded theme can undergo CLLD, and thus behaves as a grammatical object.

- (260) *kitabad*, in-sa qaru-*en*.
books PASS-made read.INF-them
'The books, it was made (by someone) that someone read them.'

When the matrix verb is passive, and there is a 'by'-phrase associated with the embedded verb, the theme cannot undergo CLLD.

- (261) gaste in-satt-e-(**a*) qaru-(**a*) mī nes-ma tawwil.
newspaper.F PASS-make.F-it.F read.INF-it.F by person-a tall
'The newspaper, it was made [read by a tall person].'

- (262) pot-ad (m1 imm-i) m-sa-o-(*en) xassil-(*en) m1 nes-ma
 clothes-PL (by mother-my) PASS-make-3PL-them wash.INF-them by person-a
 ‘Clothes were made (by my mother) washed by a person.’

These diagnostics demonstrate that the embedded theme functions as the grammatical object, licensed by the embedded verb in the embedded active VoiceP. Assuming the standard view about active (transitive) clauses (cf. Burzio (1986); Chomsky (1995b), i.a.), the straightforward expectation is that the embedded agent is projected despite being implicit. The next section deals with the syntactic and semantic status of the null implicit agent.

3.2.4 Embedded agent as a free variable

In light of the above discussion, we can deal with the question of whether the implicit argument is syntactically projected or not in the active complement of ‘make’ given that the embedded agent is null. I contend that the embedded agent is not projected in the embedded Spec,VoiceP, but is present as a free variable on the Voice head (in the sense of Heim 1982). I also discuss the possibility of the implicit argument being projected as a ϕ P (e.g. Legate 2014; Landau 2010) and contend against it on the basis of recent work.

3.2.4.1 The implicit embedded agent and projection

The diagnostics in section 3.2.1.1 identify the presence of a thematic Voice, but do not necessarily entail the syntactic projection of such arguments. For instance, Bhatt and Pancheva (2006, 2017) conclude that in some cases implicit arguments seem to be syntactically active, but that there is no good evidence to suggest that they are syntactically projected (see also Williams 1985; Roeper 1987; Landau 2010; Legate 2014; Collins 2018a,b; Šereikaitė 2020 for the discussion of implicit arguments).

This section investigates (i) anaphor binding, (ii) depictive licensing and (iii) scope in ‘make’ causatives, demonstrating that the embedded agent is not projected.

3.2.4.1.1 Reflexives, reciprocals and depictives Sason Arabic exhibits a contrast between active and passive clauses in terms of the binding of reflexives and reciprocals.

However, I first establish that in SA neither reflexive, (263), nor reciprocal, (264), are logophoric using typical logophoric contexts (see Sells 1987 i.a.).

(263) reflexive²²

- a. xattiye Kemal_i. *abu-n_i m-it-bex şorbiye mışa ro-u_i.
 poor Kemal father-3SG.POSS NEG-3M-cook soup for self-3M
 ‘Poor Kemal_i. His father won’t cook soup for himself_i.’
- b. *Kemal_i i-bze le abu-n m-it-bex şorbiye mışa ro-u_i.
 Kemal 3M-fear that father-3SG.POSS NEG-3M-cook soup for self-3M
 ‘Kemal_i is afraid that his_i father won’t cook soup for himself_i.’

(264) reciprocal²³

- a. xattiyin [Leyla u Kemal]_i. *abu-en_i m-it-bıx-o şorbiye mışa
 poor Leyla and Kemal father-3PL.POSS NEG-3-cook-PL soup for
 baz-en_i.
 each.other-3PL
 ‘Poor [Leyla u Kemal]_i. Their father won’t cook soup for each other_i.’
- b. *zıyar_i i-bz-o le abu-en m-it-bıx-o şorbiye mışa
 children 3-fear-PL that father-3PL.POSS NEG-3-cook-PL soup for
 baz-en_i.
 each.other-PL
 ‘The children_i is afraid that their_i fathers won’t cook soup for each other_i.’

Reflexives in SA need a projected binder, thus are not licensed in passives. Consider (265).

- (265) a. zıyar_i adl-o odav (mişa roen_i).
 children did-3PL homework for themselves
 ‘The children did the homework (for themselves).’
- b. odav in-adal (*mişa roen/rou).
 homework PASS-did.3M for themselves/himself
 ‘The homework was done for (*themselves/himself).’

Example (266) demonstrates that the reflexive is not licensed by the embedded agent in the active complement of ‘make’ causatives, either.²⁴

²²These are grammatical on the irrelevant interpretations ‘His father_k won’t cook soup for himself_k’ and ‘Kemal is afraid that his father_k won’t cook soup for himself_k’.

²³These are grammatical on the irrelevant interpretations ‘Their fathers_k won’t cook soup for each other_k’ and ‘The children are afraid that their fathers_k won’t cook soup for each other_k’.

²⁴Note also that the reflexive in SA is not subject-oriented, thus the ungrammaticality is not due to

- (266) *iya_i sa-tte addil_k odav (*mı̄ṣa rou_k / roen_k).*
 she made-3F do.INF homework for himself / themselves
 ‘She_i made (some person_k / people_k) do the homework for himself_k / themselves_k.’

Reciprocals pattern like reflexives in needing a projected binder; therefore, they are also not licensed in passives.

- (267) a. *calabma insan-ad_i bas-o baz-en_i*
 some human-PL kissed-3PL each other-3PL
 ‘Some people_i kissed each other_i.’
 b. **baz-en m-bas-(o).*
 each other-3PL PASS-kissed-(3PL)
 ‘Each other was/were kissed.’

The reciprocal is also not licensed by the embedded agent in the active complement of ‘make’ causatives. This is illustrated in (268).

- (268) **iya satte bās_k baz-en_k.*
 she made kiss.INF each other-3PL
 ‘She made (some people) kiss each other.’

Depictives also require projection of their licensors in SA: accordingly, they are not allowed in passives, as shown in (269).

- (269) a. *nes-ma_i amal araba (sarxoş_i).*
 person-a drove car (drunk)
 ‘Someone_i drove the car drunk_i.’
 b. *araba m-amal-e (??sarxoş)*
 car.F PASS-drove-F (??drunk)
 ‘The car was driven drunk.’

Similar to reflexives and reciprocals, depictives also are not licensed by the embedded agent in the active complement of ‘make’ causatives.

a ban against a potential oblique antecedent, as in (i) (thanks to David Pesetsky and Kyle Johnson for independently bringing this to my attention.)

- (i) *varrit-u kemal_i rou_i fi ayne*
 showed-1SG Kemal himself in mirror
 ‘I showed Kemal himself in the mirror.’

- (270) a. $nana_i$ $mi-ni-si$ $amil_k$ $araba$ ($sarxos_{i/*k}$)
 we NEG-1PL-make drive car drunk
 ‘We_i don’t let (anyone_k) drive the car drunk_{i/*k}.’
- b. $nana_i$ $si-nna$ $karu_k$ $xanni$ ($sarxos_{i/*k}$).
 we made-1PL write.INF song drunk
 ‘We_i made (someone_k) compose the song drunk_{i/*k}.’

These diagnostics rule out a *pro*-dropped argument analysis for the null embedded agent, as such rules out a structure of the sort in (271), according to which the null agent is both semantically and syntactically present.

(271) **pro*

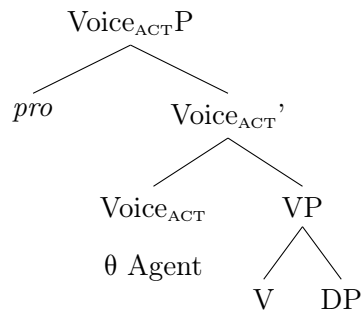

The other alternative is to suggest that the embedded agent is interpreted existentially, i.e. it is semantically present, but not syntactically. This option could presumably have two different structures: (i) semantically and syntactically passive, as in (272), or (ii) semantically passive but syntactically active, (273)?²⁵ We have seen already in Section 3.2.2 that (272) cannot be the structure for ‘make’-causatives since ‘make’-causatives requires a ‘by’-phrase for passive structure.

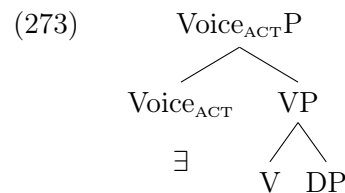
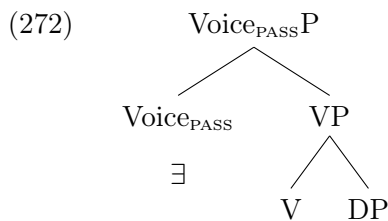

In either case, the meaning would be paraphrase-able to something like “There is someone

²⁵e.g. Šereikaitė (2018) for *active existential* in Lithuanian.

who performs the event.” I demonstrate that the alternative fails to capture various patterns.

3.2.4.1.2 Scope The scopal interaction with negation provides another piece of evidence that the null embedded agent is not solely a PF-matter, but that it has interpretive results. I should note that this test is not perfect since, as shown in section 3.2.1, negation cannot be in the embedded clause. Still, if there were a null projected agent we might expect it to be able to raise (e.g. QR at LF above negation). Therefore, it is still worth discussing.

Example (274) demonstrates that in cases where the embedded agent is null, it necessarily takes scope under negation.

(274) nana m₁-n-isi xanni
we NEG-1PL-make sing.INF
‘We don’t make sing.’

YES: We don’t make anyone sing.

NO: We don’t make a certain person sing.

neg > some, *some > neg

The infelicitousness of the sentence in (275) confirms the scopal judgments in (274). This is because whenever the first sentence is uttered truthfully, there is no person that will sing in the wedding, thus the follow-up sentence conflicts with the meaning of the antecedent discourse.

(275) sima-tu le m₁-isi xanni fi dawe, # hama m-ore ande.
heard-1SG that NEG-make.3SG sing.INF in wedding but NEG-1SG.know who
‘I have heard that he won’t make anyone sing in the wedding, # but I don’t know who.’

So far, the evidence points towards a view that the agent is not projected despite the active VoiceP, thus SA ICs resemble the active existentials in Lithuanian. Šereikaitė (2018) demonstrates that in active existentials, exemplified in (276), the voice is active, the theme remains a grammatical object, and yet the embedded agent is not projected (see Šereikaitė 2018 for the diagnostics).

(276) *Active Existential*, (Lithuanian)

Valių kvieč-ia j dekanatą
Valius.ACC invite-PRS.3 to dean's.office.ACC
'Someone is inviting Valius to the dean's office.'

(Kibort and Maskaliūnienė 2016:251, cited in Šereikaitė 2018)

Šereikaitė (2018, 2020) argues that the presence of a thematic Voice head is sufficient to count as active and license accusative case of the grammatical object in certain root clauses in Lithuanian. The embedded agent is not projected, but existentially closed at the Voice level, thus the label *active existential*.

The next section, however, shows 'make'-causatives differ from the active existential in that unlike the Lithuanian active existentials, in SA 'make' causatives, pronouns can be licensed by the null embedded agent. Therefore, the analysis for active existentials along the lines of (273) cannot carry over to SA. Instead the next section posits that the agent is realized as a free variable, rather than being subject to existential closure.

3.2.4.2 Proposal: Embedded agent as a free variable

Similar to reflexives, reciprocals and depictives, pronouns cannot be anchored to the implicit agent of passives. In other words, canonical passives do not allow the pronoun to be bound by the implicit agent, thus force a disjoint-reference interpretation, as in (277).

(277) aya m-ada tirab-en.
village.lord PASS-gave land-their
'The village lord was given their lands' (not by the owners of the land)

Implicit arguments of passives cannot antecede pronouns occurring subsequently in the clause or in a subsequent clause (see e.g. Koenig and Mauner 2000).²⁶ Thus, the implicit agents of passives, marked as *e* in (278) (e.g. *by a builder* in (278a) or *by a mother* in (278b)) are not licit antecedents.

²⁶Unless this is achieved via the accommodation process through the use of the indefinite *they* (e.g. Lewis 1979; Koenig and Mauner 2000).

- (278) a. kul mara beyt le ande in-adal e_j ad-1-llu $_{*j}$ dırem.
 every woman house of who PASS-built gave-3F-him money
 ‘Every woman whose house was built e_j gave him $_{*j}$ money.’
- b. #ta ibın-ma in-cib fi dınye e_j fi şart-ad kotti-yin, doxtor-ad
 if baby.boy-a PASS-brought in world in condition-PL bad-PL doctor-PL
 yardım is-o-ll-a $_j$ ta le baş tı-sir $_j$.
 help do-3PL-her so that good 3F-become
 ‘If a baby boy is delivered in unsafe conditions e_j , the doctors help her $_j$ heal quickly’

Pronouns corresponding to the embedded agent, however, are possible in the ‘make’ causative construction, as illustrated in (279).

- (279) a. ammo $_i$ sa sen $_k$ mazgun-u $_{i/k}$.
 uncle made sharpen.INF sickle-his
 ‘Uncle $_i$ made (someone $_k$) sharpen his $_{i/k}$ sickle.’
- b. gızbe-ye le kemal $_i$ ma-sa xassil $_k$ qamis-a $_{*i/k}$ fi saqe.
 lie-3.COP that Kemal NEG-made wash.INF skirt-her in river
 ‘It is a lie that Kemal $_i$ didn’t let anyone $_k$ wash her $_{*i/k}$ skirt in the river.’
- c. aya $_i$ sa bayu $_k$ tırab-u $_{i/k}/-(?)a_{*i/k}$.
 village.lord made sell.INF land-his/-her
 ‘The village lord $_i$ made (someone $_k$) sell his $_{i/k}/$ her $_{*i/k}$ land.’

Furthermore, the implicit agent of passive cannot pick out (i.e. be co-indexed with) a previously established entity in the discourse.

- (280) kemal adaş nes-ma $_i$. #lora in-bas e_i .
 Kemal saw.3M person-a then PASS-kissed
 ‘Kemal saw [a person] $_i$. #He was kissed e_i ’

On the other hand, the null embedded agent in ‘make’-causatives can refer back to an established entity (as long as the identity of that individual is unknown).

- (281) kemal adaş nes-ma $_i$. aya sa hazd $_i$ haşış.
 Kemal saw.3M person-a village.lord made cut grass
 ‘Kemal saw [a person] $_i$. The landlord made him $_i$ /her $_i$ cut the grass.’

The patterns are summarized in Table 3.4: in the active anaphors, depictives and pronouns are licensed, whereas in the passive none is. On the other hand, the ‘make’ causative exhibits a mixed behavior: while the anaphors and depictives are not licensed, pronouns are.

	anaphors & depictives	pronouns
active	✓	✓
<i>make</i> active complement	*	✓
passive	*	*

Table 3.4: Binding properties in Voice types

Examples in (279) suggest that a potential analysis along the lines of Šereikaitė (2018), in which the embedded agent is existentially closed, like in the passive, cannot carry over to SA since that analysis would rule out the licensing of pronouns as well. Accordingly, I posit (following Heim 1982) that the embedded agent is present as a free variable, generated in the Voice head itself,²⁷ and bound by Voice-level or text-level Existential Closure. This approach treats indefinites as non-quantificational, and as such the indefinite is like a free variable x_i , with no quantificational force of its own. The indefinite gets bound in one of two ways: (i) either by being under the scope of an (unselective) quantifier in the sentence, e.g. *if*-clauses, adverbs, negation, or (ii) in their absence by an operation of existential closure, which puts an implicit unselective \exists on texts. This view, i.e. the dynamic analysis of indefinites, has been suggested to account for instances of e.g. (282) as well as ‘cross-sentential anaphora’ and ‘donkey sentences’, illustrated in (283) and (284), respectively.

- (282) *boş karrad, ta sinnor-ma i-vir m1 fistox, irce say i-bqa.*
 most times if cat-a 3M-fall from roof still alive 3M-remain
 ‘Usually, if a cat falls from the roof, it still survives.’

²⁷The mechanism suggested here indeed has precedents in the literature, e.g. Wood (2015, ch. 4), who allows the introduction of a thematic role, i.e. an open semantic position, for figure reflexives with $p\{\}$ in Icelandic, without having a specifier position. The proposal here shares that view, with the added ‘free variable’ interpretation of this semantic role in order to capture and its parallelism with indefinite DPs and the definiteness restriction.

Wood (2015, ch. 4) speculates that the figure role can be introduced without a specifier since it is within the extended projection of the verb with a slight ‘look ahead’ issue. Note that this explanation would extend to SA ‘make’ causatives to a certain extent, since we can indeed treat Voice as being in the extended projection of the verb, but this would not suffice to explain its restriction to ‘make’ causatives. Similar to the issue raised by Wood’s work, we would have a look ahead issue as well.

Paraphrase: ‘Most cats survive if they fall from the roof.’ (adapted from Heim 1982, 123)

(283) mara-ma daxal-e cua. lora *pro* qad-e fo kursi-ma.
 woman-a entered-3F inside then sat-3F on chair-a
 ‘A woman entered. She sat on a chair.’

(284) kul çifçi ande le y-axez hamar-ma_i i-habb-u_i
 every farmer who that 3M-buy donkey-a 3M-love-M.CL
 ‘Every farmer who buys [a donkey]_i loves it_i.’

Examples (285) - (287) demonstrate that the same considerations apply to ‘make’ causatives. We see that the free variable in the ‘make’ causative can antecede a following pronoun. This constitutes a contrast with the implicit passive agent in (278). I take this contrast as corroborating evidence that the implicit arguments in the causative construction differ from the implicit agents of passives. Whereas the latter requires an accommodation process in order to serve as an antecedent, the former does not.

(285) boş karrad, ta aya i-si hazd haşış, i-hazed.
 most times if village.lord 3M-makes cut.INF grass 3M-cut
 ‘Usually, if the village lord makes (someone) cut the grass, he cuts it.’

Paraphrase: ‘Most people cut the grass if the village lord makes them (do so).’

(286) ta le aya i-si addil beyt-ma, lazim-ye le
 if that village.lord 3M-make build house-a necessary-COP.3SG that
 i-xals-u-n xıfef
 3-finish-PL-M.CL quickly
 ‘If the village lord makes (some people) build a house, it is necessary that they finish it quickly.’

(287) aya sa addil beyt. Boş bacarikli kan, şa gize beyt
 village.lord made.3M build.INF house much talented was.3M therefore house
 koys ye sa
 beautiful be.3M now
 ‘The village lord made build the house. He (the builder) was very talented, thus the house is beautiful now.’

It is also possible to compare the behavior of the null embedded agent with that of implicit indefinite objects in languages like English.

- (288) a. Mary has already eaten.
b. John baked yesterday.
c. Mike is drinking on the front porch.

These notional, but null objects are standardly taken not be grammatically represented; instead, that object is only provided for pragmatically, or to be only semantically present via existential closure that applies to the lexical verb, i.e. V_{\exists} (see e.g. Carlson 2006; Groefsema 1995; Hall 2009; Bruening 2020).²⁸ This comparison further supports the view that the null embedded agent in ‘make’-causatives exhibits behavior that is quite distinct from that of an existentially closed one.

First, similar to the implicit agent of passives, an implicit indefinite object cannot pick out a previously established entity in the discourse. Note that in (290), the implicit object of the verb ‘eat’ cannot be interpreted as though it picked its referent from the preceding context, the way a definite would (examples from Martí 2011).

(289) There was [a loaf of bread]_i in the kitchen, but Mary didn’t eat e_{*i}

(290) A: John is eating a cookie!

B: *Oh, I’d love to eat <the cookie> too!

Again similar to implicit agents of passives, the null indefinite object cannot antecede pronouns.

(291) John baked yesterday. #It was delicious.

Moreover, the implicit indefinite object cannot be bound by higher quantificational elements, the way pronouns can (Martí 2011). Compare (292) and (293).

²⁸Martí 2011 argues that these implicit indefinite objects are the null counterparts of incorporated objects. Leaving aside the plausibility of this analysis, note that incorporated objects behave identical to existentially closed for the diagnostics we are concerned with. For instance, an (pseudo)-incorporated object cannot antecede a subsequent pronoun. Though see Bruening 2020 for some considerations against such an incorporation analysis.

It is also worth noting that not all implicit objects are a homogeneous category.

(292) Whenever John cooks mushrooms, Sally never eats them.

(293) Whenever John cooks mushrooms, Sally never eats.

These examples further corroborate the view that the null agent in ‘make’-causatives does not behave like it is existentially closed, therefore it differs from the implicit agent of passive or the implicit indefinite objects.²⁹

The embedded agent in ‘make’-causatives patterns like an overt indefinite, thus semantically equivalent to it. They both can be under the scope of an unselective quantifier, behave identically for discourse anaphora and ‘donkey sentences’. The two, however, differ in terms of anaphor licensing: whereas an overt indefinite can bind an anaphor (or license a secondary predicate; cf. (269a) versus (270a)), the embedded agent of ‘make’ causatives may not. Consider (294).

- (294) a. *recel-ma_i qadal rou_i*
man-a killed himself
‘A/some man killed himself.’
- b. *aya_i sa_k qadıl rou_{i/*k}*
village.lord made kill himself
‘The village lord made somebody kill himself.’

Accordingly, I propose that the implicit embedded agent is present not as a DP (as would be as in (295b)), but as a free variable, x_i , on the Voice head, as in (295a), and can be bound by Voice level or discourse-level Existential Closure (Heim, 1982).³⁰

(295) a. *null indefinite*

²⁹The implicit indefinite objects cannot license depictives. In this respect, they pattern like the null agent in ‘make’-causatives.

- (i) John ate (??raw).
(ii) John baked (??wonderful).

³⁰Note that the denotation is not strictly identical to that of Heim (1982) who takes an indefinite to be a proposition with a variable free in it. Also, Heim uses the subscript notation e.g. \exists_1 . See Heim (1982, 166-167) for its interpretation.

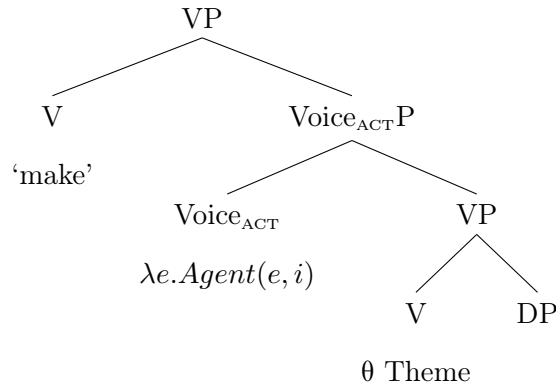

b. *overt indefinite*

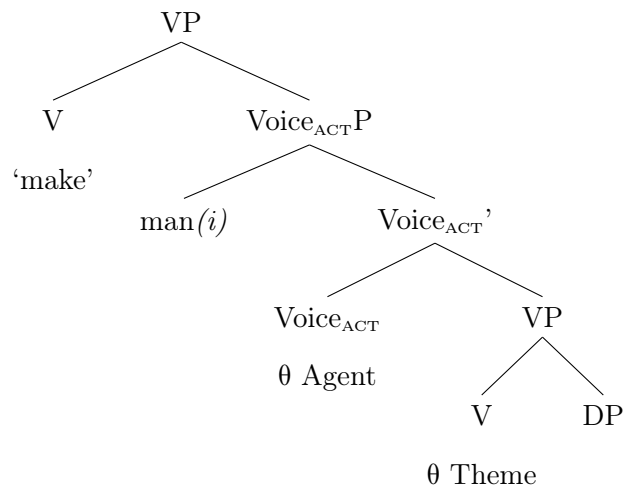

Existential Closure at the Voice-level explains cases in which the free variable takes scope under negation. The external θ -role is introduced by a functional head Voice; the active matrix Voice selects for a DP specifier; using the feature [\bullet D \bullet] (see Müller 2010). The semantic derivation is provided in (296).

(296)

$\lambda e.wash(e) \ \& \ AG(e, i) \ \& \ TH(clothes, e)$

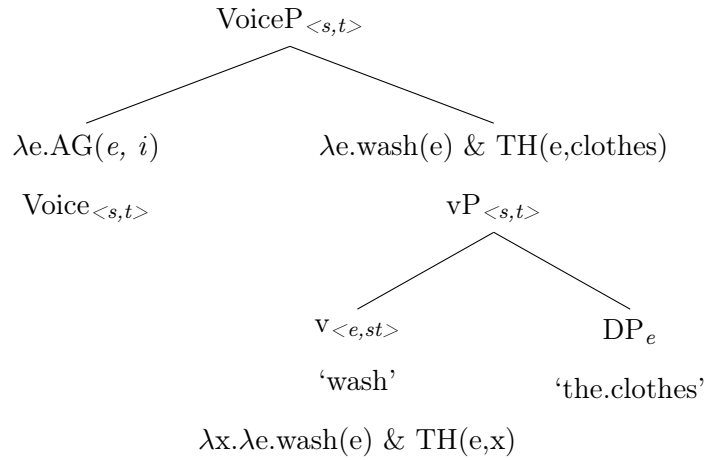

The core idea then is that pronouns (more precisely the variable they introduce) can be licensed by virtue of being co-indexed with another variable (in this case, the agent variable on Voice head) and being bound by the same operator.³¹ This can be roughly sketched as (297), based on Heim (1982).³²

Note that the pronoun variable that is not co-indexed gets reference from context.

³¹The facts in this section demonstrate that the implicit arguments do not form a uniform class, thus reinforces the view in Bhatt and Pancheva (2006, 2017); Landau (2010). A point of departure from Landau’s (2010:359, 378) model is that Landau treats the implicit agents of passives as Weak implicit arguments (WIA), which lack a [D] feature, thus should presumably have referential “flexibility”. As such, his model would equate the implicit agents of ‘make’ causatives and those of passives, both under the category of WIA.

However, it turns out that the properties Landau attributes to implicit agents of passives are exhibited by the implicit agents of ‘make’ causatives in SA, and not by the implicit agents of passives. Therefore, SA allows us to pinpoint two kinds of implicit arguments, yet indicating that the free variable property is associated with ‘make’ causatives, and not passives.

Moreover, as noted above, semantically an overt indefinite and the free variable of ‘make’ causatives are equivalent. They can introduce new discourse markers to which, for instance, a pronoun in the following sentence can refer. They also satisfy one of a main predicate’s arguments, it specifically being the embedded agent for ‘make’ causatives. Thus, there is not a difference of referential flexibility between the two as Landau draws between Strong implicit arguments and Weak implicit arguments. Accordingly, given the lack of evidence for the bare free variable being projected into a syntactic position, I place it on Voice head.

³²It is possible to ask what other heads are able to have such free variable realization in languages? This question would make typological predictions, and as far as I can tell, would depend on various, sometimes language-internal, factors. For instance, in SA the status of the embedded agent is dependent on the Voice being selected by the matrix verb ‘make’ (see fn. 19). As such we can expect a similar phenomenon in languages with a verb that has similar selectional requirements. Moreover, we can also expect Applicative head, i.e. a Causee θ -role, to be present as a free variable as long as the language in question permits this option. For instance, SA does not allow Appl, but it is possible to find a language that would.

(297)

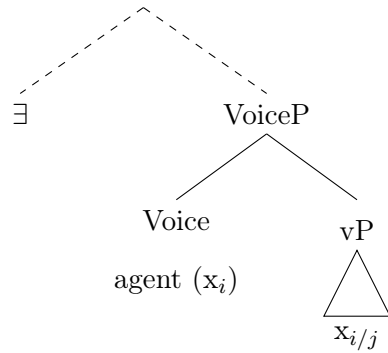

In the case of anaphors, although they are also semantically variables, they are subject to a further restriction. They are not licensed by \exists (same restriction applies to depictives as well), and require a fully projected licenser.

On the other hand, I adopt the analysis of passives from Chapter 2 (following Chomsky 2000, Legate 2014), and take the passive to be a subtype of the Voice head itself. Syntactically, the $\text{Voice}_{\text{PASS}}$ head introduces the external θ -role, but does not syntactically project this argument into its specifier. It is therefore compatible with a ‘by’-phrase adjunct, which optionally adjoins to VoiceP to specify the thematic subject.

Semantically, the passive would need to allow the external θ -role to be satisfied by the ‘by’-phrase, when present, and to otherwise be interpreted existentially (e.g. Bach 1980; Keenan 1985; Williams 1987; Parsons 1990; Bruening 2013; Alexiadou et al. 2015; Reed 2018). I therefore take it that $\text{Voice}_{\text{PASS}}$ has two associated semantic denotations (see also Bruening 2013; Alexiadou et al. 2015; Legate 2014; Legate et al. 2020). In the first one, which does not combine with a ‘by’-phrase, the initiator is existentially bound on the $\text{Voice}_{\text{PASS}}$ head. Note that \exists is necessarily internal to Voice^0 , thus cannot bind elements outside Voice , as shown in (298).

(298) $\lambda e. \exists x. \text{AGENT}(x, e)$

In the second semantic denotation, $\text{Voice}_{\text{PASS}}$ leaves the initiator position open, i.e. $\lambda e. \lambda x. \text{AGENT}(x, e)$, to be accessed by the ‘by’-phrase. On the other hand, in the passive complements of ‘make’ in SA (and in the ‘caused experiencers’ in Icelandic), only the second

denotation is available, as such the initiator is saturated by the ‘by’-phrase. This property of passives can be summarized in the table below.

	Passive	
	\exists	‘by’-phrase
canonical	✓	✓
‘make’ causatives in SA Icelandic ‘caused experiencer’	*	✓
??	✓	*

The table demonstrates that canonical passives usually exhibit both semantic denotations; whereas ‘make’-causatives in SA and Icelandic caused experiencers allow only one of the denotations, i.e. the one with the ‘by’-phrase. It is conceivable that there may be languages with constructions which manifest the opposite behavior, and only allow the denotation without a ‘by’-phrase. In Chapter 4, I argue that Turkish causatives fill the gap in this table, and that they are compatible only with existential closure, but not ‘by’-phrases.

3.2.4.3 An alternative analysis: ϕ P

In this section, I look at an alternative analysis of the implicit agent, in which it is realized as a ϕ P (Legate 2014) in Spec,VoiceP. Potentially this analysis could be tested against the control facts and the (abstract) accusative case on the embedded theme. In principle, it would also explain why the embedded theme does not raise to become the grammatical subject in examples such as (235c), repeated here as (299), in which presumably the embedded theme argument illicitly raises over the higher embedded implicit agent.

- (299) *potad m-so xassil
 clothes PASS-made.3PL wash.INF
Intended: ‘Clothes were made to be washed.’

On the basis of recent work, I contend that neither implicit control nor accusative case on the embedded theme require the syntactic projection of an implicit argument.

The first one concerns implicit control. It is indeed possible to embed both attitude and non-attitude control verbs under ‘make’, as in (300). As a background, similar to Hebrew,

control is into a finite complement in SA. They pass the obligatory *de se* reading and absence of the complementizer diagnostics, which are two of the hallmarks of control.³³

- (300) a. mafya sa qabul_i [PRO_i i-xtel hasm-u]
 mafia made accept.INF 3M-murder enemy-his
 ‘The mafia leader made someone agree to murder his enemy’
- b. mafya sa hawwal_i [PRO_i i-xtel hasm-u]
 mafia made try.INF 3M-murder enemy-his
 ‘The mafia leader made someone try to murder his enemy’

The question is whether being a controller necessarily entails syntactic projection. Some researchers have responded positively to this question. For instance, Landau (2010) in his classification of implicit arguments suggests that both SIAs and WIAs, which also include the passive agent, are visible as controller, therefore they should be syntactically projected. However, this conclusion has been challenged (e.g. Bhatt and Pancheva 2006, 2017) and argued against (van Urk, 2013; Pitteroff and Schäfer, 2019). For instance, similar to the tests discussed earlier (e.g. licensing of ‘by’-phrases, agent-oriented modifiers), Bhatt and Pancheva (2006, 2017) argue that the ‘control into purpose clauses’ test also does not necessitate the syntactic projection of an implicit external argument, including that of passives. Note also that, Landau’s (2010) main argument for the syntactic projection of implicit arguments (compared to leaving them syntactically unrepresented) is based on the observation that implicit arguments can function as the controller in partial-control contexts and the assumption that this type of control can only be treated in the syntax. However, as discussed in Pitteroff and Schäfer (2019), this argument contains two potential confounds: first, Landau develops his argument on the basis of implicit experiencers of adjectives. But since, for principled reasons, this argument cannot be applied to implicit agents of passives, the question of whether implicit agents of passives also license partial control remains open. Secondly, Pearson (2013, 2016) has recently shown that a purely semantic analysis of partial control is, in fact, possible. As such, the possibility of control cannot be taken to entail the

³³With the caveat that attitude verbs e.g. *promise*, *plan*, *accept* in SA allow overt subjects in their complements, unlike non-attitude predicates. I leave this for future work. See also Li 2020 for a similar contrast in Mandarin.

syntactic projection of the controller.

Whether we see any syntactic imports of a potential ϕ P for (300) is the important question. The presence of the (abstract) accusative Case on the embedded theme might be treated as an argument to this end. In fact, this is the main reason Legate (2014) postulates ϕ P, as such ϕ P makes it possible for the assignment of accusative case by a thematic Voice.³⁴ However, as mentioned earlier, Šereikaitė (2018, 2020) demonstrates that a thematic Voice head is sufficient for the assignment of accusative case, and thus the assignment of accusative case by Voice may vary independently from the selection of a specifier, be it a DP or ϕ P. Moreover, the necessity of a specifier position for case assignment of another DP (cf. Burzio’s (1986) Generalization or its alternative versions, e.g. Legate (2014) or Dependent Case Theory Marantz (1991); McFadden (2004); Preminger (2014)) is a theory-internal postulation. As such, alternative models of case assignment have been argued for. For instance, Clem (2019) and Akkuş (2020b) propose that ergative case (and potentially other cases as well) is the result of agreement with multiple heads. Given this assumption, the ungrammaticality of (299) also does not require the projection of a DP or ϕ P specifier, and the presence of the embedded agent as a free variable would suffice for the embedded clause to count as active, thus preventing the raising of the embedded theme.

Moreover, if the embedded agent is projected as a ϕ P and raises to grammatical subject position (i.e. Spec,TP) in impersonal passives (cf. 237-238), this predicts that it should be able to trigger matrix agreement (Legate 2014). However, it always surfaces with default agreement in SA. Consider (301) in which the embedded subject is necessarily female, but feminine agreement on matrix ‘make’ is still ruled out in impersonal passives.

- (301) in-sa / *in-sa-tte cab ibin-ma fi dınye fi şart-ad
 PASS-made.3M / *PASS-made-3F bring.INF baby.boy-a in world in condition-PL
 kotti-yin
 bad-PL
 ‘It was made deliver a baby boy in unsafe conditions.’

Note also that raising of ϕ P presupposes the availability of Spec,TP in impersonal pas-

³⁴In fact, Legate has also moved away from this position, and argues for VoiceP that allows ACC without a specifier (Legate 2021).

sives, which is not an innocuous assumption. Pitteroff and Schäfer (2019) argue that in languages with impersonal passives, (i) Spec,TP is either filled by an overt expletive or (ii) Spec,TP is not projected. Sason Arabic, being a language that shows impersonal passives of unergatives, should then follow one of these two options. Given the absence of an expletive in the language, I assume that Spec,TP is not projected in impersonal passives.

3.2.4.4 Against a responsible party for SA and Turkish

In this section, I examine the pragmatic notion of a *Responsible Party* (RP) of an event, and argue that this notion is not at issue for Sason Arabic and Turkish.³⁵

The basic idea is that certain Parties (typically entities) may be contextually interpreted as Responsible for an event (e.g. Williams 2015; Biggs and Embick 2020), in a manner that can be distinguished from an asserted (Agent or Causer) thematic role. It has been argued that in English the agent and the RP can be dissociated, and certain operations including control or agent-oriented adverbs do not require a syntactically represented argument, and RPs can serve as controller of PRO in rationale clauses or be the entity associated with an adverb such as ‘deliberately’. Applying the relevant configurations in SA and Turkish, I demonstrate that they lead to oddness in these languages, which I take to mean that in SA and Turkish the agent and the RP overlap. As such, across these languages, these diagnostics pick out a syntactically (or semantically) present agent, and not an entity implicated in the event.

Let’s first look at the status of adverbs such as *deliberately*, *intentionally*, *on purpose*. It has been shown for English that these adverbs are not restricted to hosts that have an Agent thematic relation, and therefore do not require the presence of a grammatically represented Agent. Consider (302).

- (302) The shop window has a big sale sign in it deliberately/intentionally/on purpose.
(Biggs and Embick 2020:p, 25)

³⁵I discuss Turkish as well in this chapter since it is relevant to the discussion of Turkish throughout the dissertation.

Similarly, in (303), the grammatical subject *MLK*, which is also a theme, can be associated with the adverbs. Therefore, it is plausible to assume that *MLK* underwent an arrest deliberately, intentionally, or on purpose.

(303) *MLK* was {deliberately/ intentionally} arrested last night {on purpose} (Jackendoff 1972:83, as cited in Biggs and Embick 2020:67)

Turning to SA and Turkish, we see that the counterparts of these examples are ill-formed. The contrast between (305b) and (305c) is particularly informative in showing that in both sentences ‘Kemal’ has the same grammatical function, i.e. is the matrix subject. However, only in (305c), in which ‘Kemal’ is also the agent, can ‘Kemal’ be associated with the adverb ‘deliberately’. In (305b), where it bears the theme θ -role, it cannot; only the implicit agent of passive can be the controller of the adverb.

(304) Sason Arabic

- a. #babe le maḡaza bılqasti ifi-llu işara-ma gbir-ma
 door of shop deliberately exist-it.M sign-a big-a
 Intended: ‘The shop door has a big sign on it deliberately.’
- b. Kemal m-haps bılqasti ams lele
 Kemal PASS-arrested deliberately yesterday night
 ‘Kemal was arrested last night deliberately.’
 YES: Someone deliberately arrested Kemal.
 NO: Kemal deliberately underwent an arrest.

(305) Turkish

- a. #mağaza kapı-sı-nda bilerek/kasten kocaman bir indirim
 shop door-CM-LOC deliberately/intentionally big a sale
 logo-su var.
 logo-CM exist
 Intended: ‘The shop door has a big sign on it deliberately/intentionally.’
- b. Although he was innocent,
 Kemal dün gece (polisler tarafından) bilerek/kasten
 Kemal yesterday night (police-PL by) deliberately/intentionally

haps-e at-ıl-di.
jail-DAT throw-PASS-PST

‘Kemal was arrested last night deliberately/intentionally (by the police).’

YES: Someone deliberately arrested Kemal.

NO: Kemal deliberately underwent an arrest.

- c. Although he was innocent,

Kemal dün gece kendi-ni bilerek/kasten haps-e
Kemal yesterday night self-ACC deliberately/intentionally jail-DAT
at-tır-di.
throw-CAUS-PST

‘Kemal had himself arrested last night deliberately/intentionally.’

YES: Kemal deliberately underwent an arrest.

Note also that even in English other diagnostics that pick out an external layer (i.e. Voice) such as instrumentals are not grammatical in such constructions. Consider (306). This also raises questions about the use of adverbials as the only diagnostic for the RP.

- (306) a. I hung the clothes in the window with a wire.
b. The clothes were hung in the window with a wire.
c. #The clothes hung in the window with a wire.
d. #The store had clothes in the window with a wire.

Second, certain constructions, e.g. unaccusatives, in English point to the absence of syntactic-semantic agentivity for control of rationale clause PRO. This is illustrated in (307).

- (307) a. The thermostat is on low [PRO to save money]. (Biggs and Embick 2020:66e)
b. Flamingoes are pink [PRO to attract the opposite sex]. (Williams 1985)

Turning to SA and Turkish, we see that for most speakers the rationale clauses result in ungrammaticality. The a. examples in (308) and (309) demonstrate that rationale clauses are out, whereas the b. examples which do not contain rationale clauses, i.e. no control, are licit. Most speakers of Turkish note that (309a) feels ‘incomplete’, and provide (309c) as an alternative.

(308) Sason Arabic

a. daraca qille ye [*PRO mışa hatt dırem]
thermostat low COP.3SG [to save money]
'The thermostat is on low [*to save money].'

b. daraca qille ye [ta le i-hat dırem]
thermostat low COP.3SG [so that 3M-save money]
'The thermostat is on low [so that he saves money].'

(309) Turkish

a. Işık-lar [*PRO tasarruf et-mek için] loş.
light-PL [save.money-NMLZ for] dim
'The lights are dim [*to save money].'

b. Işık-lar [tasarruf ed-e-lim diye] loş.
light-PL (save.money-OPT-1PL so.that dim
'The lights are dim [so that we save money].'

c. Işık-lar [PRO tasarruf et-mek için] loş tut-ul-uyor.
light-PL [save.money-NMLZ for] dim keep-PASS-PROG
'The lights are being kept dim [to save money].'

The so-called “author” examples are another context usually reported from English (see Williams 1985) to demonstrate that RP can be distinguished from the Agent. In (310b), the RC PRO can be understood to be controlled by whoever is in charge of plotlines in the story in which John is a character. Its counterpart in SA, (311), and Turkish, (312), are ungrammatical.

(310) a. John sank the ship in episode 2 [PRO to motivate the confrontation in episode 8]. (Biggs and Embick 2020:78)

Agent = John

Writer of the series = RP

b. The ship sank in episode 2 [PRO to motivate the confrontation in episode 8].

(311) Sason Arabic

gami in-qalab-e fi qısm 2 le kitab [*PRO mışa tel harp fi qısm 8].
ship NACT-sank-3F in chapter 2 of book [to create war in chapter 8]

‘The ship sank in chapter 2 of the book [*to start a war in chapter 8].’

(312) Turkish

Gemi [*PRO kitab-ın 8. kısım-ı-nda gerilim-i arttır-mak için] 2.
ship [book-GEN 8 chapter-3POSS-LOC tension-ACC increase-NMLZ for] 2
kısım-da bat-tı.
chapter-LOC sink-PST

‘The ship sank in chapter 2 of the book [*to increase the tension in chapter 8].’

3.2.4.5 Interim Summary

Thus far, we have seen that ‘make’-causatives in Sason Arabic embed a reduced structure, with no AspP or higher projections. However, it embeds a thematic VoiceP with active-passive alternation despite the absence of any morphological reflex. The embedded passive VoiceP is characterized by the obligatory presence of a ‘by-phrase. The active VoiceP, on the other hand, lacks a specifier position, and the embedded agent is available only as a ‘free variable’ on the active Voice head.³⁶

Next, I turn to a third structure that ‘make’ embeds, i.e. instances in which the embedded agent can indeed be pronounced and investigate the properties of those instances.

3.2.5 Locality and Licensing

Recall from the previous section that the embedded agent cannot be pronounced in-situ.

(313) iya sat-te (*nes-ma / *talaba-ma zāki) addil odav.
she made-3F (*person-a / *student-a smart) do.INF homework
‘She made someone / a smart student do the homework.’

³⁶William Johnston (p.c.) raises the possibility of treating the embedded agent as an arbitrary PRO, noting that the scope facts noted above seem to behave in a similar way to English PRO.

- (i) The university didn’t make it difficult PRO to register.
 - a. The university didn’t make it difficult for anyone to register.
 - b. #There’s an arbitrary person such that the university didn’t make it difficult for them to register.

What leaves a PRO analysis undesirable is the following: why is it that PRO can normally bind anaphors, including in the parallel English example, e.g., *The university didn’t make it difficult/easy PRO to sign oneself up for classes*, in addition to the other control, gerundial configurations in Sason Arabic; but not in ‘make’-causatives. It doesn’t strike me as appealing to say that PRO, which is projected (and is null), can normally bind; but not in this specific configuration. Crucially, this cannot be solely about overtness either, since *pro* is capable of binding anaphors, depictives etc (even in *pro*-drop contexts, where the null *pro* - and not the overt DP - is the only option due to information-structure).

Relatedly, it cannot bind anaphors or license depictives, while it can be the anchor for pronouns. This motivated an analysis of ‘embedded agent as a free variable’.

- (314) *iya_i sat-te addil_k odav (*mıŝa rou_k / roen_k).*
 she made-3F do.INF homework (*for himself / themselves)
 ‘She_i made (some person_k/people_k) do the homework (*for himself_k/themselves_k).’

Notably, \bar{A} -movement (*wh*-question, relativization, focus) licenses the overt realization of the embedded agent, (315).

- (315) a. *wh*-question

ande mafya sa qadıl hasm-u?
 who mafia made murder.INF enemy-his
 ‘Who did the mafia leader make murder his enemy?’

- b. relativization

sima-tu mı nes-ma gbir le mafya sa qadıl hasm-u
 heard-1SG by person-a big that mafia made murder.INF enemy-his
 ‘I’ve heard about some big person that the mafia leader made murder his enemy.’

- c. contrastive focus

nes-ma gbir mafya sa qadıl hasm-u (nes-ma istudi lā)
 person-a big mafia made murder enemy-his (person-a small no)
 ‘A big person, the mafia made murder his enemy (not a small one).’³⁷

Interestingly, when the agent is \bar{A} -moved, reflexive binding, reciprocal binding, and depictives become possible:

- (315) a. reflexive

ande_k iya sa-tte addil odav (mıŝa roen_k)?
 who she made-3F do.INF homework for themselves
 ‘Who_k did she make do the homework for themselves_k?’

³⁷In addition to the corrective, contrastive focus interpretation, list focus is also possible, (i).

(i) *Kemal sa CİNAR-MA TAWWİL hazd haŝıŝ, u Leyla satte CİNAR-MA NAXAR hazd-u.*
 Kemal made neighbor-a tall cut grass and Leyla made-3F neighbor-a other cut-it.M
 ‘Kemal made SOME TALL NEIGHBOR cut the grass, and Leyla made SOME OTHER NEIGHBOR do so.’

Thanks to Elsi Kaiser (p.c.) for bringing this to my attention.

b. reciprocal

ande_k pro sa-tte bās baz-en_k?
who made-3F kiss.INF each.other-3PL
'Who_k did she_i make kiss each other_k?'

c. depictive

ande_k si-t karu xanni (sarxoš_k)?
who made-2M write song (drunk)
'Who_k did you make compose the song drunk_k?'

This indicates that when the embedded agent is null, it is not syntactically projected, whereas when it is \bar{A} -moved, it is necessarily projected.

A number of languages have constructions in which arguments cannot remain in their base-generated position, and need to move to be 'rescued'. As such, certain positions cannot be occupied by overt material at Spell-Out. Such constructions include *wager*-class verbs in English, as in (316), (Postal 1974, 1993; Pesetsky 1991, 2016; Bošković 1997, 2002; Richards 2001; Rezac 2013, i.a.), Romance infinitives (Kayne 1975, 1984; Rizzi 1982; Bošković 1997, i.a.), and applicativized arguments in Malagasy (Pearson 2001) and Tagalog (Pearson 2001; Richards 2001; Rackowski and Richards 2005; Legate 2014).

- (316) a. *John wagered the woman to know French. (Bošković, 2002, (53))
b. the woman that John wagered to know French

Therefore, 'make'-causatives are part of this larger crosslinguistic pattern, in which an argument cannot remain *in-situ*, and needs to move. The nature of this phenomenon has remained as a long-standing puzzle despite a large body of work. The approaches attempting to account for this phenomenon can be classified into three main categories: (i) locality restrictions, (ii) a PF-constraint, (iii) Exfoliation, i.e. deletion of projections from a full clause. Bringing in a new perspective to this puzzle, SA provides new evidence that supports a locality-based analysis. Specifically, the embedded agent is not (Case-) licensed, separated from its licenser by a *phase* domain. \bar{A} -movement places them in a local configuration.

3.2.5.1 Analyses of Romance ECM type constructions

One main approach to *wager*-class and Romance ECM verbs revolves around locality restrictions which mainly concern the presence of an extra layer or projection, although the primary motivation for this varies (e.g. Kayne 1984; Pesetsky 1991; Rochette 1988; Bošković 1997, 2002; Rezac 2013). For instance, Bošković (1997, 2002) argues that the generalization that agentive verbs cannot exceptionally case-mark lexical NPs can be captured from the proposal that such verbs have an additional VP shell. This additional VP shell in *wager*-verbs renders the accusative-checking position matrix [Spec, AgrOP] too far from the embedded clause-subject, thus (317). He argues that the agentive shell, i.e. VP2, is not present with *believe*-verbs, thus (318).

(317) *John_i wagered_v [AgrOP the woman_j t_v [VP2 t_i t_v [VP1 t_i t_v [IP t_j to t_j know French]]]]. (adapted from Bošković 2002,193:(53))

(318) John_i believes_v [AgrOP Peter_k t_v [VP1 t_i t_v [IP t_k to t_k be crazy]]]. (Bošković 1997,55:(11))

Rezac (2013, 313-315) suggests that in *wager* but not *believe* ECM, a silent N⁰ in [v/V_{Acc} [N⁰ Inf]] intervenes in v/V_{Acc} ϕ -Agree but becomes invisible by the time of T_{Nom} ϕ -Agree.³⁸ The guiding intuition behind Rezac’s (2013) proposal is similar to that of Pesetsky (1991), Bošković (2002) in that *wager* has a structure richer than *believe* in such a way that a Case problem arises and is obviated by \bar{A} -movement.

Rochette (1988, 335), following Kayne (1984), assumes the French (and Italian) ‘propositional’ infinitives in (319) to be CPs, as such “CP will act as a barrier with respect to government of the embedded subject position by the matrix verb, therefore precluding the possibility for Case assignment of the subject by the matrix verb”. In today’s terms, the

³⁸Rezac (2013) posits that in ECM+DOC, the indirect object intervenes in ϕ -Agree with the subject of the infinitive, and that \bar{A} -movement relates the infinitival subject to v/V_{Acc} by [uCase] valuation as a free rider on \bar{A} -Agree. Richards (2001, ch. 4) makes a similar point calling it “overcrowding”, in that in case of too many arguments in a particular position, one of them must move. Richards notes that an explanation based on ‘feature strength’, i.e. weak/strong features, is not enough, but leaves aside the exact nature of this phenomenon.

barrier roughly corresponds to phases, and Moulton (2009) adopts this approach for French *wager*-class verbs.

- (319) a. *Je croyais le garçon être arrivé.
 I believe the boy (to) have arrived.
 *R-to-O, (Rochette, 1988, 332:5a)
- b. Qui croyais-tu aimer Anne?
 Who believe-you to-love Anne
 Q-operator, (Bošković, 1997, 129:103a)
- c. Le garçon que je croyais être arrivé.
 The boy that I believed (to) have arrived.
 Rel-operator, (Rochette, 1988, 332:5a) (Moulton, 2009)

On the other hand, Pesetsky's (2019) *Exfoliation* hypothesis is built on the view that infinitives are built by reducing/deleting the C and T layers of the clause, and only when movement has taken place from an embedded subject or subject-like position is infinitivization possible (see also Pesetsky 2016, 2018). In other words, every embedded clause is built by Merge as a full finite CP, and may be reduced to a less than full clause only as a consequence of later derivational processes.

In contrast, Ito (2014) argues that the defective paradigm exhibited by *wager/assure*-class verbs in English stems from a PF constraint rather than a syntactic Case-theoretic mechanism. The argument is based on Lasnik's (2002) account of a Condition B amelioration effect with ECM verbs under the VP ellipsis. This approach suggests that when the ECM is a pronoun, it must raise in the syntax in order to cliticize onto the embedding verb at PF, and as a result of this it becomes a 'clause-mate', the relevant structural configuration relevant to Condition B based on (320), with the subject in the higher clause; hence the Condition B violation in (321a).

- (320) a. *John_i injured him_i.
 b. *Mary injured him_i and John_i did too.
- (321) a. *John_i affirmed him_i to be a genius.

- b. ?Mary affirmed him_i to be a genius and John_i did too. (Ito 2014:(9))

Crucially, under the VP ellipsis, the pronominal ECM subject can remain in the embedded subject position because the concomitant failure to cliticize (a PF violation) can be repaired by the VP ellipsis, as in (321b).

I argue that SA ‘make’-causatives provide support for a locality-based approach, and demonstrate that neither Exfoliation nor a PF-constraint captures the full range of facts in ‘make’-causatives.

3.2.5.2 Proposal: \bar{A} -extraction of embedded agent and phase-edge

I propose that SA facts provide a new, strong piece of evidence for locality-based analyses. In fact, both versions of locality analyses, i.e. those with barrierhood/phasehood (e.g. Kayne 1984; Rochette 1988; Moulton 2009) and those with an extra projection (e.g. Pesetsky 1991; Bošković 1997, 2002; Rezac 2013), are reconciled in SA. ‘Make’-causatives can be explained via a phase-based account, yet the *phase domain* is not CP (unlike Romance), but a low focus position, FP, above VoiceP. Secondly, the contrast between active vs. passive VoiceP in terms of the projection of FP is in line with an *extra projection*. Indeed, FP provides a stronger argument for the presence of an extra projection: in previous literature, this extra projection is either silent or postulated to be an intermediate landing site. In SA, however, this projection can host overt material, thus indicates that a potential prediction of this analysis is borne out.

Before proceeding with the proposal, I note that several arguments converge that the focus operation (also *wh*-questions and topicalization) in SA is necessarily the result of overt movement and not base-generation (or QR; cf. (324) and (325) given the clause-boundedness of QR). The ban against in-situ focusing holds for any focusable constituent, as illustrated for an object in (228). Secondly, focus obeys island conditions, as in (322), in which an embedded agent can cross clausal boundaries, but has to obey CNPC. This is in contrast to CLLD, (323), which is island-insensitive in SA.

- (322) a. CINAR-MA sima-tu le kemal sa faqz, (recel-ma pir lā)
 neighbor-a heard-1SG that Kemal made run man-a old no
 ‘A neighbor, I heard that Kemal made run (not an old man).’
- b. *CINAR-MA sima-tu iddā le kemal sa faqz, (recel-ma pir lā)
 neighbor-a heard-1SG claim that Kemal made run man-a old no
 ‘A neighbor, I heard the claim that Kemal made run (not an old man).’
- (323) a. *balgife* sima-tu le kemal sa xassil-*a*.
 pillow heard-1SG that Kemal made wash-it.F
 ‘*The pillow*, I heard that Kemal made someone wash *it*.’
- b. *balgife* sima-tu iddā le kemal sa xassil-*a*.
 pillow heard-1SG claim that Kemal made wash-it.F
 ‘*The pillow*, I heard the claim that Kemal made someone wash *it*.’

Reconstruction effects also show that focus is movement-driven: in (324), the pronoun inside a focused embedded agent that precedes the matrix quantified subject can still be bound, indicating the reconstruction of the focused constituent. In (325) despite the reconstruction of the focused embedded agent, the pronoun is still unbound since in its reconstructed position it is structurally higher than the binder, i.e. the embedded object.

- (324) MARA-MA_k WARA FUTURAF-U_{i/*k}, saddix-tu kul mayni_i sa xadu sahne
 woman-a with picture-3M.POSS thought-1SG every singer.M made walk stage
 ‘Some woman_k with his_{i/*k} picture, I thought that every singer_i made come to stage.’
- (325) MARA-MA_k WARA ÇARCAVA-U_{*i/*k}, saddix-tu le dāde sa-tte xassil
 woman.F-a with frame-3M.POSS thought-1SG that mother.F made-3F wash.INF
 kul rasm_i
 every painting.M
 ‘Some woman_k with its_{*i/*k} frame, I thought that mom made wash every painting_i.’

Recall that the embedded active, but not passive, VoiceP is dominated by FP (see section 3.2.1.2). It is FP that causes the locality problem, and prevents the embedded agent from remaining in-situ in Spec,VoiceP. I argue that the F head embedded under ‘make’ is a *phase-head*,³⁹ and hosts \bar{A} -features (following e.g. Chomsky 2000, 2001; Abels 2012; also see

³⁹This is to distinguish it from FP in root clauses which patterns differently, and thus does not count as a phase domain. This is because whether FP is selected by ‘make’, thus is obligatorily projected, or

Van Urk 2015; Van Urk and Richards 2015), including focus.⁴⁰ Compare (326) and (327).⁴¹

(326) *active embedded VoiceP*

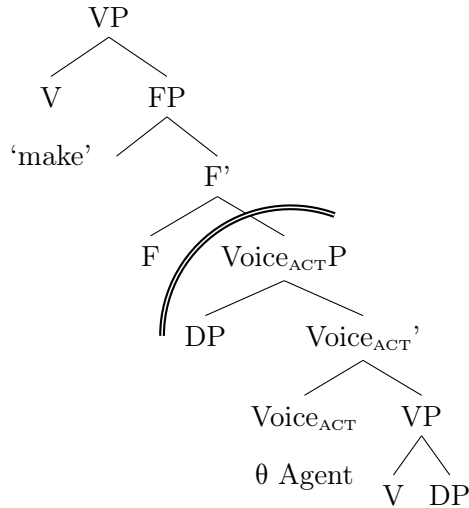

(327) *passive embedded VoiceP*

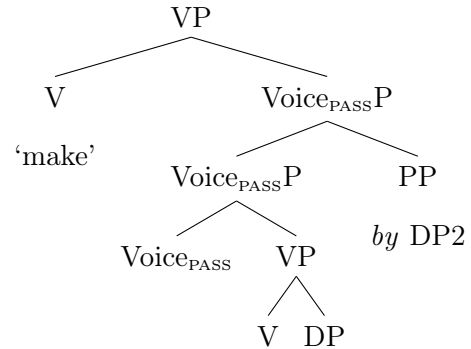

Note that this analysis mainly relies on two components: (i) a locality domain for licensing, and (ii) the presence or absence of a higher licenser. Given the components, it is possible to test the predictions of the analysis. Logically and empirically, we have four possible configurations depending on the diathesis of matrix and embedded clauses: (i) passive > passive, (ii) active > passive, (iii) active > active, (iv) passive > active. The proposed analysis makes predictions for each of these configurations.

Let us start with the two configurations in which the embedded Voice is passive, and thus FP is not projected.

3.2.5.2.1 Passive > Passive When both the matrix and embedded structures have passive Voice, the embedded object is licensed by matrix NOM, as in (328a), as such it

it is optionally projected in non-embedded clauses makes a difference. The contrast is very reminiscent of the phasehood analysis Deal (2016) provides for Nez Perce relative clauses. She argues that TP is a phase only in relative clauses in Nez Perce. I implement this in SA by adopting Bošković's (2014) concept of contextual phasehood, according to which the highest phrase in an extended projection counts as a phase (see also Wurmbrand 2017:48). Accordingly, in 'make'-causatives, FP is the highest phrase of the embedded projection, and the matrix verb dominating it starts off a new domain, whose FP is not a phase head since it is not the highest phrase of that projection, and is dominated by other categories.

⁴⁰See Kahnemuyipour and Megerdooian (2011, 2017) who argue that the head of the low focus position, F, is a phase head in Armenian (more explicitly in their latter work).

⁴¹In most tree representations, I leave out *v* since it is not central to the discussion.

raises to grammatical subject and manifests subject-verb agreement (note that the configurations are very similar to restructuring of Wurmbrand 2001 et seq). The corresponding tree structure is represented as (328b).

- (328) a. potad in-so (mi Kemal) [xassil mi mara-ma pir-e].
 clothes PASS.PFV-made.3PL (by Kemal) [wash.INF by woman-a old-F]
 ‘Clothes were made (by Kemal) to be washed by some old woman.’

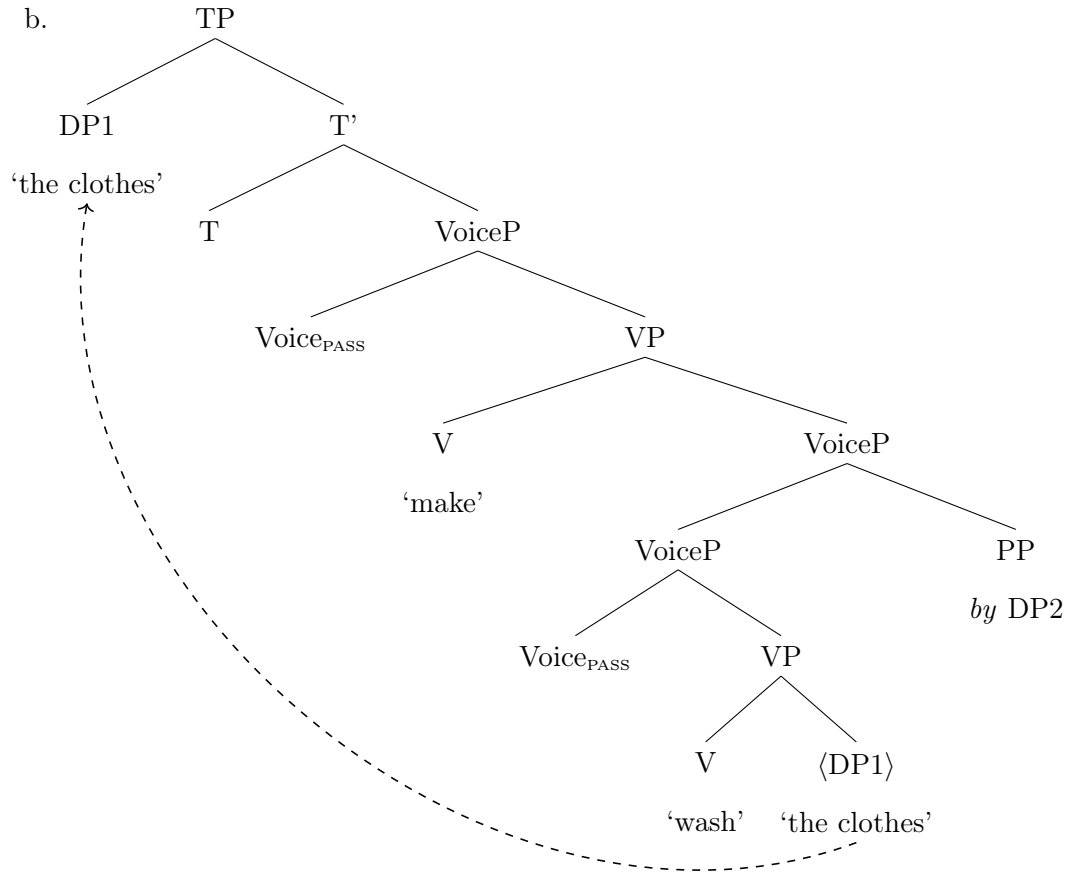

3.2.5.2.2 Active > Passive Given that there is no intervening phase, when the matrix verb is active, the matrix verb can license the embedded object, e.g. (329a-329b).

- (329) a. kemal sa [xassil potad mi mara-ma pir-e].
 kemal made.3M [wash.INF clothes by woman-a old-F]
 ‘Kemal had the clothes washed by some old woman.’

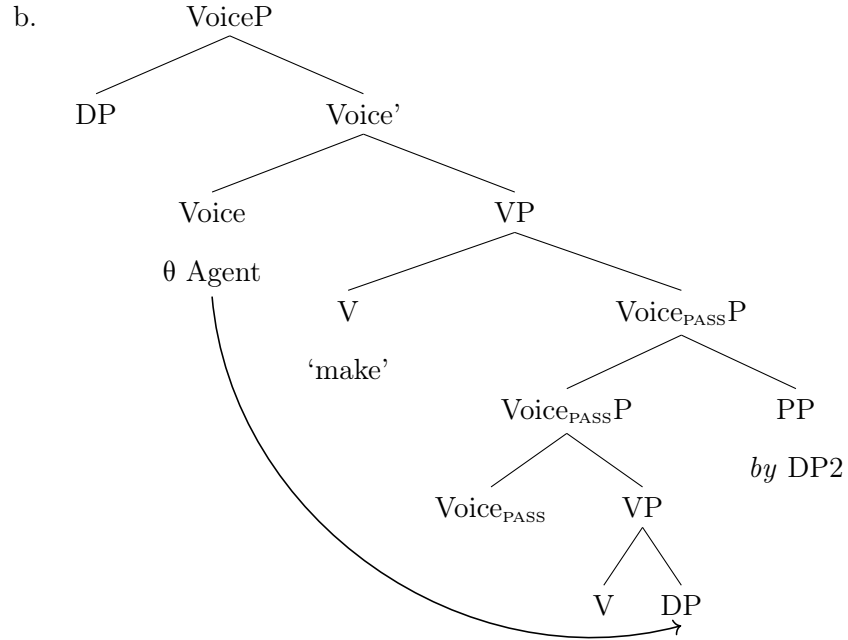

Let us now turn to with embedded active Voice, which are dominated by FP.

3.2.5.2.3 Active > Active In this configuration, the presence of FP above VoiceP explains why the embedded agent may not remain in-situ, (330a). This is because, being a phasal domain, FP intervenes in the licensing of the embedded agent by the matrix Voice, as in (330b).

- (330) a. *mafya sa nes-ma gbir qadıl hasm-u
 mafia made person-a big murder.INF enemy-his
 ‘The mafia leader made a big person murder his enemy.’

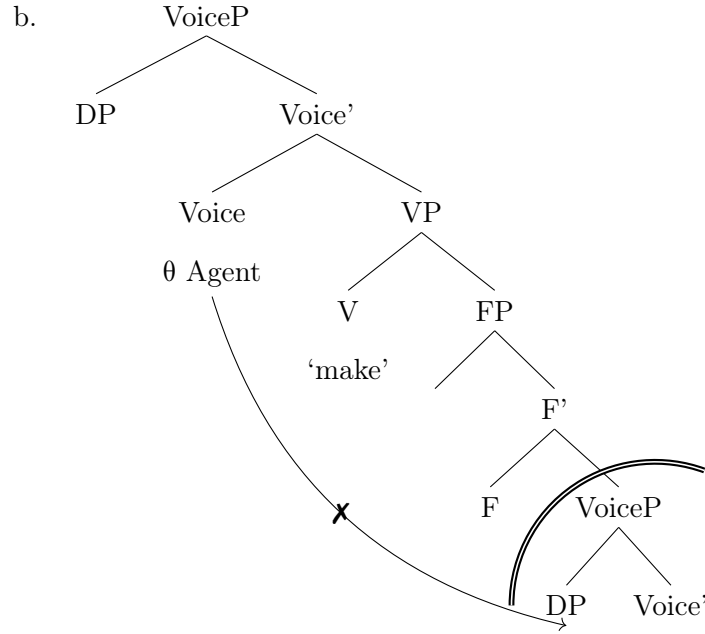

On the other hand, \bar{A} -movement makes the licensing possible (cf. Kayne 1984; Ura 1993; Bošković 1997; Rezac 2013).⁴² I suggest that this is because F can host \bar{A} -features, and as illustrated in (331), the embedded agent can raise to its edge, ❶. As such, the agent can be licensed by ‘make’ in a local configuration, ❷, in the spirit of e.g., Rezac (2013).

⁴²The ‘saving’ effect of \bar{A} -movement, or more generally the interaction between \bar{A} -movement and Case is a significant issue, and despite the common assumption that a DP does not get case after \bar{A} -movement, quite a few languages have been argued to exhibit this. Kayne (1984) and Pesetsky (1991) propose that \bar{A} -movement allows Case licensing by establishing new Case relations. Dikken (2009) and Lipták (1998) make the same argument for Hungarian, in that \bar{A} -movement past v/V_{Acc} assigns the otherwise unavailable accusative case (Rezac, 2013, sect. 5). Similar arguments for object case/agreement through \bar{A} -movement have been made on the basis of topicalization in Norwegian (Taraldsen, 1984), Turkish (Şener, 2011) and Passamaquoddy (Bruening, 2001), and for ‘Case attraction’ in Swiss German (Georgi and Salzmann, 2017). Abramovitz (2020) argues for an interaction between case and successive-cyclic *wh*-movement in which nouns along the path of *wh*-phrase’s movement path bear case-marking they would not otherwise have. These examples suggest that further research is needed to better understand the interaction between \bar{A} -movement and Case.

Note that in most of these examples the DP is already Case-licensed prior to movement (in a finite clause) and may receive another case post-movement. In ‘make’-causatives, the DP is not Case-licensed prior to movement. This straightforwardly follows from the size of the embedded constituent in ‘make’-causatives. Unlike other examples, in ‘make’-causatives the reduced structure lacks a licenser for the embedded agent; this is what distinguishes ‘make’-causatives. Yet, receiving case post-movement is identical.

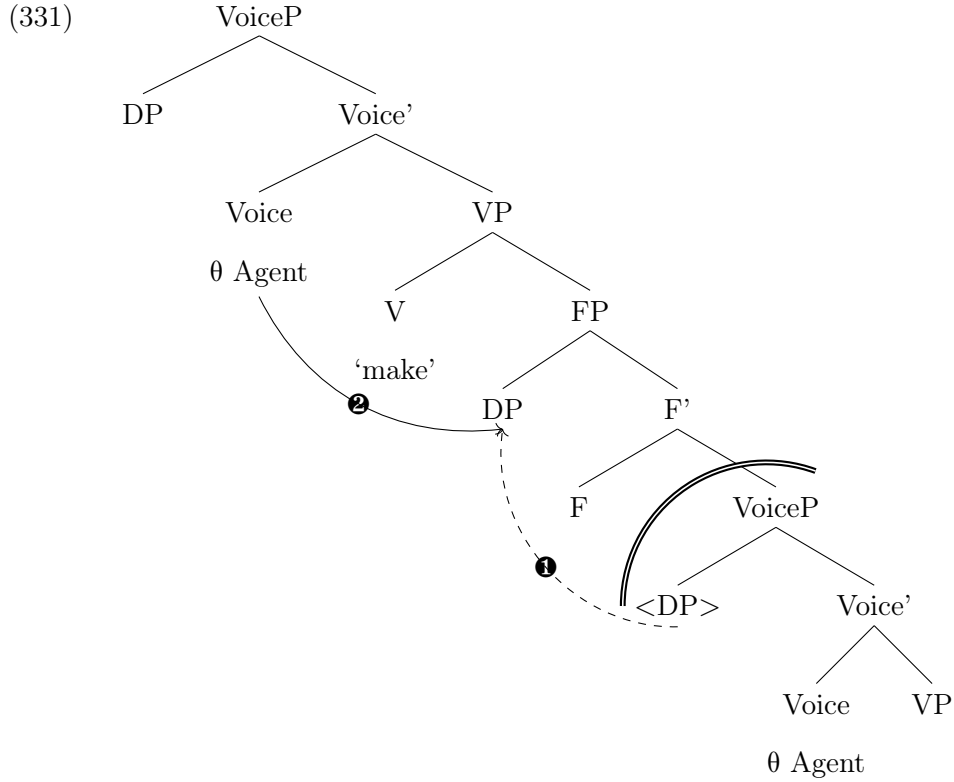

This analysis also explains the grammaticality of for instance (332) as opposed to (330a). Successive-cyclic movement of the embedded agent to a higher \bar{A} -position straightforwardly follows.

- (332) *sima-tu mī nes-ma gbir le mafya sa qadıl hasm-u*
 heard-1SG by person-a big that mafia made murder.INF enemy-his
 ‘I’ve heard about some big person that the mafia leader made murder his enemy.’

Moreover, (333), repeated from (230), shows that the specifier of FP in SA can also host pronounced material: it is the alternative landing site for the focused constituent, in this case *the embedded object*.

- (333) (ŞURVAN) kemal (*ŞURVAN) ku (ŞURVAN) i-si (ŞURVAN) xassil
 pants Kemal pants be.3M pants 3M-make pants wash.INF
 (*ŞURVAN), (qawa lā).
 pants shirt no
 ‘Kemal is making someone wash the pants, (not the shirt).’

As predicted by successive-cyclicity, Spec,FP can also host *the embedded agent* when it is contrastively-focussed. Consider (334), which provides strong evidence for the phase-based account in that FP acts as a barrier for ‘make’/Voice to license the embedded agent, unless the agent raises to the edge of the phase head.

- (334) a. *kemal sa cinar-ma faqz
 Kemal made neighbor-a run.INF
 ‘Kemal made a neighbor run.’
- b. (CINAR-MA) kemal sa (CINAR-MA) faqz, (recel-ma pir lā)
 neighbor-a Kemal made neighbor-a run (man-a old no)
 ‘Kemal made a neighbor run (not an old man).’

3.2.5.2.4 Passive > Active Finally, I illustrate the instance in which the matrix Voice is passive, but the embedded Voice is active. As discussed earlier in Section 3.2.2.1, this is an impersonal passive configuration in SA. Given that FP is available, we predict the availability of its edge for a focus constituent. This is illustrated to be the case in (336), which is schematized in the tree in (337).

- (335) m-sa xassil potad
 PASS-made wash.INF clothes
 ‘It was made (by somebody) someone wash the clothes.’
- (336) m-sa (POTAD) xassil (*POTAD), (balgife la).
 PASS-made clothes wash.INF clothes pillow no
 ‘It was made (by somebody) someone wash the clothes, not the pillow.’

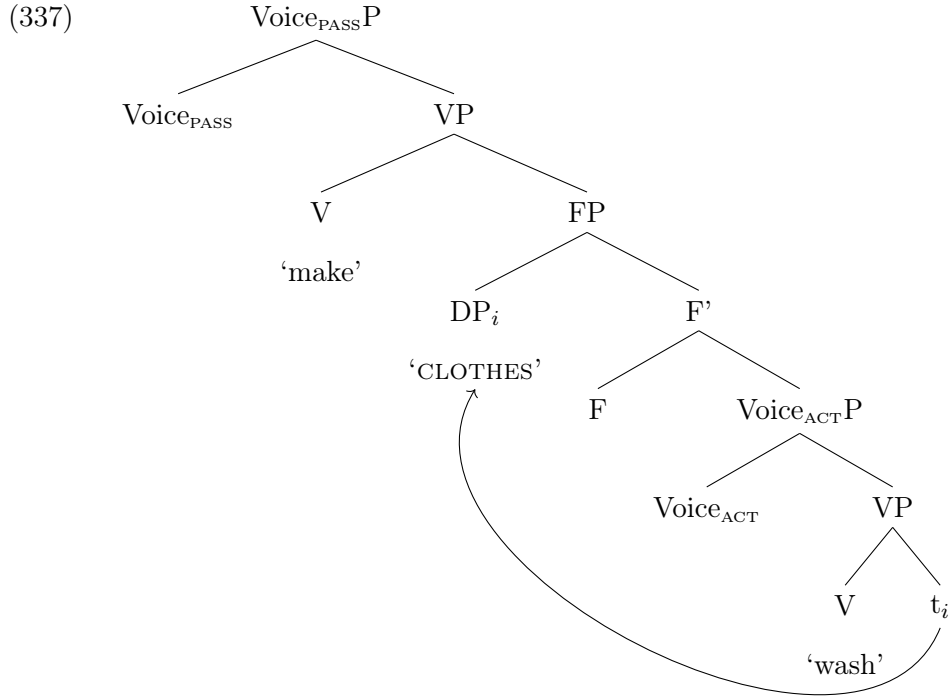

In contrast, in this configuration, the low position is unavailable for the embedded agent. This is predicted by the second component of the analysis: the need for a higher licenser.

- (338) *m-sa* (*CALABMA CINARAD) *xassil potad*, (*recel-ma tawwil lā*).
 PASS-made some neighbors wash clothes man-a tall no
 ‘It was made some neighbors wash the clothes, not some tall man.’

The analysis also makes predictions regarding the (im)possibility of focus position in other configurations. For example, the prediction is that in configurations with embedded passive VoiceP, the low focus position, FP, should be unavailable even for the raising of the embedded object. This is borne out; compare (339a) and (339b).

- (339) a. *kemal sa* [*xassil potad mī mara-ma pir-e*].
 kemal made.3M [wash.INF clothes by woman-a old-F]
 ‘Kemal had the clothes washed by some old woman.’
- b. **kemal sa* [*POTAD xassil mī mara-ma pir-e*].
 kemal made.3M [clothes wash.INF by woman-a old-F]
 ‘Kemal had THE CLOTHES washed by some old woman, (not the pillows).’

3.2.5.2.5 Why is A-movement ungrammatical? ‘Make’-causatives resemble the embedded infinitives in French and Italian, where raising-to-object constructions from infinitives can be rescued by a subset of the English *wager*-class rescuers. Similar to Romance infinitives, (340), SA embedded agents are only licensed by \bar{A} -movement, thus the ungrammaticality of (341) in the case of A-movement.

- (340) *Pierre était cru aimer Anne.
 Pierre was believed to-love Anne.
 *Passive Raising (French; Bošković 1997:130)⁴³

- (341) passive raising
 *calabma rıcel in-so xassil potad.
 some men PASS-made.3PL wash.INF clothes
 ‘Some men were made wash the clothes.’

I argue that the ungrammaticality is because this would be an instance of *improper movement*, i.e. an \bar{A} -movement followed by A-movement. The agent in ‘make’-causatives raises to Spec,FP, and then to Spec,TP, as in (343).⁴⁴

- (342) * [TP John_i seems [CP t_i [TP t_i knows it all]]]

- (343) Sason Arabic
 * [TP some men were made [FP t_i [VoiceP t_i wash the clothes]]]

This also means that \bar{A} -movement can feed Agree-based licensing, but cannot feed A-movement. This account also provides striking evidence for \bar{A} -movement feeding licensing

⁴³David Pesetsky informs me that certain variations of (74) are found to be acceptable by some French speakers, as noted in Pollock (1985, 307). Two French speakers we have consulted share the judgment reported in Bošković (1997), thus I continue to assume so since the focus of investigation is Sason Arabic.

⁴⁴This approach would also explain the same restriction observed for Romance infinitives. In Romance, the embedded subject would undergo successive cyclic movement through an embedded specifier of CP of the infinitival clause, an \bar{A} -position, and then to matrix TP, an A-position. Note that in English, passivization of the embedded agent is licit, (318). One could potentially conjure two paths of explanation: first, English may lack such an A-position as an intermediate landing site, as such *improper movement* is not an issue. Second, Moulton (2009) has contended that the passive in English *wager*-class verbs may not be verbal, but adjectival passives. If Moulton is right, then English passives would be of a different nature, though the compatibility *wager*-class verbs with progressive aspect in the passive speaks against their treatment as adjectival passives (thanks to David Pesetsky (p.c.) for alerting me to this). I leave it for future study a comprehensive investigation of this phenomenon in other languages.

relationships, thus explains the contrast between (266) and (315). In (266), the in-situ embedded agent is itself not licensed, and hence cannot be projected, in turn it cannot license anaphors or depictives. On the other hand, in (315), the embedded agent has been \bar{A} -moved and licensed by matrix Voice,⁴⁵ which makes it possible for it to license anaphors and depictives.

We might wonder if leaving the embedded agent in-situ would be grammatical in ‘make’-causatives. Let us start by establishing that in SA when T licenses a DP, it shows agreement with it whether the DP is an underlying subject or a derived subject (e.g. in passives). In addition, as shown above, and repeated here as (344), indefinite subjects can occupy a preverbal as well as a postverbal position, while definite subjects strongly prefer the preverbal position.

- (344) a. in-qafal-e baɣle-*(ma).
 PASS.PFV-caught-3F horse-*(a)
 ‘A/*?The horse was caught.’
- b. baɣle-(ma) in-qafal-e.
 horse-(a) PASS.PFV-caught-3F
 ‘A/The horse was caught.’

(345) shows that even an agreeing indefinite embedded agent cannot be licensed in-situ in Spec, VoiceP (or in matrix Spec, TP); it can be licensed in Spec,FP for some speakers.

- (345) [TP (*CALABMA CINARAD) in-so [FP (%CALABMA CINARAD) [VOICEACTP
 some neighbors PASS-made.3PL some neighbors
 (*calabma cinarad) xassil potad]]]
 some neighbors wash.INF clothes
 ‘Some neighbors were made wash the clothes (not some big man).’

In the absence of agreement, (345) becomes ungrammatical for all speakers in any position.

⁴⁵as such also overtly realized. This is reminiscent of Pesetsky’s (2019) *exposure*, in which the overt realization of an element is dependent on it satisfying certain requirements. The requirements for overtness, however, seem to be different. Whereas for Pesetsky (2019, 46), the overtness of *to* in infinitives depends on it becoming a phase head after Exfoliation and not retaining a specifier; in our case, it is the result of being licensed.

- (346) [CP (*CALABMA CINARAD) in-sa [FP (*CALABMA CINARAD) [VOICEACTP
some neighbors PASS-made.3M some neighbors
(*calabma cinarad) xassil potad]]].
some neighbors wash.INF clothes
‘It was made some neighbors wash the clothes (not some big man).’

Long passives further support the interaction between T-licensing and movement, showing that the licensed argument cannot remain in-situ. (347) minimally contrasts with (328a): both are long, personal passives, i.e. the matrix and embedded Voice are passive, and FP is not available. The embedded theme becomes the grammatical subject, and is licensed by T (indicated by agreement). Crucially in the grammatical (328a), the derived subject undergoes overt movement to Spec,TP, whereas in (347) it remains in the low position.⁴⁶

- (347) *in-so (mı Kemal) [VOICEPASS xassil calabma potad mı recel-ma pir].
PASS-made.3PL (by Kemal) [wash some clothes by man-a old]
‘Some clothes were made (by Kemal) to be washed by some old man.’

These patterns reveal that a T-licensed argument cannot remain in-situ in ‘make’-passives and (if possible) triggers raising to its licensing position, whereas the intermediate position is possible for some speakers. A Case-licensing account coupled with the interaction of T-licensing and movement is able to capture the facts.

In the next section, I investigate the alternative hypotheses, i.e. an Exfoliation approach and a PF-constraint, and argue that neither approach can fully explain ‘make’-causatives facts.

⁴⁶Note that there is a subject/object asymmetry only in that if the object needs licensing, there is no embedded FP, whereas if the subject needs licensing, there is. When the matrix licensor is Voice, the subject can raise to FP and be licensed from there. The object can also remain in FP, but in this case it is licensed in the embedded structure anyways. The object being licensed in FP by matrix Voice does not arise because if the object needs licensing, then the embedded VoiceP is passive, so FP is not present. When the licensor is T, the subject can raise to FP and be licensed from there for some speakers. Again, if the object needs licensing, then there is no embedded FP and so the question can’t be asked. For all speakers, when the matrix licensor is T, the subject/object can’t stay in situ, e.g. long passives (see also German, Wurmbrand 2001, 2007). The object can raise to TP, but the subject cannot due to improper movement. There is also a licensor asymmetry. When an embedded argument is licensed by matrix Voice, that argument can stay in FP. (Again subject is the only test case.) When an embedded argument is licensed by T, it can stay in FP only for some people. This is probably related to the absence of a higher grammatical object position with movement triggered by Voice, but the presence of a higher grammatical subject position with movement triggered by Voice.

3.2.5.3 Exfoliation

This hypothesis requires a transformation from an underlying full clause to an infinitive, and this derivation is possible only when movement has taken place from an embedded subject or subject-like position.⁴⁷ According to this approach, every embedded clause is built by Merge as a full finite CP, and may be reduced to a less than full clause only as a consequence of later derivational processes. The Exfoliation hypothesis comes along with several implications, one of which is the alternation of infinitives with finite clauses, out of which they are derived. For instance, in English *believe*-verbs alternate with full finite CP, (348).

- (348) a. Sue believes Mary to have solved the problem.
 b. Sue believes that Mary has solved the problem.

SA indeed has another causative construction with ‘make’ and an embedded finite clause, henceforth FM, as illustrated in (349). The question is whether there is a derivational relation between the causative construction in (349) and ‘make’-causatives.

- (349) a. büşra (mışa) kemal sa-tte f-iyu le *pro* ya-yez hadiya
 Büşra (to) Kemal made-3F in-him that 3M-buy present
 ‘Büşra made Kemal buy a present.’ (Yakut, 2013, 7)
- b. doxtor (mışa) ali ku i-si f-iyu (le *pro* y-addel) sipor
 doctor to Ali be.3M 3M-make in-him (that 3M-make) sports
 ‘The doctor is making Ali do sports.’ (Erguvanlı-Taylan, 2017, 221, with slight modifications)
- c. ams ayad_i (mışa) sabiyad_k so f-innen le *pro*_{*i/k/*m} /
 yesterday village.lords to boys made.3PL in-them that /
 innen_{*i/k/*m} ixsil-o potad lome.
 they wash-3PL clothes today
 ‘Yesterday the village lords made the boys wash the clothes today.’
 Lit: ‘Yesterday the village lords made the boys in them that they washed the clothes today.’

⁴⁷I am thankful to David Pesetsky for the discussion of this section.

Looking at this construction, we can note the following: the causee, e.g. *kemal* in (349a), itself is realized in the matrix clause, in the form of a PP or DP (in free variation).⁴⁸ Moreover, the causee is connected to a resumptive pronoun, itself contained inside a PP, i.e. *f-iyu* ‘in him’ in the matrix clause.⁴⁹ Moreover, the causee is realized as pro-dropped argument in the embedded clause, but it can also be realized as a reduced pronoun, as indicated in (349c). ‘Make’-causatives do not have any of these properties. The obligatory co-reference between the embedded subject and the causee in the matrix clause corroborates the causative relationship of this construction. Note also that this construction lacks the indefiniteness condition on the causee, which is available for ‘make’-causatives.

In addition to these properties, several issues challenge a derivational relation between FM and ‘make’-causatives, such that ‘make’-causatives are derived from FM via the truncation of CP and TP layers of the embedded clause. Given that Exfoliation is predicated on the movement of the embedded subject, we might expect to have a clause of the sort in (350) to be possible, contrary to fact. Note that placing the embedded subject *innen* ‘they’ anywhere else in the matrix clause makes no difference.

- (350) *ams aya mişa sabiyad sa f-innen innen [xassil potad].
 yesterday landlord to boys made in-them they [wash.INF clothes]
 ‘Yesterday the landlord made the boys to wash the clothes.’

One could argue that we would not expect a sentence like (350) simply because Exfoliation would not apply. This reasoning, however, would amount to saying that there is no derivational relationship between FM and ‘make’-causatives.

A significant difference between FM and ‘make’-causatives relates to the requirement regarding the external argument. As shown in Section 3.2.1.3, ‘make’-causatives allow causers such as ‘earthquake, fear’ to be matrix subjects, (351a, although it disallows inanimate arguments such as ‘stone’). In FM as well inanimate subjects are disallowed, yet causers

⁴⁸The optionality was not indicated in Erguvanlı-Taylan (2017), but my intuitions are in the same direction as other examples, thus I modified the original example.

⁴⁹The position of the resumptive pronoun in the matrix clause is supported by the fact that adverbs such as *kasinlikla* ‘definitely’, *wara kul kalb-a* ‘with all her heart’ typically occur between this resumptive pronoun and the complementizer *le* ‘that’.

are also out, (351b). This difference is unexpected if we assume a derivational relationship between FM and ‘make’-causatives.⁵⁰

- (351) a. zelzele sa-tte maş buyud
 earthquake made-3F leave.INF houses
 ‘The earthquake made (some people) leave houses.’
- b. *zelzele (mısa) kemal sa-tte f-iyu le pro m-i-xxel beyt
 earthquake (to) Kemal made-3F in-him that NEG-3M-enter house
 ‘The earthquake made Kemal not enter home.’

This difference, on the other hand, is not an issue for the current analysis since it does not hypothesize a relation between the two configurations.

Another serious challenge for the Exfoliation approach comes from the contrast between (352) and (353). The Case-theoretic licensing and Exfoliation approaches make a clear prediction regarding the necessity of a licenser in the higher clausal domain. For the Case-theoretic licensing approach, the absence of a higher licenser should lead to a difference for the embedded subject, but not embedded object, since the former relies on a higher licenser, whereas the latter has an embedded licenser. However, for the Exfoliation approach, there should be no difference regardless of the presence or absence of a higher licenser because the embedded argument is licensed in the lower clause prior to Exfoliation. Making the matrix verb passive, we can test this prediction. The contrast between (352) and (353) is informative, and suggests that a licensing approach is the right one for ‘make’-causatives in SA. (352) shows that forming a question out of the embedded object is grammatical independently of the diathesis of the matrix clause. On the other hand, questioning the embedded subject is grammatical when the matrix Voice is active, as in (353a), but not passive, as in (353b). This is because although in both (353a) and (353b), FP is projected on top of embedded active VoiceP, only in the former is the embedded agent licensed by the

⁵⁰Another argument not discussed here relates to a point Pesetsky (2019, 14) makes about licensing. He suggests that the presence of finite T prior to Exfoliation is sufficient to case-license the subject in specifier of *toP*. Carrying this view to ‘make’-causatives, we would predict that the embedded subject to be able to license anaphors or depictives since it was licensed prior to Exfoliation. However, as seen in (266), this is not borne out.

matrix Voice.⁵¹ In (353b), the embedded subject may still raise to Spec,FP, but the higher licenser is not available since the matrix-clause predicate is passive.⁵²

- (352) a. $\text{\textsubscript{1}\text{\textbar{S}}}$ kitab iya sa-tte qaru?
 which book she made-3F read.INF
 ‘Which book did she make somebody read?’
- b. $\text{\textsubscript{1}\text{\textbar{S}}}$ kitab m-sa qaru?
 which book PASS-made read.INF
 ‘Which book was somebody made to read?’
- (353) a. ande iya sa-tte xassil potad?
 who she made-3F wash.INF clothes
 ‘Who did she make wash clothes?’
- b. * $\text{\textsubscript{1}\text{\textbar{S}}}$ ande m-sa xassil potad?
 who PASS-made wash.INF clothes
 ‘Who was to made wash the clothes?’

3.2.5.4 PF-constraint

Finally, I look at another alternative approach, i.e. a PF-constraint (and its versions), to this phenomenon. I demonstrate that a PF-constraint suggested for English ECM-verbs cannot carry over to ‘make’-causatives for several reasons: First, the primary motivation

⁵¹Interestingly, (353b) and (i) are out even for speakers that allow (345). This shows that movement of the embedded subject cannot skip the matrix TP position.

- (i) * $\text{\textsubscript{1}\text{\textbar{S}}}$ sabiyad m-so xassil potad?
 which kids PASS-made.3PL wash.INF clothes
 ‘Which kids were to made wash the clothes?’

⁵²Note that the embedded agent can be questioned when realized as a ‘by’-phrase, similar to *by whom were the clothes washed* in English. This also indicates that there is not a general ban against questioning the subject when clause is passive.

- (i) a. *mi ande* potad m-xasal-o?
 by whom clothes PASS-washed-3PL
 ‘By whom were the clothes washed?’
- b. (?) *mi ande* potad m-so xassil _?
 by whom clothes PASS-made.3PL wash.INF _
 ‘By whom were the clothes made wash?’

Note also that leaving the *wh*-phrase in-situ is disallowed in both (ia) and (ib).

Lasnik (2002) and Ito (2014) use to propose a PF-constraint for English, i.e. the availability of pronouns as embedded subjects, is not possible in ‘make’-causatives.

- (354) *mafya sa iyen qadıl hasm-en
 mafia made.3M them murder.INF enemy-their
 ‘The mafia leader made them murder his enemy.’

Secondly, a constraint of obligatory PF adjacency between ‘make’ and the ‘infinitive’ cannot be at work. Light verb constructions indicate at least that at the phonological level adjacency is not required. SA has developed the light verb construction as a result of contact with Turkish and Kurdish (Akkuş and Benmamoun, 2018; Erguvanlı-Taylan, 2017), in which the non-verbal element precedes the light verb, thus resulting in the order “make - nonverbal element - light verb”. Consider (355).

- (355) kemal [sa buay sir] beyt wara furça-d gbar
 Kemal [made.3M paint do.INF] house with brush-PL big.PL
 ‘Kemal had someone paint the house with big paint brushes.’

The complex predicate analysis is also not tenable, as evinced by instances of contrastive focus throughout the chapter. Moreover, the contrast between (266) and (315) in terms of anaphor binding or depictive licensing also suggests that it cannot be a pure PF constraint, as Ito (2014) argues for English *wager*-class verbs. This is because SA is a pro-drop language. If it were just a PF issue, we would expect anaphor binding or depictive licensing to be possible in the complements of ‘make’, contrary to fact.

3.2.5.5 Interim Summary

The examination of ‘make’-causatives has revealed that ‘make’ can embed three structures.

(356) passive VoiceP

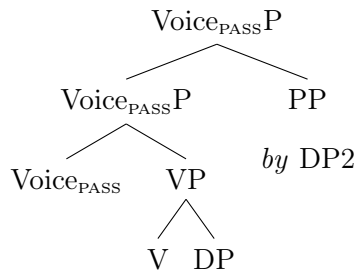

active VoiceP
(variable agent)

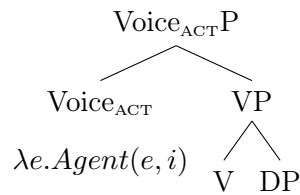

active VoiceP
(full DP agent)

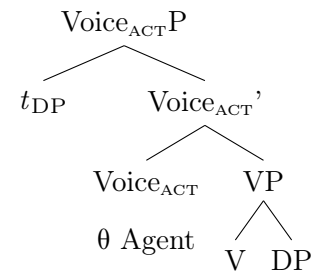

As seen from (356), ‘make’-causatives embed a reduced structure: no AspP or higher projections (i.e. a restructuring configuration). It embeds a passive VoiceP, or an FP dominating an active VoiceP. This construction provides insights into long-standing issues in syntactic theory and the syntax-semantics interface.

The embedded agent can be introduced in two ways in the active VoiceP: (i) as a ‘free variable’ on the Voice head. This adds to the typology of implicit arguments. It also shows that the theme can be (Case-) licensed as an object independently of the thematic subject. (ii) as a full DP, which is subject a locality restrictions. The embedded agent needs to \bar{A} -move to be in local configuration with its licenser. As such, ‘make’-causatives are part of a larger crosslinguistic pattern, in which certain positions cannot be occupied with overt elements.

In the rest of the chapter, I examine two other causative strategies in SA, i.e. gemination and ‘give’ causatives.

3.3 Geminate and ‘give’-causatives in Sason Arabic

In this section, I provide independent evidence for the analysis of passive argued for in Chapter 1 (following Legate 2014; Legate et al. 2020), on the basis of the geminate causatives and causatives embedded under ‘give’ in Sason Arabic (SA).

Legate (2014) treats passive as a variant of a functional head that introduces a DP in its specifier. One prediction of this analysis is that an active-passive-like alternation should be

possible on another functional head such as Appl as long as the language in question allows the existential closure to apply to the Appl head and has a PP with the right semantics. Moreover, similar to its Voice counterpart in certain circumstances, this passivization does not necessarily end up with a morphological reflex. I argue that this is exactly the case in Sason Arabic.

As briefly mentioned in §3.1, one strategy to form causatives in SA is via gemination. In this strategy, the causative affix is realized by geminating the second cardinal of the stem. This strategy allows the causee of an underlyingly transitive verb to be expressed either as a DP or a PP headed by *mīṣa* ‘to, for’, as in (357).

- (357) a. fatma qad-e ras-a
 Fatma cut.PST-3F hair-her
 ‘Fatma cut her hair.’
- b. fatma qatt-e kuafor ras-a
 Fatma cut.CAUS-3F hairdresser hair-her
 ‘Fatma had the hairdresser cut her hair.’
- c. fatma qatt-e ras-a mīṣa kuafor
 Fatma cut.CAUS-3F hair-her to hairdresser
 ‘Fatma had the hairdresser cut her hair.’ (Erguvanlı-Taylan, 2017, 29)

Unergative verbs also may show a geminate causative counterpart. Consider (358), in which the causee is realized as a bound pronoun.⁵³

- (358) a. i-zak
 3M-laugh
 ‘He laughs.’
- b. a-zakkīy-u
 1SG-laugh.CAUS-him
 ‘I make him laugh.’

There is a contrast between unergative and transitive verbs in terms of how the causee may be expressed. Unlike transitive verbs, which allows the introduction of the causee as a DP

⁵³Like other Arabic vernaculars, SA has lost its overt case and mood markings on nouns and verbs, respectively. Only overt pronouns obtain morphological case distinctions whereby nominative-assigned pronouns surface as free-standing elements, whereas accusative and genitive-assigned pronouns surface as bound pronouns that are attached to their assigners.

or a PP, the causee of a causativized unergative verb can only be expressed as a DP, as in (359) and (360).

- (359) a. kemal amal
 Kemal worked.3M
 ‘Kemal worked.’
- b. ammil-tu (*mı̄şa) kemal
 worked.CAUS-1SG to Kemal
 ‘I made Kemal work.’
- (360) a. kelb i-fqez
 dog 3M-run
 ‘The dog runs/is running.’
- b. kemal ku i-faqqez (*mı̄şa) kelb
 Kemal be.3M 3M-run.CAUS to dog
 ‘Kemal is making the dog run.’ (Yakut, 2013, 34b)

Turning to the periphrastic causative embedded under the verb ‘give, we see that GiveC allows the causee to be introduced only as a PP headed by *mı̄şa* ‘to, for’. The embedded verb is in infinitival form. Consider (361).

- (361) a. ado dolab-ad-en *mı̄şa tamirci* addil
 gave.3PL shelf-PL-their to repairman fix.INF
 ‘They had the repairman fix their shelves.’
 (Lit: They gave their shelves to the repairman to fixing)
- b. imm-a *mı̄şa fatma* ſi adıd-u addil
 mother-her to Fatma food gave-it.M fix.INF
 ‘Her mother had Fatma cook the food.’⁵⁴
 (Lit: The food, her mother gave it to Fatma to fixing) (Erguvanlı-Taylan, 2017, 221:30)

This construction is calqued on the Kurdish periphrastic causative (Akkuş, 2017; Akkuş and Benmamoun, 2018), which also uses the verb *bıdın* ‘give’, illustrated in (362).

⁵⁴Note that the causee and the theme in this example are preposed, which is not the basic word order in this construction. I discuss the derivation of this example in footnote 59 after I investigate the basic order.

- (362) mî piskilet do çekir-m-e
 I.OBL bicycle gave repair-INF-OBL
 ‘I had the bicycle repaired’

(Lit: I gave the bicycle to repairing) (Kurdish; Atlamaz, 2012, 62)

I argue that both geminates and ‘give’ causatives (GiveC) embed a second, embedded VoiceP; however, this VoiceP exhibits properties that warrant identifying it as a distinct type. I identify this type, which may also exhibit an active-passive alternation, as *CauseeP*. In geminate causatives, the causee may be generated as a DP in Spec,CauseeP. Alternatively it may also be introduced as a PP, or existentially closed. I arrive at this conclusion by applying some of the diagnostics from the ‘make’ causatives, such as secondary predicate licensing, sluicing, nonpassivizable idioms, passivization facts and the type of θ -role the causee is assigned. The structures for an active and passive CauseeP are illustrated in (363) and (364), respectively.

(363) **Active CauseeP**

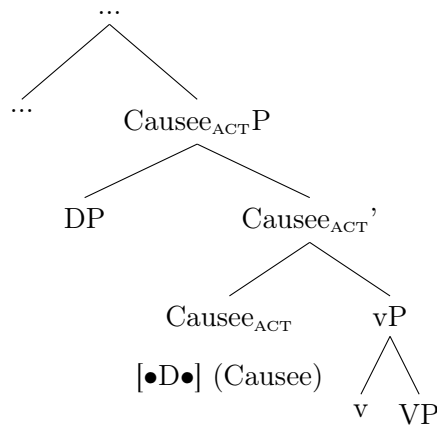

(364) **Passive CauseeP**

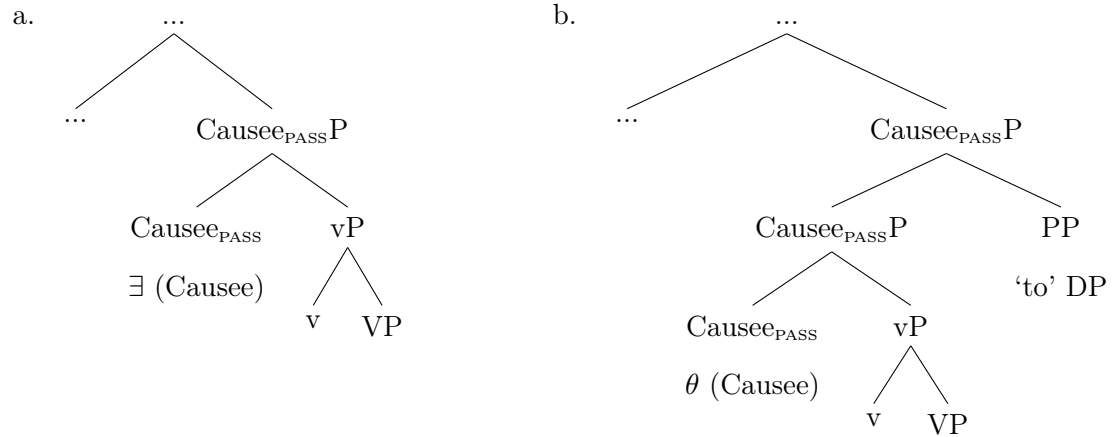

The GiveC, on the other hand, embed only the latter configuration, i.e., a passive CauseeP in (364). Furthermore, the two constructions differ in (at least) one important aspect. Geminates disallow the introduction of an applied argument in the embedded structure, whereas this is permitted in ‘give’-causatives. I capture this via the bundling of Causee⁰ and Appl⁰ in the gemination strategy. As such, the same argument bears two θ -roles in the geminates, whereas these heads are separate in the ‘give’-causatives (in the sense of Pylkkänen 2008; Harley 2017a). This provides an important diagnostic that can be applied to causative constructions crosslinguistically to help determine the status of the causee and its projection.

This section investigates the properties of geminate causatives and ‘give’-causatives (GiveC) that apply to transitive bases.

3.3.1 Active-passive alternation

A variety of diagnostics demonstrate that geminates exhibit an active-passive alternation (similar to ‘make’-causatives) and that the GiveC behaves as passives.

An initial clue with regard to the structure of geminate-causatives comes from *passivization asymmetries*. Recall that gemination allows the causee to be expressed either as a DP or a PP. This is illustrated in (365) (cf. (357)).

- (365) a. kemal ku i-qri lala kitab.
 kemal be.3M 3M-read.IPFV this.M book
 ‘Kemal is reading this book.’
- b. oretman ki tı-qarri *kemal* lala kitab.
 teacher be.3F 3F-read.CAUS Kemal this.M book
 ‘The teacher is making Kemal read this book.’ (Yakut, 2013, 33a)
- c. oretman ki tı-qarri lala kitab *mışa kemal*.
 teacher be.3F 3F-read.CAUS this.M book to Kemal
 ‘The teacher is making Kemal read this book.’ (Yakut, 2013, 33b)

Examples in (366) illustrate the behavior in cases where the causee is realized as a DP. As seen in (366c), it is the DP causee that raises to become the grammatical subject. However, raising the theme leads to ungrammaticality, (366d).

- (366) a. leyla qar-e alu kitabad
 Leyla read.PST-3F these.M books
 ‘Leyla read these books.’
- b. qarri-tu leyla alu kitabad
 read.CAUS-1SG Leyla these.M books
 ‘I made Leyla read these books.’
- c. leyla in-qarr-e [_ alu kitabad] (mı oratman)
 Leyla PASS-read.CAUS-3F [these.M books] (by teacher)
 ‘Leyla was made to read these books by the teacher.’
- d. *alu kitabad in-qarr-o [leyla _] (mı oratman)
 these.M books PASS-read.CAUS-3PL [Leyla] (by teacher)
Intended: ‘The books were made (by the teacher) to be read by Leyla.’

When the causee is a PP, (367a), the theme argument ends up as the grammatical subject, as such shows verbal agreement, (367b). The contrast between 366 and 367 shows that the higher embedded DP argument raises to become the promoted subject.

- (367) a. qarri-tu alu kitabad *mışa leyla*
 read.CAUS-1SG these.M books to Leyla
 ‘I made Leyla read these books.’

- b. *alu kitabad in-qarr-o* [_ *mı̄ṣa leyla*] (*mı̄ oratman*)
 these.M books PASS-read.CAUS-3PL [to Leyla] (by teacher)
 ‘These books were made (by the teacher) to be read by Leyla.’⁵⁵

The GiveC patterns like the geminates with a PP causee, in that it is only the theme argument that can be raised to become the grammatical subject; thus (368) and (369).

- (368) a. *im-mu ade xassil alu potad mı̄ṣa kemal*
 mother-his gave.3F wash.INF these clothes to Kemal
 ‘His mother made Kemal was these clothers.’
- b. *alu potad im-mu ad-id-en xassil mı̄ṣa kemal*
 these clothes mother-his gave-3F-3PL wash.INF to Kemal
 ‘These clothes, his mother made Kemal wash them.’
- c. **mı̄ṣa kemal, im-mu ad-id-u xassil alu potad*
 to Kemal mother-his gave-3F-3M wash.INF these clothes
 Intended: ‘To Kemal, his mother made him wash these clothes.’
- (369) a. *ams adi-tu dolab-ad-i mı̄ṣa tamirci addil*
 yesterday gave.3PL shelf-PL-my to repairman fix.INF
 ‘Yesterday, I had my shelves fixed by the repairman.’
- b. *ams dolab-ad-i in-ado mı̄ṣa tamirci addil (mı̄-nni)*
 yesterday shelf-PL-my PASS-gave.3PL to repairman fix.INF by-me
 ‘Yesterday I made the repairman fix my shelves.’
 (‘Yesterday, my shelves were made fixed by the repairman by me’)
- c. **ams (mı̄ṣa) tamirci in-ada dolab-ad-i addil (mı̄-nni)*
 yesterday (to) repairman PASS-gave.3M shelf-PL-my fix.INF by-me
 ‘I made the repairman fix my shelves yesterday.’
 (Intended: ‘Yesterday, the repairman was made fix my shelves by me’)

Note that this contrast is informative, but does not necessarily indicate an active-passive alternation. Many languages with double-object versus dative-shift for ditransitives, including English, exhibit the same asymmetry. SA also has the same hierarchy effect in ditransitives. In a ditransitive DP-DP configuration, as in (370), only the higher DP can

⁵⁵See e.g. Camilleri et al. 2014 for the same restriction in ditransitives in other Arabic varieties such as Egyptian Arabic, Hijazi Arabic and Maltese.

be passivized. ($DP_{IO} > DP_{DO}$ is the base order based on the classic diagnostics such as binding, etc).

(370) ditransitives DP-DP

- a. kemal qal leyla alu şıylad.
Kemal told.3M Leyla these.M gossips
'Kemal told Leyla these pieces of gossip.'
- b. leyla m-qal-e (mı kemal) _ alu şıylad.
Leyla PASS-told-3F by Kemal these.M gossips
'Leyla was told (by Kemal) these pieces of gossip.'
- c. *alu şıylad m-qal-o (mı kemal) leyla _.
these.M gossips PASS-told-3PL by Kemal Leyla
'These pieces of gossip were told (by Kemal) Leyla.'

On the other hand, in a ditransitive DP-PP configuration, only the DP theme can be passivized, (371b), and raising the indirect object leads to ungrammaticality, (371c).

(371) ditransitives DP-PP

- a. kemal qal alu şıylad mışa leyla.
Kemal told.3M these.M gossips to Leyla
'Kemal told these pieces of gossip to Leyla.'
- b. alu şıylad m-qal-o (mı kemal) _ mışa leyla.
these.M gossips PASS-told-3PL by Kemal to Leyla
'These pieces of gossip were told (by Kemal) to Leyla.'
- c. * (mışa) leyla m-qal-e (mı kemal) alu şıylad.
(to) Leyla PASS-told-3F by Kemal these.M gossips
'Leyla was told (by Kemal) these pieces of gossip.'

Against this backdrop, I employ other diagnostics for the active-passive alternation in the geminates and the passive structure for the GiveC, and the adjunct status of the PP. The evidence comes from (i) the interpretation in the absence of the causee, (ii) sluicing, (iii) nonpassivizable idioms, and (iv) secondary predicates.

3.3.1.1 The interpretation of the null causee

The causee is optional, and is interpreted as existential (like a missing ‘by’-phrase) rather than pronominal (like a *pro*-dropped argument). Consider (372).

- (372) leyla qarr-e alu kitabad.
 Leyla read.CAUS.PFV-3F these.M books
 YES: ‘Leyla made *someone* read these books.’
 NO: ‘Leyla made *him/her/them* read the books.’

The interpretation of the null causee as existential also explains the grammaticality of (373a) only in the absence of a DP causee. The absence of a DP causee indicates that it is not projected, which in turn allows the theme argument to be raised. The raising of the theme is possible regardless of whether a PP causee is realized or not, (373b), in line with the adjuncthood status of the PP (to be motivated more anon).

- (373) a. alu kitabad in-qarr-o [(*Leyla) _] (m1 oratman)
 these.M books PASS-read.CAUS-3PL [(*Leyla)] (by teacher)
 ‘The books were made (by the teacher) to be read by Leyla.’
 b. alu kitabad in-qarr-o [_ (mıřa leyla)] (m1 oratman)
 these.M books PASS-read.CAUS-3PL [(to Leyla)] (by teacher)
 ‘The books were made (by the teacher) to be read (by Leyla).’

Another piece of evidence for the observation is that a pronoun in a following clause cannot refer to the implicit causee, whereas it can refer to an overt DP causee.

- (374) a. xassal-tu nesma_i araba. *pro*_i boř bacarikli kan.
 washed.CAUS-1SG someone car very talented aux.PST.3M
 ‘I made someone_i wash the car. He_i was very talented.’
 b. xassal-tu araba *e*_i. #*pro*_i boř bacarikli kan.
 washed.CAUS-1SG car very talented aux.PST.3M.
 ‘I had the car washed *e*_i. #He_i was very talented.’

The adjuncthood status of the PP is also supported by clefting: similar to e.g. Uzbek (Gribanova 2013), Turkish (see Chapter 4), Egyptian Arabic (Soltan 2019), only arguments

can be clefted, and adjuncts are not licit cleft pivots in SA. This is illustrated in (375) for a grammatical subject *versus* the ‘by’-phrase of a short passive

- (375) a. ina kittu ande le adaş sabi-ma.
 I aux.PFV.1SG who that saw.3M boy-a
 ‘It was me who saw a boy.’
- b. *mı inā kan ande le in-adaş sabi-ma.
 by me aux.PFV.3M who that PASS.PFV-saw.3M boy-a
 ‘It was by me that a boy was seen.’

Examples in (376) demonstrate that while a DP causee can be clefted, a PP causee cannot be.

- (376) a. ina kittu ande le leyla qarr-e _ alu kitabad.
 I aux.PFV.1SG who that Leyla read.CAUS-3F these.M books
 ‘It was me that Leyla made read these books.’
- b. *mışa inā kan ande le leyla qarr-e alu kitabad _.
 to I aux.PFV.3M who that Leyla read.CAUS-3F these.M books
 ‘It was by me that Leyla made these books be read.’

Note that in SA there is not a ban against clefting of prepositional phrases. For instance, the PP argument of the verb ‘to put’ can be clefted, (377a), whereas the PP adjunct in (377b) cannot be.

- (377) a. fo mase kan (amma) le hatti-tu potad _.
 on table aux.3M where that put.PFV-1SG clothes
 ‘It was on the table that I put the clothes.’
- b. *fo mase kan (amma) le nam-tu _.
 on table aux.3M where that slept-1SG
 ‘It was on the table that I slept.’

The same interpretation is observed in the GiveC, as such the absence of the PP causee leads to an existential reading, (378).⁵⁶

⁵⁶Note that a null recipient in ditransitives is interpreted as a pronominal rather than existential, pointing to a structural difference between causatives and ditransitives.

- (378) a. ams dolab-ad-i in-ado mışa tamirci addil mi-nni
 yesterday shelf-PL-my PASS-gave.3PL to repairman fix.INF by-me
 ‘Yesterday my shelves were made by me to be fixed by the repairman.’
- b. cf. ams dolab-ad-i in-ado addil mi-nni
 yesterday shelf-PL-my PASS-gave.3PL fix.INF by-me
 ‘Yesterday my shelves were made by me to be fixed (by someone /#by him).’

3.3.1.2 Sluicing

As discussed in section 3.2.2.2, in line with Merchant’s (2013), in SA as well VP ellipsis may allow voice mismatching, sluicing does not.

- (379) sluicing
- a. kitab in-qara, hama m-o-re *(m₁) ande
 book PASS-read.3M but NEG-1SG-know *(by) who
 ‘The book was read, but I don’t know *(by) who.’
- b. sadqe boş samaq in-qafal-o, hama mi-arafe *(m₁) ande
 believed.3F many fish PASS-caught-3PL, but NEG-knew *(by) who
 ‘She believes many fish to have been caught, but she didn’t know *(by) who.’

Note that an implicit agent can license sluicing, (379a), but a null pronoun (*pro*-dropped argument) cannot, (380).⁵⁷

- (380) a. fada babe wara mifta.
 opened.3M door with key
 ‘(He) opened the door with a key.’ ← *requires established topic*

-
- (i) ams adi-tu potad-i.
 yesterday gave-1SG clothes-my
 ‘Yesterday I gave *him/her/them* my clothes.’

Another contrast between the Causee and IO in ditransitive is that an overt causee can license depictives (see §3.3.1.4), whereas an IO cannot.

- (ii) varr-e Kamal xabar {*raxu / raxu-e}
 showed-3F Kemal.M news {sick.M / sick-F}
 ‘She₁ showed Kemal₂ the news sick_{1/*2}.’

⁵⁷Given that the null causee is interpreted existentially (cf. Sect 3.3.1.1), the following arguments also follow from an active-passive alternation, and not two different argument structures. Thanks to Benjamin Bruening (p.c.) for this point.

(Someone) opened the door with a key.

The door was opened with a key.

- b. fada babe wara mifta, #hama mī-arafe ande
opened.3M door with key, but NEG-knew-3F who
'(He) opened the door with a key, #but she didn't know who.'

Turning to geminates, we observe that the embedded structure with a DP causee behaves like a canonical active for sluicing, (381), such that the remnant cannot be headed by a preposition.

- (381) leyla qarr-e nes-ma alu kitabad, hama m-o-re (*mīṣa) ande
Leyla read.CAUS-3F person-a these.M books, but NEG-1SG-know to who
'Leyla made someone read these books, but I don't know who.'
(Leyla caused a person to read these books, *but I don't know by whom)

With a PP causee, the embedded clause behaves as passive for sluicing, (382).

- (382) a. leyla xassal-e alu potad, hama m-o-re *(mīṣa) ande
Leyla wash.CAUS-3F these.M clothes, but NEG-1SG-know to who
'Leyla had these clothes washed, but I don't know by who.'
- b. leyla qarr-e alu kitabad mīṣa nes-ma, hama m-o-re
Leyla read.CAUS-3F these.M books to person-a, but NEG-1SG-know
*(mīṣa) ande
to who
'Leyla had these books read by someone, but I don't know by who.'
(Leyla caused these books to be read by someone, *but I don't know who.)

Expectedly, in the GiveC, the embedded clause behaves as passive.

- (383) leyla ad-e alu kitabad (mīṣa nes-ma) qaru, hama m-o-re
Leyla gave-3F these.M books (to person-a) read.INF, but NEG-1SG-know
*(mīṣa) ande
to who
'Leyla had these books read by someone, but I don't know by who.'

It is indeed possible to have different interpretations in the GiveC depending on whether sluicing targets the main clause or the embedded clause, as shown in (384). In (384a), the

remnant *mı ande* “by who” indicates that the sluice can only target the matrix clause, an impersonal passive, not the caused event “build”. In, (384b), the remnant *mışa ande* “to who” indicates that it can only target the caused event “build” in the complement of “give”. Note that in either interpretation, leaving out the preposition on the remnant results in ungrammaticality. Consider (384c).

- (384) a. *m-ada beyt mışa nes-ma addil, hama m-ore mı ande*
 PASS-gave house to person-a build.INF but NEG-know.1SG by who
 ‘It was made someone build the house, but I don’t know by who’
 YES: who made somebody build the house
 NO: who built the house
- b. *m-ada beyt mışa nes-ma addil, hama m-ore mışa ande*
 PASS-gave house to person-a build.INF but NEG-know.1SG to who
 ‘It was made someone build the house, but I don’t know by who’
 YES: who built the house
 NO: who made somebody build the house
- c. *m-ada beyt mışa nes-ma addil, hama m-ore *(mışa / mı)*
 PASS-gave house to person-a build.INF but NEG-know.1SG (to / by)
ande
 who

The sluicing test demonstrates that geminates exhibit an active-passive alternation, whereas the GiveC behaves as passive for sluicing.

3.3.1.3 Nonpassivizable idioms

We can employ nonpassivizable idioms as a diagnostic for the active-passive alternation for these causative strategies as well. As mentioned in section 3.2.2.3, SA has a class of nonpassivizable idioms, repeated here as (385).

- (385) a. *kemal qaraf fayz le şeytan*
 Kemal broke.3M leg of devil
 ‘Kemal finally got lucky.’ (lit. broke the devil’s leg)

- b. fayz le şeytan m-qaraf mı kemal
 leg of devil PASS-broke.3M by Kemal
 ‘The devil’s leg was broken by Kemal.’
 ‘*Kemal finally got lucky.’

These idioms may occur in geminates only in the case of a DP causee, (386a), but not a PP causee, (386b).

- (386) a. nihayet qarrıf-tu kemal fayz le şeytan
 finally broke.CAUS-1SG Kemal leg of devil
 ‘I finally made Kemal get lucky.’ (lit. broke the devil’s leg)
- b. nihayet qarrıf-tu fayz le şeytan (mışa kemal)
 finally broke.CAUS-1SG leg of devil to Kemal
 ‘I finally had the devil’s leg broken by Kemal.’
 NOT: Kemal finally got lucky.

The same idioms are also not possible in the GiveC, (387).

- (387) adi-tu fayz le şeytan (mışa kemal) qarf
 gave.CAUS-1SG leg of devil to Kemal break.INF
 ‘I finally had the devil’s leg broken by Kemal.’
 NOT: Kemal finally got lucky.

Idioms of this sort contrast with passivizable idioms, (388).

- (388) a. kemal hatarax ro-i
 Kemal burned.3M heart-my
 ‘Kemal broke my heart.’
 Lit: ‘Kemal burned my heart.’
- b. ro-i m-hatarax mı kemal
 heart-my PASS-burned.3M by Kemal
 ‘My heart was broken by Kemal.’

Unlike non-passivizable idioms, which require a DP causee, such idioms impose no restriction; (254) for geminates and (390) for the GiveC.

- (389) a. *imm-u harray-e Leyla ro le Kemal*
 mother-his burned.CAUS-3F Leyla heart of Kemal
 ‘His mother made Leyla break Kemal’s heart.’
- b. *imm-u harray-e ro le Kemal (mıřa Leyla)*
 mother-his burned.CAUS-3F heart of Kemal to Leyla
 ‘His mother had Kemal’s heart be broken (by Leyla).’
- (390) *imm-u ad-e ro le Kemal (mıřa Leyla) harx*
 mother-his gave-3F heart of Kemal to Leyla burn.INF
 ‘His mother had Kemal’s heart be broken (by Leyla).’

The contrast between passivizable and non-passivizable idioms demonstrate that geminates with a DP causee behave as active, thus are compatible with nonpassivizable idioms, whereas those with a PP causee behave as passive, thus are not. The PP causee in the GiveC patterns like its geminate counterpart.

3.3.1.4 Secondary Predicates

Recall that in SA depictives require a projected binder, as repeated in (391).⁵⁸

- (391) a. *nes-ma_i amal araba (sarxoř_i).*
 person-a drove car (drunk)
 ‘Someone_i drove the car drunk_i.’
- b. *araba m-amal-e (řsarxoř)*
 car.F PASS-drove-F (řdrunk)
 ‘The car was driven drunk.’

Secondary predicates are compatible with geminates only when the causee is a DP, (392). Note that in (392b), Clitic Left Dislocation (CLLD) is used to control for how the causee is introduced.

- (392) *Geminates*
- a. *Depictives Possible with DP causee*

⁵⁸For some speakers, the presence of a ‘by’-phrase significantly improves the possibility of depictives in passives.

nana_i qarri-na kemal_k kitab-na (sarxoş_{i/k}).
 we read.CAUS-1PL Kemal book-our (drunk)

‘We made Kemal read our book drunk.’

b. *Depictives Impossible with null causee*

haşış nana_i hammıl-na-u e_k (sarxoş_{i/??k}).
 grass we carried.CAUS-1PL-3M (drunk)

‘The grass, we made someone carry it drunk.’

c. *Depictives Impossible with PP causee*

nana_i hammıl-na haşış mışa işçiyad (sarxoş_{i/??k}).
 we carried.CAUS-1PL grass to workers_k (drunk)

‘We made the workers carry the grass drunk.’

On the other hand, depictives are not licensed with the GiveC, (393).

(393) *GiveC: Depictives Impossible*

a. nana_i mı-na-di daq ziyar-na e_k (sarxoş_{i/??k}).
 we NEG-1PL-give beat.INF children-our (drunk)

‘We don’t let anyone beat our children drunk.’

b. beaql ye dar hamıl haşış (??bitkin).
 unwise cop.3SG give carry.INF grass (??tired)

‘It would be unwise to make someone carry the grass tired.’

The diagnostics in this section demonstrate the existence of an active-passive-like alternation for geminate causatives, similar to “make” causatives, and a passive structure for the GiveC.⁵⁹ The DP causee is an argument, whereas the PP causee in both geminates and the GiveC is an adjunct like a ‘by’-phrase.⁶⁰ Given the active-passive-like alternation,

⁵⁹ Similar to ‘make’-causatives, “give” causatives and the GiveC also lack the full CP layer in the embedded structure, illustrated, for example, by the unavailability of CLLD to the right of ‘give’, as in (i).

(i) *ams aya ada haşış mışa işçiyad hazd-u.
 yesterday landlord gave.3M grass to employees cut.INF-it.M
 ‘Yesterday the landlord made the grass, the workers cut it.’

This contrasts with (361b), in which the theme is CLLD-ed to the left of the causativizing verb, presumably somewhere in CP. Note also the scrambling of the causee.

⁶⁰It is a non-trivial question why GiveC has only the passive ApplP, and not the active one. Note that same pattern is also observed in Austronesian languages (Rackowski and Richards 2005; Legate 2014); for

a straightforward conclusion to draw is the presence of a canonical VoiceP. However, the next section contends that this VoiceP differ from the canonical VoiceP, e.g., the VoiceP in ‘make’-causatives, in several respects, as such calls for identifying it as a separate category.

3.3.2 The causee is not in VoiceP

In light of the active-passive-like alternation, a straightforward conclusion to draw would be the presence of VoiceP. However, this section contends that the causee is introduced in a separate category than the canonical Voice⁰, which we identify as CauseeP. Therefore, the geminates and GiveC differ from ‘make’-causatives, which embeds an agentive, thematic VoiceP.

The CauseeP assigns a different θ -role (causee versus initiator); as such (i) instrument phrases, (ii) agent-oriented adverbs, or (iii) agent-oriented comitatives cannot be associated with the embedded causee. Moreover, (iv) the causee is introduced with a different preposition than canonical agents are. I compare the properties of geminates and the GiveC with those of ‘make’-causatives.

3.3.2.1 Instrument phrases

Recall that being a diagnostic for an external argument layer (i.e. Voice), instrumentals are licit in passives, but not in unaccusatives/inchoatives. Moreover, they are also grammatical in ‘make’-causatives, and can modify the embedded agent, (394).

instance, several cases of applicatives (Acehnese causees included) for which the active applicative is only possible if Voice is passive (or object voice), but the passive applicative is unrestricted. This asymmetry might be because an active phrase requires licensing of an additional argument, whereas the passive projection does not.

Note also that the possibility of whether the morphological difference between geminates and the GiveC cannot be connected to a syntactic difference, with the latter only having the passive structure. Although it would be an interesting hypothesis, it would not work when we take ‘make’-causatives into consideration. Although both the GiveC and ‘make’-causatives are periphrastic causatives, ‘make’-causatives pattern like the geminates in allowing active-passive alternation. It could be a selection issue, as such the causativizing verb may select for a specific type of voice. This predicts crosslinguistically the existence of causative constructions which embed only an active structure. However, causatives are not usually described in these terms, and future research might reveal that this is indeed possible. An investigation of this sort would take us too far afield.

- (394) a. si-to ayet şurvan wara ibre
 made-2PL sew.INF pants with needles
 ‘You had someone [sew the pants with needles].’
- b. kemal sa buay sir glimboz-e wara sope.
 Kemal made.3M paint do.INF turtle-F with stick
 ‘Kemal, with the stick, had [someone paint the turtle].’
 ‘Kemal had [someone paint the turtle with the stick].’

On the other hand, instrumentals pick out only the causer in both the geminates, (395), and the GiveC, (396).

- (395) a. im-mu xassle hasan potad wara furça gbir-e
 mother-his washed.CAUS.3F Hasan clothes with brush big-F
 ‘His mother made Hasan wash the clothes with a big brush.’
 YES: His mother used the brush [to force Hasan to do washing possibly with another instrument].
 NOT: Hasan used the brush.
- b. im-mu xassle potad mişa hasan wara furça gbir-e
 mother-his washed.CAUS.3F clothes to Hasan with brush big-F
 ‘His mother made Hasan wash the clothes with a big brush.’
 YES: His mother used the brush ...
 NOT: Hasan used the brush.
- (396) im-mu ade lalu potad mişa hasan xassil wara furça gbir-e
 mother-his gave.3F these clothes to Hasan wash with brush big-F
 ‘His mother made Hasan wash the clothes with a big brush.’
 YES: His mother used the brush ...
 NOT: Hasan used the brush.

Instrumental phrases manifesting gender distinction are in line with the above generalization. In (397a), the instrument containing the feminine possessor refers to the matrix causer. In (397b), however, the instrumental contains a phrase with masculine possessor, and cannot have a meaning in which Hasan used his own arms to do the washing, although this is logically possible.

- (397) a. *im-mu xassle hasan potad wara hass-a saqqil.*
 mother-his washed.CAUS.3F Hasan.M clothes with voice-her heavy
 ‘His mother made Hasan wash the clothes with her imposing voice.’
- b. *im-mu xassle hasan_i potad wara kittaf-u*_{i/k} ziyim-in.*
 mother-his washed.CAUS.3F Hasan.M clothes with arms-his strong-PL
 ‘His mother made Hasan_i wash the clothes with his*_{i/k} strong arms.’
- YES: The mother used someone else’s strong arms (metaphorically) to force Hasan to do the washing.
- NO: Hasan used his arms to do the washing.

3.3.2.2 Agent-oriented adverbs

Agent-oriented adverbs in SA provide another testing ground with respect to the θ -role the external argument of the embedded event bears (Ernst 2001; Matsuoka 2013, i.a.). As mentioned earlier, these adverbs can modify the action of the embedded agent in ‘make’-causatives, (398).

- (398) *bolum tı-si mez sınavad le qabul wara diqqat.*
 department 3F-make look.INF tests of acceptance with care
 ‘The department makes (someone) [check acceptance tests carefully].’

On the other hand, agent-oriented adverbs cannot be associated with the causee in either geminates, (399), or the GiveC, (400); they exclusively target the causer.

- (399) a. *oratman ki tı-qarri kemal lala kitab bı sabır*
 teacher be.3F 3F-read.CAUS Kemal this.M book with patience
 ‘The teacher is making Kemal read this book patiently.’
- YES: The teacher is patient.
- NOT: Kemal is patient.
- b. *oratman ki tı-qarri lala kitab mışa kemal bı sabır*
 teacher be.3F 3F-read.CAUS this.M book to Kemal with patience
 ‘The teacher is making Kemal read this book patiently.’
- YES: The teacher is patient.
- NOT: Kemal is patient.

(400) im-mu ade lalu potad mışa kemal xassil bı sabır
 mother-his gave.3F these clothes to Kemal wash.INF with patience
 ‘His mother made Kemal wash these clothes patiently.’

YES: His mother was patient.

NOT: Kemal was patient.

3.3.2.3 Agent-oriented comitatives

Recall that the comitative reading is also available in ‘make’-causatives, (401), thus pointing to the presence of a canonical Voice layer.

(401) kemal sa hamıl mase wara hasan
 Kemal made carry.INF table with Hasan
 ‘Kemal made someone carry the table with Hasan.’

(Hasan helped carry the table)

In the case of geminates and the GiveC, however, the comitative reading is not available with the causee, but only with the matrix causer.

(402) a. leyla hamıl-e kemal mase wara hasan
 Leyla carried.CAUS-3F Kemal table with Hasan
 ‘Leyla made Kemal carry the table with Hasan.’

YES: Leyla and Hasan made Kemal carry the table.

NO: Leyla made Kemal and Hasan carry the table

b. leyla hamıl-e mase mışa kemal wara hasan
 Leyla carried.CAUS-3F table to Kemal with Hasan
 ‘Leyla made Kemal carry the table with Hasan.’

YES: Leyla and Hasan made Kemal carry the table.

NO: Kemal and Hasan carried the table

(403) leyla ade mase mışa kemal hamıl wara hasan
 Leyla gave table to Kemal carry.INF with Hasan
 ‘Leyla made Kemal carry the table with Hasan.’

YES: Leyla and Hasan made Kemal carry the table.

NO: Kemal and Hasan carried the table

To summarize, agent-oriented adverbs, instrumentals and agent-oriented comitatives systematically fail to be associated with the caused event both for the geminates and the GiveC.

3.3.2.4 Choice of the preposition

Another aspect that distinguishes the Causee from the canonical VoiceP Initiator relates to the choice of the preposition heading the PP adjunct. The PP adjunct in both short passives and ‘make’-causatives are headed by the preposition *mi* ‘by, from’, (240).

- (404) a. *ala cam mi kemal in-qaraf b1-l-qasti.*
 this glass *by Kemal* PASS-broke.3M with-the-intention
 ‘This glass was broken by Kemal deliberately.’
- b. *kemal sa xassil potad mi mara-ma pir-e.*
kemal made.3M wash.INF clothes *by woman-a old-F*
 ‘Kemal had the clothes washed by some old woman.’

However, as seen throughout, and illustrated again below, the PP adjunct causee in both geminates, (405a), and the GiveC, (405b), is headed by preposition *mısa* ‘to, for’.

- (405) a. *oretman ki tı-qarri lala kitab mısa kemal.*
 teacher be.3F 3F-read.CAUS this.M book to Kemal
 ‘The teacher is making Kemal read this book.’
- b. *ams adi-tu dolab-ad-i mısa tamirci addil.*
 yesterday gave-1SG shelf-PL-my to repairman fix.INF
 ‘Yesterday, I had my shelves fixed by the repairman.’

These diagnostics show that although the embedded event involves an active-passive alternation in the geminates, and a passive configuration in the GiveC, this embedded projection assigns a different θ -role (causee versus initiator) than the canonical VoiceP. I propose the structures for the geminates and the GiveC in the next section, which are both argued to embed a CauseeP.

3.3.3 Proposal: CauseeP and bundling with ApplP

I argue that an analysis of passive along the lines of Legate’s (2014) could be extended to the gemination and the GiveC strategies in SA. This hypothesis correctly predicts the properties of these two constructions and explains their contrast with ‘make’-causatives. As opposed to a generalized demotion head/operation, Legate (2014) proposes an alternative analysis of passive, in which the passive is a variant of a functional head that introduces a DP in its specifier, a configuration that could be attested in other functional heads, e.g. Appl⁰ (cf. oblique causers in Pykkänen 2008).

One prediction of this analysis is that an active-passive-like alternation also should be possible on a functional head other than Voice as long as the language in question allows the existential closure to apply to that head and has a PP with the right semantics. Moreover, similar to its Voice counterpart in certain circumstances, this passivization does not necessarily end up with a morphological reflex (e.g. Harley 2017b; Pitteroff 2014, 2015). We have already seen that geminates and the GiveC in SA manifest an active-passive alternation. However, the relevant functional category exhibits properties that warrant identifying it as a distinct projection than canonical VoiceP. We identify this functional category as CauseeP. Let us illustrate structures with the active CauseeP and two possible configurations of passive CauseeP.

An illustration of the active CauseeP for the geminate causative is given in 406. The causee ‘Leyla’ is generated as a DP in Spec,CauseeP, and becomes the grammatical subject when passivized. It receives a causee θ -role from Causee⁰, as in 406b (leaving out *v*).

(406) *Active CauseeP*

- a. qarri-tu leyla alu kitabad
 read.CAUS-1SG Leyla these.M books
 ‘I made Leyla read these books.’

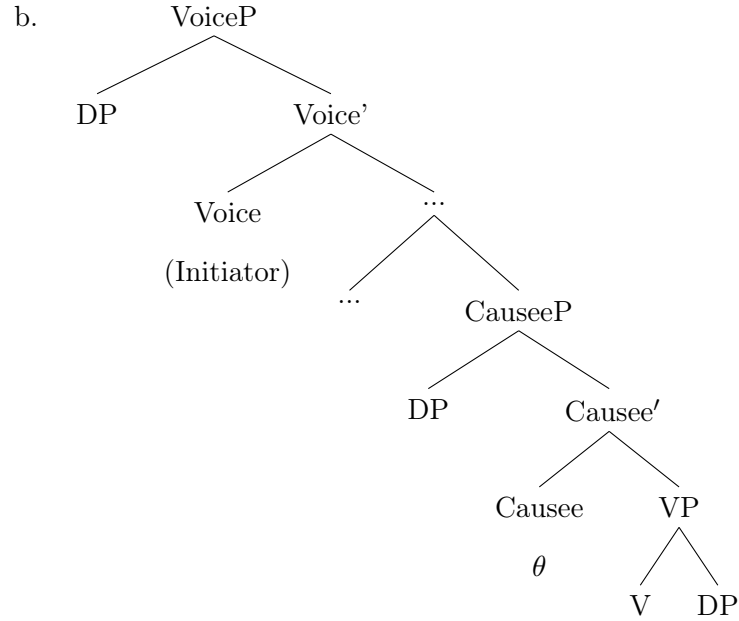

Alternatively, the Causee may be introduced like the initiator in the canonical passive, which has two associated semantic denotations (see also Bruening 2013; Alexiadou et al. 2015; Legate 2014 as well as Chapter 1).

In the denotation with a PP adjunct, $\text{Causee}_{\text{PASS}}$ leaves the causee position open, i.e. $\lambda e.\lambda x.\text{CAUSEE}(x,e)$, to be accessed and saturated by the ‘to’-phrase. P assigns a causee θ -role to its DP complement, this causee being tied semantically to the causee θ -role introduced by Causee^0 , as in 407.

(407) *Passive CauseeP with ‘to’-phrase*

- a. qarri-tu alu kitabad mışa leyla
 read.CAUS-1SG these.M books to Leyla
 ‘I made Leyla read these books.’

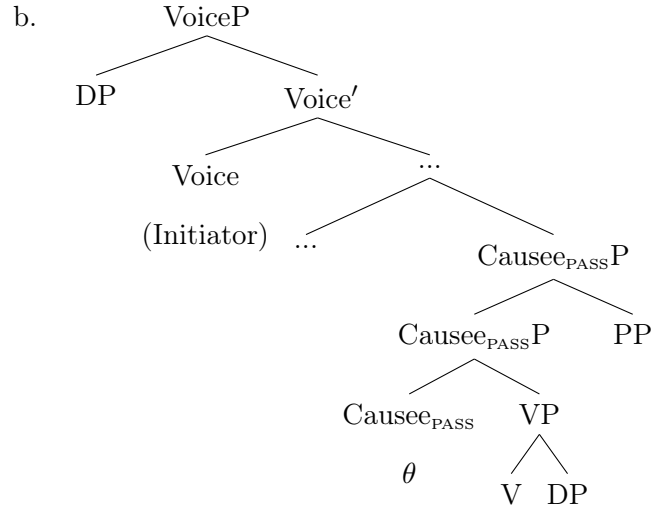

The semantic denotation of the caused event, in which the causee position is saturated by the ‘to’-phrase, is provided in 408 (see Bruening 2013 for the denotations).

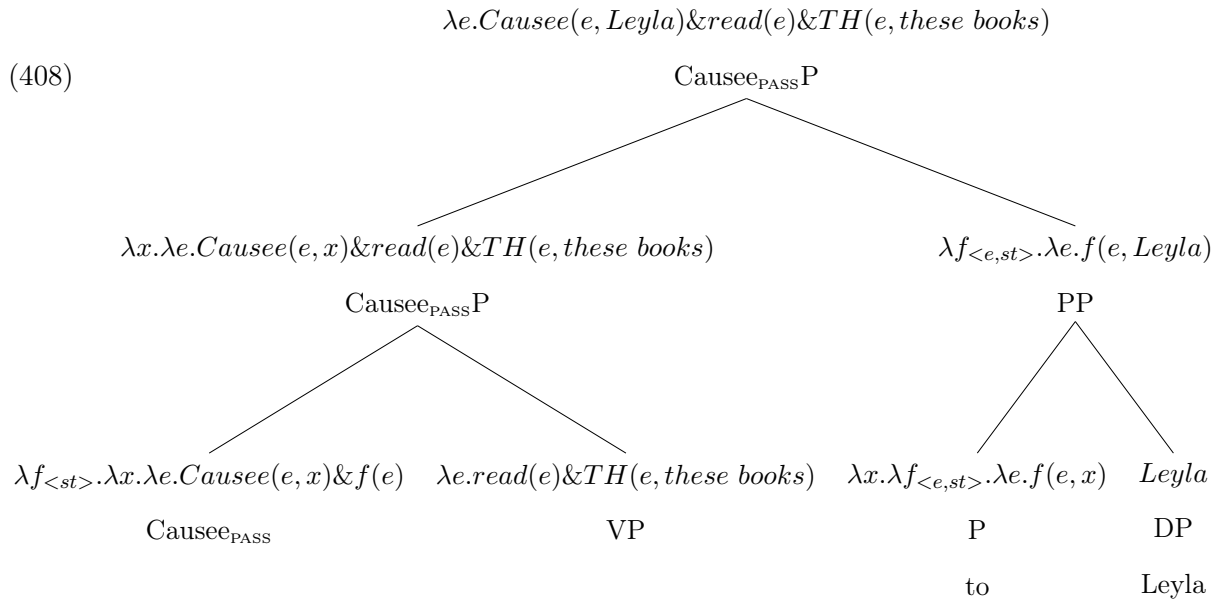

In the second denotation, in which passive CauseeP does not combine with a ‘to’-phrase, the causee is existentially bound on the Causee_PASS head, thus $\lambda e.\exists x.CAUSEE(x, e)$, as in (409).

(409) *Passive CauseeP without ‘to’-phrase*

- a. qarri-tu alu kitabad
 read.CAUS-1SG these.M books
 ‘I had these books read.’

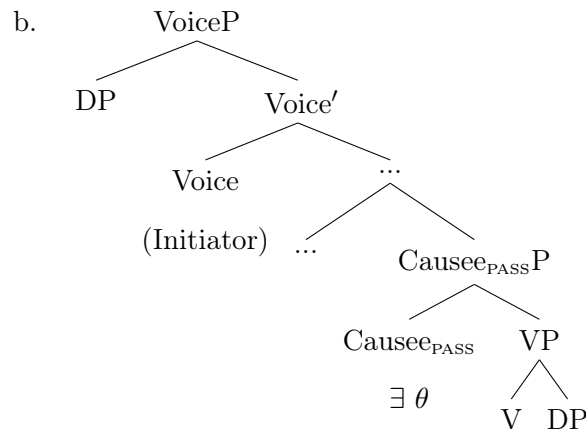

The relevant semantic denotation is provided in (410).

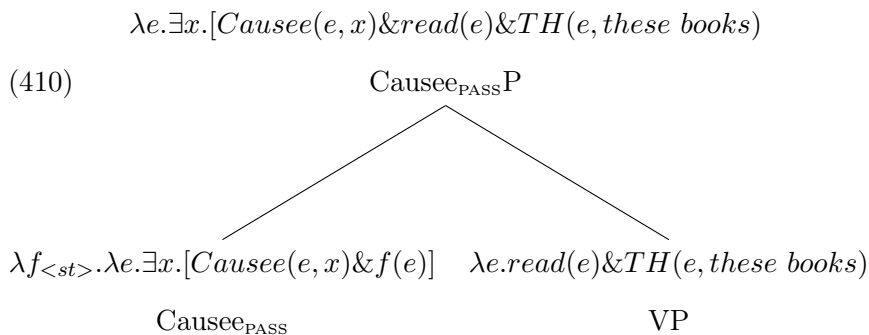

Therefore, geminate causatives that apply to transitive bases have active and passive CauseeP structures, as in (406b) through (409b). The GiveC, on the other hand, exhibits only the passive CauseeP configurations in (407b) and (409b).

These constructions differ from ‘make’-causatives, which embeds a thematic Voice⁰. Consider the illustration in (411) for the active embedded Voice.⁶¹

(411) *Active VoiceP in ‘make’-causatives*

⁶¹An analysis along the lines of Schäfer (2008); Wood (2015) cannot also be applied to the geminative causatives in SA. For example, Wood (2015, ch. 4) allows the introduction of a thematic role, i.e. an open semantic position, for active figure reflexives in Icelandic, without having a specifier position. Wood’s mechanism is very similar to the proposed mechanism for ‘make’-causatives. However, the motivations for adopting such an analysis do not carry over to the geminates or GiveC, since the absence of a ‘by’-phrase does not lead to an active structure, but a passive with an existentially interpreted implicit agent.

Another alternative analysis of Schäfer (2012) treats particular types of oblique causers as modifiers to a little *v* head introducing a causing event (embedded under Voice). However, I have demonstrated earlier that the Causee functions as an argument rather than a modifier in SA (in Chapter 4, I will argue that the same holds for Turkish causatives).

- a. aḡa sa addil beyt-ma.
 village.lord made.3SG build.INF house-a
 ‘The village lord made someone build a house.’

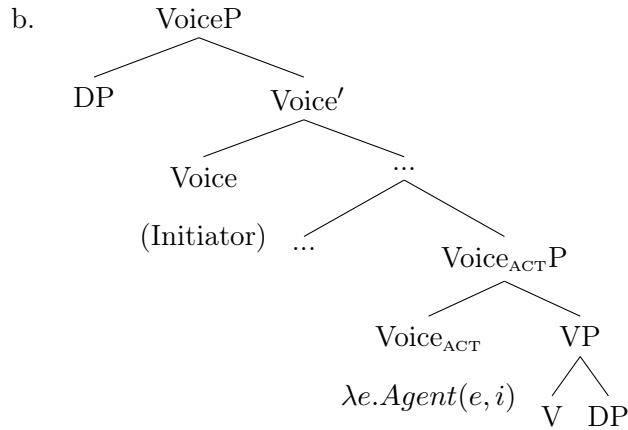

The discussion thus far demonstrates that geminates and the GiveC pattern alike in terms of embedding a CauseeP, and not a VoiceP. Further investigation reveals that geminates and the GiveC also differ regarding a significant aspect, i.e. co-occurrence with an applied argument. The next section demonstrates that whereas the GiveC and ‘make’-causatives permit the presence of an applicativized argument as well as the causee, geminates disallow applicatives.

3.3.4 Co-occurrence with an applied argument

In this section, we implement a diagnostic, i.e. the co-occurrence restrictions between the causee and applied arguments, to probe whether the causee is generated in ApplP (a relatively standard view, e.g. Ippolito 2000; Zubizarreta 1985; Legate 2014; Nash 2017). This diagnostic is based on the well-known generalization that most languages allow only one applied argument in a given clause (e.g. Marantz 1993; McGinnis 1998; Nie 2020; see also footnote 64), which is also true in Sason Arabic. On the basis of this background, we hypothesize that if the causee is introduced in ApplP, then no other applied argument should be possible. It turns out an applicative argument is allowed in some causative constructions, but not others.

Let us start by looking at benefactive applicatives in root clauses in SA (though the

same properties also hold in finite embedded clauses). The example in (412a) demonstrates that the applicative argument may occur with an unergative verb. It is also possible to introduce the beneficiary embedded under a PP adjunct, as in (412b).

- (412) a. kemal faqaz-*la* sari killu.
 Kemal ran.3M-her morning all
 ‘Kemal ran for her the whole morning.’
- b. kemal faqaz mişa-*na* / mişa leyla.
 Kemal ran.3M for-her / for Leyla
 ‘Kemal ran for her / Leyla.’

Examples in (413) and (414) illustrate the same pattern for the active and stative transitive predicates, ‘to read’ and ‘to hold’, respectively.⁶² The beneficiary can be introduced as a DP argument as well as a PP adjunct.

- (413) a. kemal ku i-qri lala kitab.
 Kemal PROG.3M 3M-read.IPFV this.M book
 ‘Kemal is reading this book.’
- b. kemal ku i-qri lala kitab mişa leyla.
 Kemal PROG.3M 3M-read.IPFV this.M book for Leyla
 ‘Kemal is reading this book for Leyla.’
- c. kemal ku i-qri-lla / i-qri leyla lala kitab.
 Kemal PROG.3M 3M-read.IPFV-her / 3M-read.IPFV Leyla this.M book
 ‘Kemal is reading her / Leyla this book.’ (same meaning as the b example)
- (414) a. kemal ku i-mseg ax-un ıstudi şamsiya.
 Kemal PROG.3M 3M-hold brother-his small umbrella
 ‘Kemal is holding his little brother the umbrella.’
- b. kemal ku i-mseg şamsiya mişa ax-un ıstudi.
 Kemal PROG.3M 3M-hold umbrella for brother-his small
 ‘Kemal is holding the umbrella for his little brother.’ (same meaning as the a example)

⁶²Note that some semantic factors are at play as to which arguments are most felicitous as applied arguments: clitics and full DPs that are large in phonological/syntactic size as well as related to the theme. A similar restriction is reported by Folli and Harley (2006) for Italian benefactives, whereby only certain arguments qualify as possible beneficiaries: clitics, and DPs closely related to the theme.

Recipients or goals are also possible in SA, as shown in (415).

- (415) kemal ada oranciyad zakk-in lala kitab.
Kemal gave.3M students intelligent-PL this.M book
'Kemal gave intelligent students this book.'

These examples confirm that the two types of applied arguments distinguished in Pylkkänen (2008) as 'high applicatives' and 'low applicatives' are found in SA.⁶³ The point of interest for us is that geminate causatives contrast with root clauses and the other causative constructions in SA in not permitting applied arguments (to be shown below). We make sense of this state of affairs by proposing that in geminates, Causee⁰ and Appl⁰ are bundled (Pylkkänen 2008; Harley 2017a). As such, the same argument bears two θ -roles, whereas in other instances CauseeP and ApplP remain as separate projections, which permits different arguments to bear θ -roles associated with each projection.⁶⁴

Before proceeding with the discussion, we establish that similar to the DP causee versus PP causee contrast discussed earlier, a DP beneficiary is an argument, whereas a PP beneficiary is an adjunct. Recall that in SA only arguments can be clefted, and adjuncts are not licit cleft pivots. A DP beneficiary can be clefted, (416), whereas a PP beneficiary cannot be, (417).

- (416) a. kemal ku i-qri leyla lala kitab.
Kemal PROG.3M 3M-read.IPFV Leyla this.M book
'Kemal is reading Leyla this book.'

⁶³Note that the position of Pylkkänen's (2008) low applicatives as structurally below VP has been challenged by many researchers, and have been suggested to occupy the same position as high applicatives, i.e. between VoiceP and *v*P (Anagnostopoulou 2003; Bruening 2010; Larson 2010; Georgala 2011; Legate 2014). I also assume both to occupy the same position.

⁶⁴This is different from the question of whether a language allows the so-called applicative recursion, i.e. the possibility of more than one applied argument. It has been observed that in most languages with both high and low applicatives, only one applied argument is permitted in any given clause (Marantz 1993; McGinnis 1998; Nie 2020), and very few languages allow applicatives to combine (e.g. Kinyarwanda, Ngoboka 2005). SA also disallows applicative recursion, thus (i).

- (i) *kemal ada mara oranciyad zakk-in lala kitab.
Kemal gave.3M woman students intelligent-PL this.M book
'Kemal gave intelligent students this book for the woman.'

Although applicative recursion in itself is a significant phenomenon (see Nie 2020 for discussion), the discussion here is about the contrast between matrix and embedded structures.

- b. Leyla ye (ande) le Kemal ku i-qri _ lala kitab.
 Leyla COP.3SG who that Kemal PROG.3M 3M-read.IPFV this.M book
 ‘It is Leyla that Kemal is reading this book.’

- (417) a. kemal ku i-qri lala kitab mışa leyla.
 Kemal PROG.3M 3M-read.IPFV this.M book for Leyla
 ‘Kemal is reading this book for Leyla.’

- b. *mışa Leyla ye (ande) le Kemal ku i-qri lala kitab.
 for Leyla COP.3SG who that Kemal PROG.3M 3M-read.IPFV this.M book
 ‘It is for Leyla that Kemal is reading this book.’

Secondly, a DP beneficiary can be raised to become the grammatical subject in line with its argumenthood status, as shown in (418b).

- (418) a. kemal ku i-qri leyla lala kitab.
 Kemal PROG.3M 3M-read.IPFV Leyla this.M book
 ‘Kemal is reading Leyla this book.’

- b. Leyla ki t-in-qari lala kitab (mı Kemal).
 Leyla PROG.3F 3F-PASS-read.IPFV this.M book (by Kemal)
 ‘Leyla is being read this book (by Kemal).’

Against this backdrop, let us start with investigation of ‘make’-causatives, which will serve as another comparative basis with geminates and the GiveC. Examples in (419a), (420a) and (421a) demonstrate that applicative arguments can co-occur with the causee in unergatives, transitives and ditransitives respectively (For the sake of completeness, I also provide the PP adjunct beneficiary in b. examples).

- (419) a. kemal sa faqz-la sari killu.
 Kemal made.3M run.INF-her morning all
 ‘Kemal made someone run for her the whole morning.’

- b. kemal sa faqz mışa-na.
 Kemal made.3M run.INF for-her
 ‘Kemal made someone run for her.’

- (420) a. kemal sa tabx-la / ?leyla kek.
 Kemal made.3M bake.INF-her / ?Leyla cake
 ‘Kemal made someone bake her / Leyla a cake.’

b. kemal sa tabx kek mışa-*na* / mışa leyla.
 Kemal made.3M bake.INF cake for-her / for Leyla
 ‘Kemal made someone bake a cake for her / Leyla.’

(421) a. kemal sa tarx-*la* / leyla hadiya-ma.
 Kemal made.3M send.INF-her / Leyla gift-a
 ‘Kemal made someone send her / Leyla a gift.’

b. kemal sa tarx hadiya-ma mışa-*na* / mışa leyla.
 Kemal made.3M send.INF gift-a for-her / for Leyla
 ‘Kemal made someone send a gift to her/Leyla.’

Finally, (422) indicates that the same possibility is available when ‘make’ embeds a passive VoiceP, as indicated by the presence of a ‘by’-phrase.

(422) a. kemal sa tabx-*la* kek mı aşçi-ma gıze muhim.
 Kemal made.3M bake.INF-her cake by cook-a so important
 ‘Kemal had a cake baked for her by a very important cook.’

b. kemal sa tabx kek mışa-*na* mı aşçi-ma gıze muhim.
 Kemal made.3M bake.INF cake for-her by cook-a so important
 ‘Kemal had a cake baked for her by a very important cook.’

On the other hand, geminates exhibit a contrast between the possibility of a DP versus PP beneficiary. Starting with unergatives, (423b) shows that DP applicatives are disallowed, whereas they are allowed as adjunct PPs, (423c).

(423) a. faqqız-tu kemal.
 ran.CAUS-1SG Kemal
 ‘I made Kemal run.’

b. *faqqız-to-*lla* kemal.
 ran.CAUS-1SG-her Kemal
 ‘I made Kemal run for her.’

c. faqqız-tu kemal mışa-*na*.
 ran.CAUS-1SG Kemal for-her
 ‘I made Kemal run for her.’

The same co-occurrence restriction also holds with transitive predicates in both the active

and passive CauseeP, as shown in (424) and (425) respectively.⁶⁵ (424c) indicates that the order of the causee and the applicative is not the issue.⁶⁶

- (424) a. *oratman ku i-qarri kemal kitab-ma mışa-na / mışa leyla.*
 teacher PROG.3M 3M-read.CAUS Kemal book-a for-her / for Leyla
 ‘The teacher is making Kemal read a book for her/Leyla.’
- b. **oratman ku i-qarri-lla / leyla kemal kitab-ma.*
 teacher PROG.3M 3M-read.CAUS-her / leyla Kemal book-a
 ‘The teacher is making Kemal read her / Leyla a book.’
- c. **oratman ku i-qarri kemal leyla kitab-ma.*
 teacher PROG.3M 3M-read.CAUS Kemal Leyla book-a
 Intended: ‘The teacher is making Kemal read Leyla a book.’
- (425) a. *oratman ku i-qarri kitab-ma mışa kemal.*
 teacher PROG.3M 3M-read.CAUS book-a to Kemal
 ‘The teacher is having a book read by Kemal.’
- b. *oratman ku i-qarri kitab-ma mışa kemal mışa leyla.*
 teacher PROG.3M 3M-read.CAUS book-a to Kemal for Leyla
 ‘The teacher is having a book read by Kemal for Leyla.’
- c. #*oratman ku i-qarri-lla kitab-ma mışa kemal.*
 teacher PROG.3M 3M-read.CAUS-her book-a to Kemal
 YES: ‘The teacher is making her read a book for Kemal.’
 NO: ‘The teacher is having a book read her by Kemal.’

Another example with the transitive verb ‘to pour’ in the active embedded structure

⁶⁵Note that a potential confound is available in this construction as to which structure the beneficiary is associated with. This sentence allows the following two interpretations: (i) ‘The teacher, for the benefit of Leyla, forced [Kemal to read the book]’, in which case the matrix subject ‘the teacher’ is associated with bringing out the beneficiary reading for Leyla; or (ii) ‘The teacher forced [Kemal to read the book for the benefit of Leyla]’ in which scenario, the teacher is not involved as to who benefits from the caused event, but the causee *Kemal* performs the action for the benefit of *Leyla*. It is also possible to construct scenarios which unambiguously allow the latter reading. This can be achieved by making the matrix subject inanimate, as such it would lack sentience. Consider (i).

- (i) *şımsak tı-qarri kemal kitab-ma mışa leyla.*
 thunderstorm 3F-read.CAUS Kemal book-a for Leyla
 ‘The thunderstorm is making Kemal read a book for Leyla (instead of them going out and playing).’

⁶⁶Gemination does not apply to ditransitive bases in Arabic (e.g. *give, send, donate, tell*, see Hallman 2006), including in SA. Whether this restriction follows from a deep explanation must await future work. It is however worth noting that it is consistent with the idea of Causee and Appl head bundling in geminates.

follows:

- (426) a. Hasan ku i-dabbex kemal mayn mişa-na / mişa leyla.
Hasan PROG.3M 3M-pour.CAUS Kemal water for-her / for Leyla
'Hasan is making Kemal pour water for her/Leyla.'
- b. *Hasan ku i-dabbex-lla / leyla kemal mayn.
Hasan PROG.3M 3M-pour.CAUS-her / leyla Kemal water
'Hasan is making Kemal pour her / Leyla water.'
- c. *Hasan ku i-dabbex kemal leyla mayn.
Hasan PROG.3M 3M-pour.CAUS Kemal Leyla water
Intended: 'Hasan is making Kemal pour Leyla water.'

It is worth emphasizing that the patterns in (423) through (426) are about *benefactives* in geminate causatives. The patterns demonstrate that a benefactive DP argument is ruled out, whereas a benefactive PP adjunct is allowed in geminates, regardless of whether the embedded predicate is unergative or transitive.⁶⁷ This DP versus PP contrast indicates that there is not an interpretative restriction in having applied elements in the geminates, but it is more of a syntactic restriction. Applied elements are compatible in geminates as long as they are introduced as PP adjuncts, but not as DP arguments. This is in line with the crosslinguistic picture. As discussed in Chapter 1, in Turkish the benefactive can be introduced as a DP or a PP. This is illustrated for the stative verb like “hold” in you can express it with both options, (427). However, an unaccusative like “die” allows the benefactive to be expressed only as a PP, (428).

- (427) a. Çocuk yaşlı adam-a şemsiye-yi tut-tu.
child old man-DAT umbrella-ACC hold-PST
'The child held the umbrella for the old man.'
- b. Çocuk yaşlı adam için şemsiye-yi tut-tu.
child old man for umbrella-ACC hold-PST
'The child held the umbrella for the old man.'

⁶⁷This pattern, however, is distinct from the the *causee* patterns introduced earlier, e.g. (359-360) versus (175). The causee behaves differently from the benefactive, in that the realization of the causee is sensitive to the predicate type. While it can be realized as a DP argument or as a PP adjunct with transitives, (175), it can only be realized as a DP argument with unergatives, as in (359) and (360). It is significant to not conflate these two patterns. I leave the discussion of the causee pattern to the end of this section.

- (428) a. *Asker vatan-ın-a öl-dü.
 soldier country-3POSS-DAT die-PST
 ‘The soldier died for his/her country.’
- b. Asker vatan-ı için öl-dü.
 soldier country-3POSS for die-PST
 ‘The soldier died for his/her country.’

In this respect, geminates in SA differ from root clauses and ‘make’-causatives, which allow applicatives both in the form of a DP argument and a PP adjunct. Let us now examine the GiveC, which only has a passive structure. They disallow unergatives (presumably because unergatives cannot form personal passives in SA). Examples in (429) and (430) demonstrate that with transitive predicates, the causee can co-occur with an applied argument. The b. examples are instances of benefactives introduced as PP adjuncts, whereas c. examples illustrate benefactives as DP arguments.

- (429) a. dade ād-e addil dolabad mışa tamirci.
 mother gave-3F fix.INF shelves to repairman
 ‘Mom had the shelves fixed by the repairman.’
- b. dade ād-e addil dolabad mışa tamirci mışa bint-a / mışa-na.
 mother gave-3F fix.INF shelves to repairman for daughter-her / for-her
 ‘Mom had the shelves fixed by the repairman for her daughter / for her.’
- c. dade ād-e addil-la / addil leyla dolabad mışa tamirci.
 mother gave-3F fix.INF-her / fix.INF Leyla shelves to repairman
 ‘Mom had the shelves fixed by the repairman for her / Leyla.’
- (430) a. dade ād-e qaru kitab mışa kemal.
 mother gave-3F read.INF book to Kemal
 ‘Mom had the book read by Kemal.’
- b. dade ād-e qaru kitab mışa kemal mışa bint-a / mışa-na.
 mother gave-3F read.INF book to Kemal for daughter-her / for-her
 ‘Mom had the book read by Kemal for her daughter / for her.’
- c. dade ād-e qaru-lla / qaru leyla kitab mışa kemal.
 mother gave-3F read.INF-her / read.INF Leyla book to Kemal
 ‘Mom had the book read by Kemal for her / Leyla.’

‘Give’-causatives of ditransitive predicates also exhibit the same behavior in allowing a causee and an applicative argument to co-occur. Consider (431).⁶⁸

- (431) a. *dade ād-e tarx leyla kitab mışa kemal.*
 mother gave-3F send.INF Leyla book to Kemal
 ‘Mom had Leyla sent the book by Kemal.’
 (i.e. Mom made Kemal send Leyla the book).
- b. *dade ād-e tarx-la kitab mışa kemal.*
 mother gave-3F send.INF-her book to Kemal
 ‘Mom had her sent the book by Kemal.’ (i.e. Mom made Kemal send her the book).

The findings in this section can be summarized in Table 3.4.⁶⁹ Various diagnostics indicate that geminates and the GiveC differ from ‘make’-causatives and root clauses in terms of agentive properties. This motivated an analysis of CauseeP as opposed to VoiceP. However, geminates and the GiveC also differ from each other in terms of allowing an applied argument. Whereas the GiveC permits the co-occurrence (thus patterning like ‘make’-causatives in this respect), geminates do not.⁷⁰

I capture this point of difference between the causative constructions by proposing that in geminates, Causee⁰ and Appl⁰ bundle (following Pylkkänen 2008; Harley 2017a). As such, a single argument bears both Causee and benefactive θ -roles, and this indeed is re-

⁶⁸The ungrammaticality of (i) indicates that the pattern in SA is different from Austronesian applicativized arguments which cannot remain in-situ, and thus either are realized as a PP or A-move to become the grammatical subject (e.g. Pearson 2001; Richards 2001; Rackowski and Richards 2005; Legate 2014).

- (i) **kemal m-ada qaru kitab.*
 Kemal PASS-gave.3M read.INF book
 ‘Kemal was made to read the book.’

The possibility of unergatives with ‘make’-causatives as well as the difference from the Austronesian languages suggest that it is not a Case problem.

⁶⁹Note that the generalization cannot be that GiveC ApplPs don’t have the PP restriction which geminate ApplPs do. This is because the geminate examples from (423) through (426), and GiveC examples from (429) through (431) show that a PP adjunct benefactive is licit in either causativization strategy regardless of the predicate type. Therefore, we are not dealing with a sort of PP restriction.

⁷⁰In Pylkkänen’s (2008) causative typology based complement selection, if a causee cannot be modified by agent-oriented modifiers, the complement cannot contain a high applicative (and vice versa). This type of causative was argued to contain *vP* as opposed to VoiceP. Table 3.5 demonstrates that this cannot be true, since the causee in the GiveC lacks agentive properties, but the embedded structure does allow a high applicative.

	Root clause	‘make’-causatives	Geminates	GiveC
Active-Passive?	✓	✓	✓	Passive
Agentive properties?	✓	✓	*	*
Applied argument?	✓	✓	*	✓

Table 3.5: Properties of causative types

flected in the interpretation of these causatives. The causee is also interpreted as the beneficiary/maleficiary of the caused event.⁷¹ The bundling structure is schematized in (432).

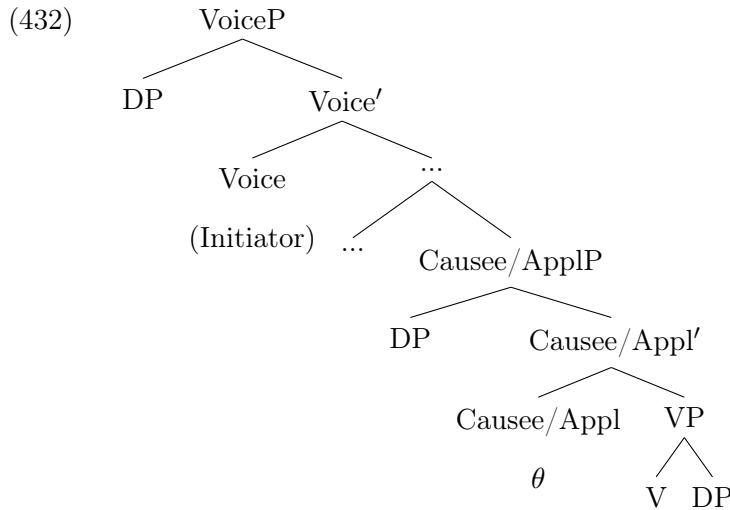

On the other hand, with ‘make’-causatives and the GiveC, the projections introducing the embedded agent and the causee respectively are not bundled with the Appl that they dominate. (433) represents the structure of ‘make’-causatives in which both the embedded agent and the applicative argument are generated in VoiceP and ApplP respectively.

⁷¹This analysis is reminiscent of Guasti’s (1996) analysis of the Italian *fare infinitive (FI)* construction, in which the agent of the embedded verb is also suggested to receive a benefactive theta role from the causative verb. See also Ippolito 2000 (similar to Zubizarreta 1985) for the argument that the causee in FIs is introduced by Appl and is comparable to benefactives. See also Nash (2017) for a similar point about Georgian causatives.

I use the label CauseeP to differentiate it from CausP used by e.g., Key (2013); Harley (2017a) in which CausP roughly corresponds to (and is explicitly likened to) ApplP.

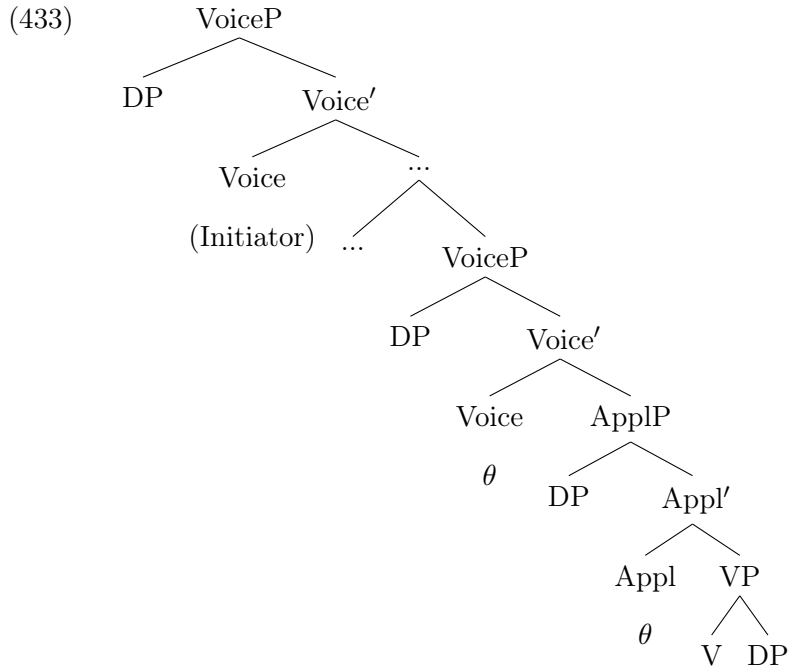

A similar non-bundling structure is observed in the GiveC, as illustrated in (434), where the causee, whose θ -role is saturated by the DP inside the PP, and the applicative are introduced in different projections.

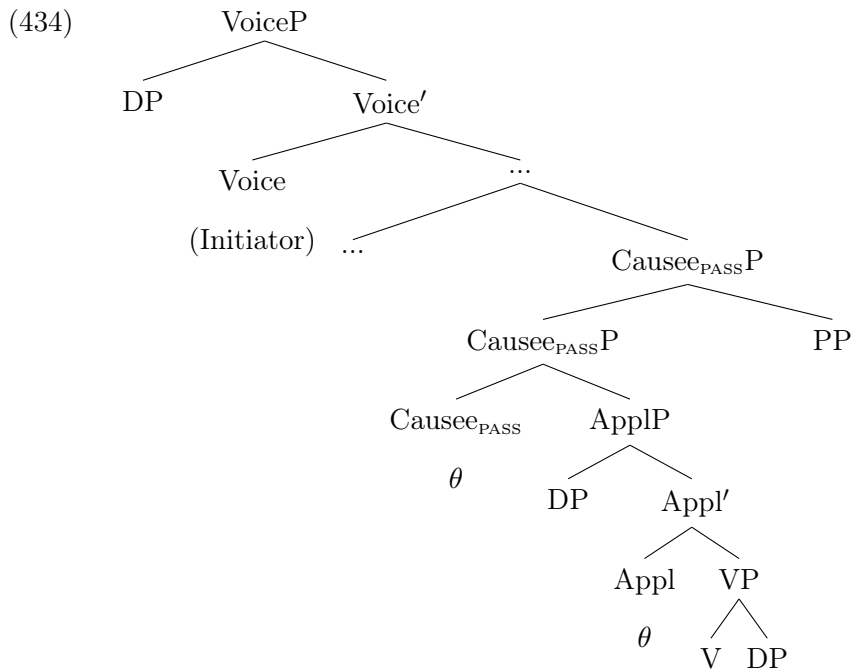

Note that when the matrix verb is passivized in (434), the applied argument raises to become the grammatical subject. This is illustrated in (435).

- (435) leyla m-ād-e tarx kitab miša kemal (mī dade).
 Leyla PASS-gave-3F send.INF book to Kemal (by mother)
 ‘Leyla was made (by mother) to be sent the book by Kemal.’

This section has demonstrated that in geminates, Causee⁰ and Appl⁰ bundle (Pylkkänen 2008; Harley 2017a), as such a single argument carries Causee and benefactive θ -roles. On the other hand, with the GiveC and ‘make’-causatives, no bundling takes place, and as a result, different arguments bear distinct θ -roles.

Finally, I briefly touch upon the contrast between the *causee* of unergative and transitive bases of geminates. As mentioned early on in the chapter, the causee of a transitive can be introduced as a DP or PP, whereas the causee of an unergative may only be a DP, (436).

- (436) kemal ku i-faqqez (*miša) kelb.
 Kemal PROG.3M 3M-run.CAUS to dog
 ‘Kemal is making the dog run.’ (Yakut, 2013, 34b)

Given that with transitive bases, a DP versus PP causee reflects an active versus passive alternation with the DP being an argument and PP an adjunct, it follows that unergative bases would allow the causee to be expressed only as a DP since they cannot form personal passives in SA. I take this to be a low-level, language-particular syntactic fact, as languages may differ in this regard (see also Legate et al. 2020); other languages, such as Germanic languages, could have different properties. Recall that in Chapter 1, we have seen that in Turkish, passive is limited in application to transitive predicates with a thematic subject and structurally case marked object (for many speakers), whereas unergative or unaccusative predicates are not passivizable. Sason Arabic appears to mark this distinction in the case of arguments in CauseeP. Therefore, the causee of embedded unergative predicate fails to meet the requirements for passivization, and as such cannot be expressed as a PP, whereas the causee of a transitive predicate can be realized either way. In the analysis of the passive developed in this dissertation (and also Legate et al. 2020), such restrictions can be encoded in the selectional properties of the passive Voice/Causee/Apppl head.

3.4 Chapter summary

In this chapter I have investigated several causativization strategies in SA, particularly ‘make’-causatives, gemination and GiveC, mainly with a focus on the embedded structures and the status of the null causee in these structures.

The discussion of ‘make’-causatives has revealed that ‘make’-causatives embed a reduced structure: no AspP or higher projections (i.e. a restructuring configuration). It embeds a passive VoiceP, or an FP dominating an active VoiceP. The embedded agent can be introduced in two ways in the active VoiceP: (i) as a ‘free variable’ on the Voice head. This adds to the typology of implicit arguments. It also shows that the theme can be (Case-) licensed as an object independently of the thematic subject. (ii) as a full DP, which is subject a locality restrictions. The embedded agent needs to \bar{A} -move to be in local configuration with its licensor. As such, ‘make’-causatives are part of a larger crosslinguistic pattern, in which certain positions cannot be occupied with overt elements.

The discussion of gemination and the GiveC has provided further support to the analysis of passive in Legate 2014 as well as Chapter 1, for which passive is a variant of a functional head that introduces a DP in its specifier, a configuration that is available to not just VoiceP, but also to other functional categories. This predicts that an active-passive-like alternation should be available in other functional heads as well. I have demonstrated that these two causative strategies do embed a second VoiceP, however this VoiceP exhibits distinct behavior from the canonical, agentive VoiceP, which warrants identifying it as a distinct category. As such, the causee in both constructions is generated in CauseeP. Furthermore, a variety of diagnostics show that geminates manifest an active-passive alternation, whereas the GiveC embeds only a passive CauseeP. Therefore, the null argument in these constructions is an implicit ‘agent’ of passives.

I have further investigated the (in)compatibility of the causee with an applicative argument, and demonstrated that causatives show variation in this respect. Whereas geminates disallow the occurrence of an applied argument, this is permitted in ‘make’ and ‘give’-

causatives as well as root clauses. I have captured this asymmetry by proposing that in geminates, Causee⁰ and Appl⁰ are bundled together, and as such the same argument ends up bearing two θ -roles. On the other hand, these heads are separate in the ‘give’-causatives (in the sense of Pylkkänen 2008; Harley 2017a).

Chapter 4

Causatives in Turkish

This chapter of the dissertation investigates the properties of the causatives in Turkish from several different angles, which connect to the main thread of the dissertation.

In the first part of the chapter, I analyze the syntax of Turkish causatives, with a focus on determining the structural properties of the embedded constituent and the status of the overt causee versus null causee. Key (2013) and Harley (2017a) have argued that Turkish causatives are verb-selecting (in the sense of Pykkänen 2008) as such they embed a vP layer, but not a VoiceP layer. Nie (2020, 137) proposes a structure that is essentially identical to that of Key (2013) and Harley (2017a) in terms of the relevant features. She suggests that Turkish causatives do embed a VoiceP, but this VoiceP is non-active, found in anticausatives/unaccusatives, i.e. does not introduce an argument in its specifier. Furthermore, all three studies have argued that the overt (dative) causee in Turkish causatives is an adjunct, and not an argument (Key 2013; Harley 2017a; Nie 2020).

I argue that neither of the arguments regarding Turkish causatives is tenable. With regard to the first point, I demonstrate that Turkish causatives do indeed embed a VoiceP (contra Key 2013; Harley 2017a), which is crucially also active (contra Nie 2020). I label this VoiceP as $\text{Voice}_{\text{CAUSEE}}\text{P}$. Moreover, I show that the characterization of the causee as an adjunct is also not tenable. Instead, the Causee is indeed an argument, base-generated in $\text{Spec,Voice}_{\text{CAUSEE}}\text{P}$. One of the arguments to that end involves investigation of some non-standard varieties of Turkish, which differ from the standard variety in the type of argument allowed to raise to the grammatical subject. On the other hand, the null causee is not syntactically projected, but is existentially interpreted in passive $\text{Voice}_{\text{CAUSEE}}$.

The second part of the chapter addresses the other implications that derive from the analysis in the first part of the chapter. It focuses on the question of which predicates or configurations allow the causee to be left unpronounced, and thus interpreted existentially. I first provide a thorough picture of the patterns, which complements the partial pattern in Stromdahl and Nematova (2019a,b). Then I propose an explanation that does not rely on the adjunct status or the case of the Causee. I argue that the availability of the existential reading is connected to a domain-specific transitivity, in that what counts as transitive in root clauses versus causatives is different.

4.1 A first look at causatives in Turkish

This section provides a brief introduction of the causative constructions in Turkish, particularly causativization of transitive and intransitive bases (a more thorough look at the pattern will be undertaken in section 4.5). Turkish has the following causative allomorphs: *-Dir*, *-t*, *-Ir*, *-Ar*, *-It*, *-Art* (Göksel and Kerslake, 2005).¹

In standard Turkish, when transitive constructions like (437a) are causativized, the causee, *bütün misafirler* ‘all guests’, is marked for dative case, as seen in (437b).² Moreover, it is the theme of the embedded verb that is promoted to become the grammatical subject of the clause when passivized, (437c). The derived subject receives nominative case and agrees with the verb of the main clause. The causee is not an intervener for the raising of the embedded theme. On the other hand, raising of the causee leads to ungrammaticality, (437d). This last point indicates that the statement Tonyalı (2015, 2) makes, i.e. “causees

¹I do not discuss the (Root-conditioned) causative allomorphs. See e.g. Göksel and Kerslake 2005; Nakipoğlu and Üntak 2008; Key 2013, 2020.

²I should note that although not discussed in the literature, it is possible to find examples in which the causee is expressed as a comitative PP, as shown in (i). I also leave their discussion aside.

- (i) Sallanan sandalye-miz-i en son hamal-lar-la buraya taşı-t-tı-m.
 shaking chair-our-ACC most final porter-PL-with here carry-CAUS-PST-1SG
 ‘I had our shaking chair be carried here by the porters.’

Accessed on March 11, 2020 from <https://www.mymemur.com.tr/pembe-evin-manasini-anladim-141yy.htm>. The causee ‘children’ in the attested example changed to ‘porters’ as a more salient alternative.

which receive *structural* dative case in Turkish causative constructions are not examined in this study (emphasis mine)” is not correct (at least for the standard variety of Turkish as will be discussed later).

- (437) a. bütün misafir-ler araba-yı temizle-di-ler.
 all guest-PL car-ACC clean-PST-3PL
 ‘All the guests cleaned the car.’
- b. bütün *misafir-ler-i / misafir-ler-e araba-yı temizle-t-ti.
 all *guest-PL-ACC / guest-PL-DAT car-ACC clean-CAUS-PST
 ‘(S/he) made all the guests clean the car.’
- c. araba bütün misafir-ler-e temizle-t-il-di.
 car all guest-PL-DAT clean-CAUS-PASS-PST
 ‘The car was made (by him/her) to be cleaned by all the guests.’
- d. *bütün misafir-ler araba-yı temizle-t-il-di.
 all guest-PL car-ACC clean-CAUS-PASS-PST
 ‘All the guests were made to clean the car.’

On the other hand, when an intransitive verb is causativized, the sole argument carries accusative case. This is illustrated for the unergative verb ‘to run’ in (438).

- (438) a. Sporcu koş-tu.
 athlete run-PST
 ‘The athlete ran.’
- b. Antrenör sporcu-yu / *sporcu-ya koş-tur-du.
 trainer athlete-ACC / *athlete-DAT run-CAUS-PST
 ‘The trainer made the athlete run.’

(439a) is an illustration of a non-causative sentence with an unaccusative verb. Its morphological causative counterpart is shown in (439b), realized through the affixation of a single morpheme to the predicate and an added nominal to the clause. (439c) is the passive counterpart of (439b), in which the accusative case-marked internal argument becomes the grammatical subject.³

³At least some unergatives (as confirmed by their ability to appear in episodic sentences with the null impersonal) appear to behave in this manner as well. Consider (i).

- (439) a. Kalem masa-dan düş-tü.
pencil table-ABL fall-PST
'The pencil fell from the table.'
- b. Leyla kalem-i masa-dan düş-ür-dü.
Leyla pencil-ACC table-ABL fall-CAUS-PST
'Leyla dropped the pencil from the table.'
NOT: 'Leyla caused someone to drop the pencil from the table.'
- c. Kalem masa-dan (Leyla tarafından) düş-ür-ül-dü.
pencil table-ABL Leyla by fall-CAUS-PASS-PST
'The pencil was dropped from the table (by Leyla).'

As shown in (440), the whole is a simple transitive verb phrase, consisting of a VoiceP, the causative vP, and the phrase headed by the root. (440a) is the structure for the active clause in (439b), and (440b) is the configuration for the passive (439c).

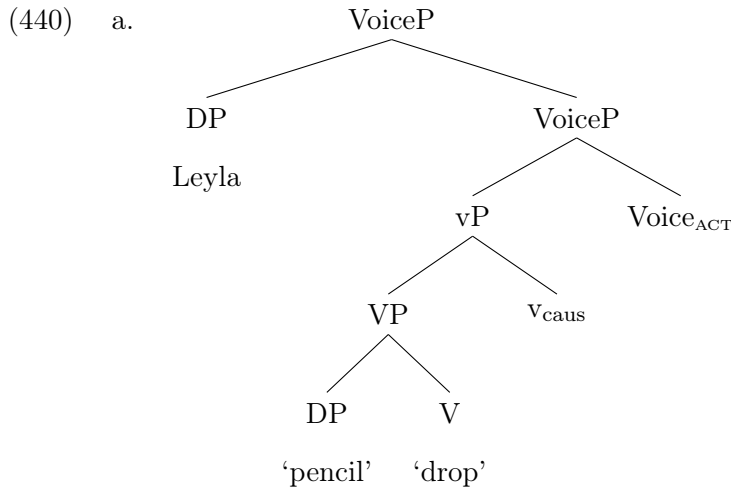

-
- (i) a. Bebek uyu-du.
baby sleep-PST
'The baby slept.'
- b. Bakıcı bebeğ-i / *bebeğ-e uyu-t-tu.
baby.sitter baby-ACC / *baby-DAT sleep-CAUS-PST
'The baby-sitter slept the baby / put the baby to sleep.'

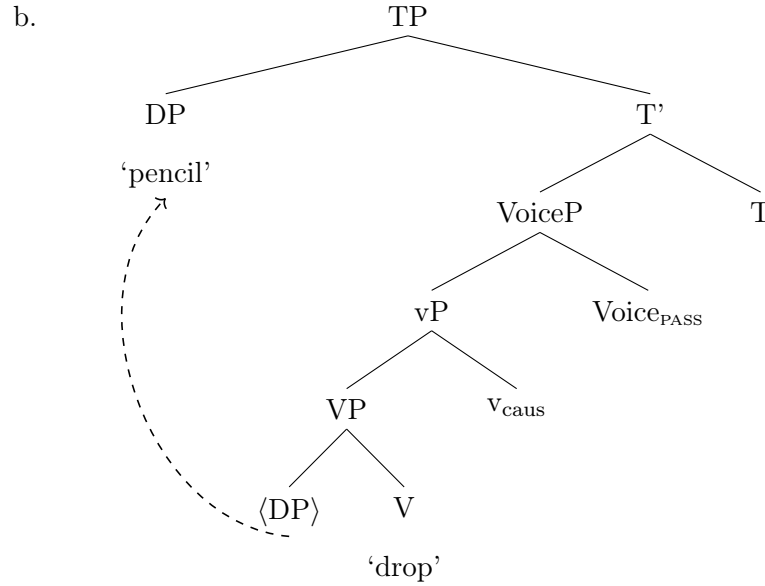

In the next section, I examine the structural properties of the embedded constituent in Turkish causatives, specifically whether the embedded constituent is VoiceP or smaller. A question commonly raised regarding Turkish causatives is whether they are mono-clausal or bi-clausal (e.g. Çetinoğlu et al. 2008). Instead of approaching them from this binary perspective, I investigate their properties in light of the diagnostics implemented for Sason Arabic in Chapter 3 as well as some Turkish specific tests.

4.2 Size of the embedded structure

The structure, particularly the size of the embedded constituent, in causatives has figured prominently in Turkish causatives. This section applies a variety of diagnostics, revisiting some of the diagnostics from the literature, and concludes that Turkish indirect causatives are not verb-selecting, but embed a Voice_{CAUSEE}P.

4.2.1 An overview of some previous literature

As one of the earliest works on Turkish causatives, Zimmer (1976) treats the causative with an overt [dative] causee, (441), like a ditransitive, in which “the original subject becomes a *surface indirect object* ...” (p., 400).

(441) adam-a kapı-yı aç-tır-dı-k.
 man-DAT door-ACC open-CAUS-PST-1PL
 ‘We made the man open the door.’ (Zimmer 1976:4)

On the other hand, he states the following for causatives with null causee, as in (442):
 “the passive analysis would have to be constrained so that only agentless passives ... could be embedded under CAUSE...” (Zimmer 1976:407).⁴

(442) Hasan kutu-yu aç-tır-dı.
 Hasan box-ACC open-CAUS-PST
 ‘Hasan had the box opened.’ (Zimmer 1976:32)

More recently, Key (2013) and Harley (2017a) compare causatives in Japanese and Turkish, and reach the following conclusions regarding (i) the size of the embedded structure, (443), and (ii) the status of the Causee, (444).

(443) *The size of the embedded structure* (following Pytkänen’s (2008) classification):

- Japanese productive causatives are **phase-selecting** (i.e., dominated by a *Voice* projection), which results in two layers.
- whereas Turkish causatives are **verb selecting** (more precisely *vP*). They lack an embedded *VoiceP* that would introduce a Causee.

(444) *The status of the Causee*:

- The Japanese causee is an **argument** (in *Spec, VoiceP*),
- whereas the overt dative causee in Turkish is an **adjunct** (to *Caus’/CausP*) (a la Schäfer 2012).

I leave the discussion about the status of the Causee to the next section, and focus on Key’s (2013) and Harley’s (2017a) arguments about the size of the embedded structure for Turkish causatives. Their structures are primarily motivated on the basis of comparison

⁴Cf. Aissen 1974, for a transformational analysis of passivization.

with Japanese causatives. Key 2013 characterizes Japanese productive causatives as ‘phase-selecting’, in that each causative is dominated by a Voice projection, which results in two layers. This is illustrated in (445).

(445) Japanese productive causatives

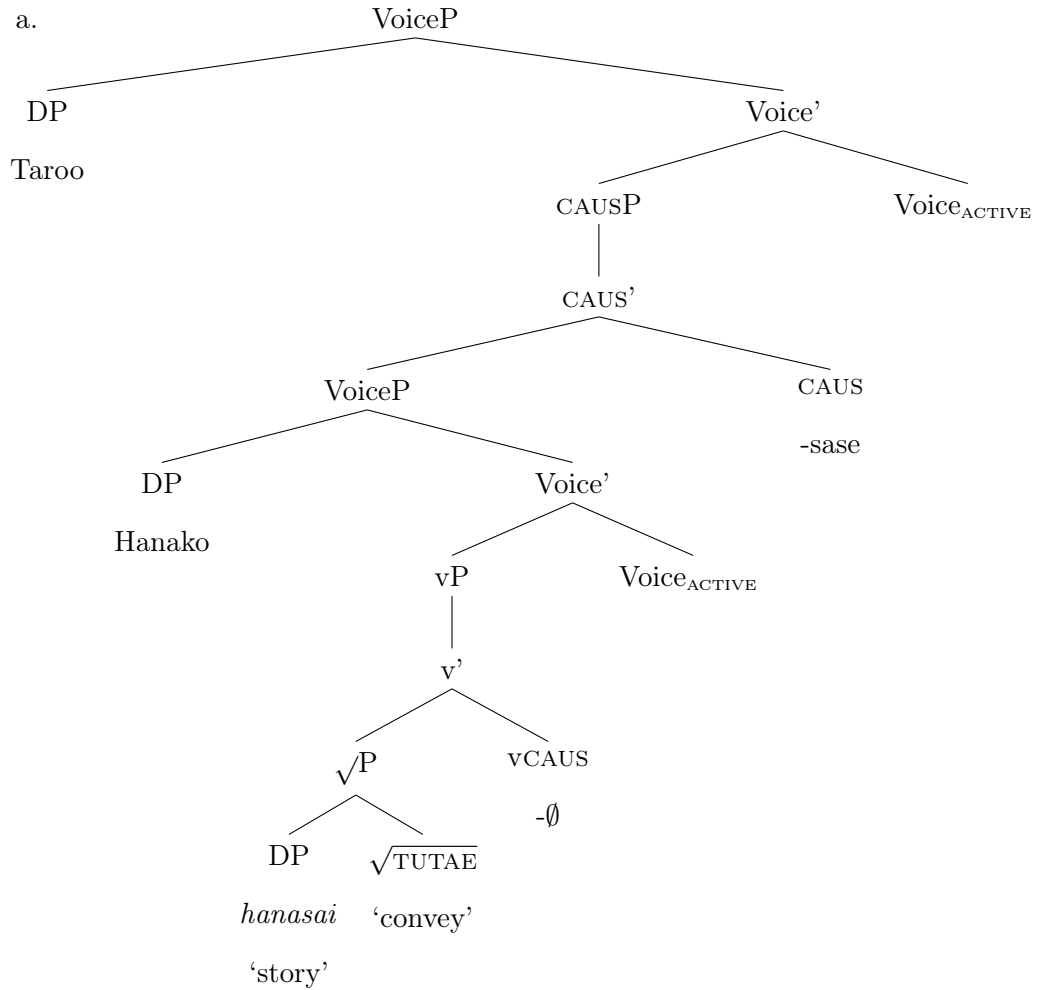

- b. Taroo-wa Hanako-ni hanasi-o tutae-sase-ta.
 Taroo-TOP Hanako-DAT story-ACC convey-CAUS-PST
 ‘Taroo made Hanako convey a story.’ (Key 2013: 183)

On the other hand, Key (2013) proposes that the Turkish outer causative is verb selecting. They lack an embedded VoiceP that would introduce a Causee. Instead, Turkish productive causatives are headed by a dedicated CausP projection embedding a vP. Accordingly, Key (2013) suggests the structure in (446a) for a causative construction with an overt

Causee, i.e. (446b).⁵

(446) a.

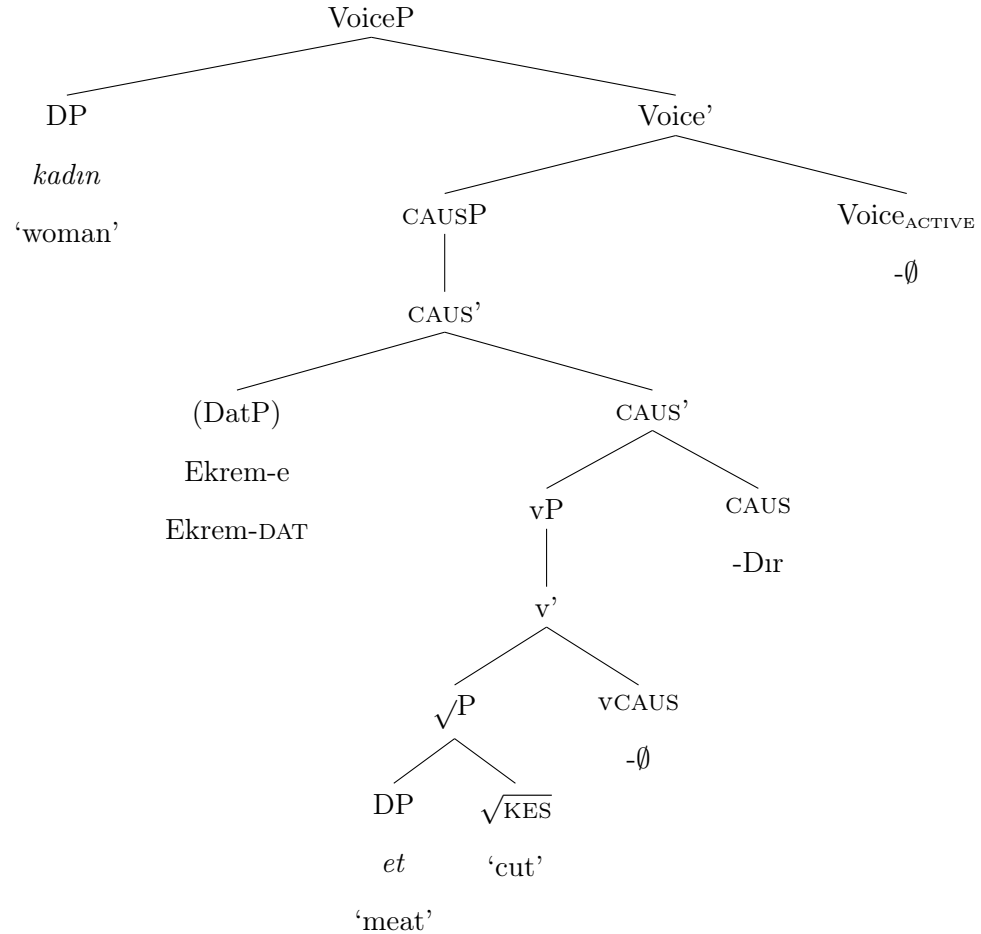

b. Kadın Ekrem-e et-i kes-∅-tir-di.
 woman Ekrem-DAT meat-ACC cut-∅-CAUS-CAUS-PST

'The woman had the meat cut/had Ekrem cut the meat.' (Key 2013: 185)

Besides the absence of VoiceP, another important property of (446a) is that the Causee is introduced as an adjunct to Caus',⁶ rather than as an argument in Spec,CausP (to be discussed in the next section).

⁵It should be noted that Key's proposal is couched within the DM framework and reflects certain assumptions/claims, which I will gloss over since they are not the main focus here. For instance, one of Key's main goals is to account for the allomorphy in the Turkish verb. While Turkish lexical causatives exhibit root-conditioned allomorphy, while productive causatives never do. To capture this dichotomy, Key (2013) argues that the outer (productive) causatives realize a different type of syntactic head than inner (Root) causatives do. The inner causative is the CAUS flavor of the verbalizer little-v, while the productive/high-attaching causative is a CAUS head that lacks any verbalizing properties.

⁶In Harley (2017a, 21), the adjuncthood of the causee is represented as adjunction to maximal projection CausP, rather than the bar level (though this makes no difference).

On the other hand, the counterpart of the sentence in which the causee is null, (447b), would have the structure in (447a).

(447) a.

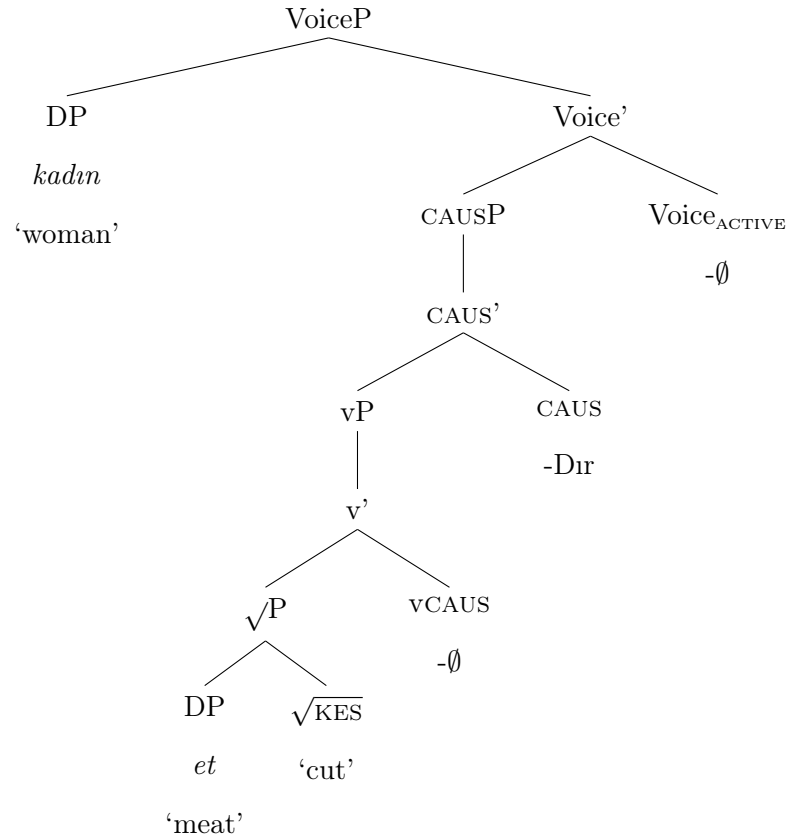

b. Kadın et-i kes-∅-tir-di.
 woman meat-ACC cut-v.CAUS-CAUS-PST

'The woman had the meat cut/had (someone) cut the meat.' (Key 2013: 184, original glossing maintained)

The structures for Japanese and Turkish productive causatives are partly motivated by the contrast between the so-called lexical causatives and syntactic causatives in Japanese. On the basis of various diagnostics, Harley (2008, 2017a) concludes that only productive causatives pattern biclausally in Japanese. For instance, only with the productive causatives can an adverbial phrase, *-te* in (448), modify the matrix causer or the embedded agent (Shibatani 1972).⁷

⁷Also see Miyagawa 1998, 1999. Other diagnostics for the biclausality of productive causatives include *binding*: binding condition B is satisfied when an embedded object is coindexed with the matrix Causer, so

- (448) a. Hanako-wa arui-te it-ta
 Hanako-TOP walk-*te* go-PST
 ‘Hanako, walking, went.’
- b. Taroo-wa arui-te Hanako-o ik-ase-ta.
 Taroo-TOP walk-*te* Hanako-ACC go-*sase*-PST
 ‘Taro made Hanako go, walking.’
- OR ‘Taro, walking, made Hanako go.’ (Harley 2008: 30)

This contrasts with lexical causatives which behave as if there is a single predicate.

- (449) a. Hanako-wa nure-te hi-e-ta
 Hanako-TOP wet-*te* cool-*inch*-PST
 ‘Hanako (’s body), getting wet, cooled.’
- b. Taroo-wa nure-te Hanako-o hi-(y)as-ita.
 Taroo-TOP wet-*te* Hanako-ACC cool-*caus*-PST
 YES: ‘Taroo, getting wet, cooled Hanako.’
 NO: ‘Taroo cooled Hanako, (Hanako) getting wet.’ (Harley 2008: 30)

It is claimed that adverbials in Turkish pattern like Japanese lexical causatives, in that they only pick out the matrix causer, and not the embedded agent. This in turn leads to the treatment of Turkish as a verb-selecting language. We will see however that this conclusion is too hasty since various diagnostics (including agent-oriented adverbs) can indeed be associated with the embedded agent in Turkish.⁸

To preview my analysis, I disagree with both of the conclusions about the size of the embedded structure and the status of the Causee. With respect to the former, I argue that Turkish causatives embed a VoiceP (or Voice_{causee}P), i.e. a larger structure than vP. Moreover, the overt Causee in Turkish is an argument introduced in Spec,VoiceP, and not

the embedded and matrix clauses count as independent binding domains, and *coordination*: the embedded clause can conjoin with another clause, within the scope of the matrix causative.

⁸Note that even if agent-oriented adverbs could not pick out the embedded agent, it would not necessarily mean that Turkish causatives behave like Japanese lexical causatives, which are essentially mono-eventive. In fact, it is possible that Japanese lexical causatives are like Turkish causatives built on unaccusative bases, (cf. 440), which yield a simple transitive verb phrase overall. This would straightforwardly explain the restriction observed in Japanese examples in (449). Manner adverbs and ‘again’ adverbial modification (see §4.2.2) demonstrate that Turkish causatives are bi-eventive, and contain two *v* layers.

an adjunct. Ultimately, my overall proposal is similar to Zimmer (1976) (with some modifications about the status of the dative Causee).

Before proceeding with the discussion, I first establish that the standard diagnostics used in the literature to pick out a thematic Voice layer apply to Turkish root clauses by comparing their behavior in unaccusatives versus passives. After establishing that they hold in Turkish clauses, I carefully apply them to Turkish causatives since some of them have been employed in the literature (Çetinoğlu et al. 2008; Key 2013; Harley 2017a).

Agent-oriented adverbs (e.g., *gönüllüce* ‘willingly’, *isteksizce* ‘reluctantly’) are not compatible with the former, but are with the latter.

(450) a. unaccusative

Kapı (*isteksizce) çök-tü.
door (reluctantly) collapse-PST
‘The door collapsed (*reluctantly).’

b. passive

Kapı (isteksizce) onar-ıl-dı.
door (reluctantly) renovate-PASS-PST
‘The door was renovated (reluctantly).’

Another example follows in (451).

(451) a. Düşman (*kalleşçe) öl-dü.
enemy (viciously) die-PST

‘The enemy died (*viciously).’

b. Düşman (kalleşçe) öldür-ül-dü.
enemy (viciously) kill-PASS-PST

‘The enemy was killed (viciously).’ (from *Ramo*, a TV show, Episode 10)

Instrumentals yield a similar contrast. The instrument reading for ‘with hammers’ is not available in the anticausative, (452a), whereas it is available in the passive, (452b).

(452) a. unaccusative

Kapı (*çekiç-le) çök-tü.
door (hammer-with) collapse-PST

YES: ‘The door collapsed along with the hammer.’

NOT: ‘The door collapsed using the hammer.’

b. passive

Kapı (çekiç-le) onar-ıl-dı.
door (hammer-with) renovate-PASS-PST

‘The door was renovated with the hammer (i.e., using the hammer).’

As demonstrated in (453), agent-oriented comitatives pattern with instrument phrases and agent-oriented adverbs in picking out a Voice layer.

(453) a. unaccusative

Kapı (*Kemal-le) çök-tü.
door (Kemal-with) collapse-PST

‘The door collapsed with (the help of) Kemal.’

b. passive

Kapı (Kemal-le) onar-ıl-dı.
door (Kemal-with) renovate-PASS-PST

‘The door was renovated with (the help of) Kemal.’

Expectedly, ‘by’-phrases are ungrammatical in the unaccusative/inchoative, whereas are possible in the passives.

(454) a. unaccusative

Kapı (*işçi-ler tarafından) çök-tü.
door (worker-PL by) collapse-PST

‘The door collapsed (*by the workers).’

b. passive

Kapı (işçi-ler tarafından) onar-ıl-dı.
door (worker-PL by) renovate-PASS-PST

‘The door was renovated (by the workers).’

On the reverse side, unaccusatives are compatible with the Turkish counterpart of *by itself*, whereas passives are not.

(455) a. unaccusative

Kapı (kendi kendi-ne) çök-tü.
door (self self-DAT) collapse-PST
'The door collapsed (by itself).'

b. passive

Kapı (*kendi kendi-ne) onar-ıl-dı.
door (*self self-DAT) renovate-PASS-PST
'The door was renovated (*by itself).'

These diagnostics indicate that agent-oriented commitatives, agent-oriented adverbs, instrumentals and 'by'-phrases tend to occur in the same environments (Bruening, 2013; Legate, 2014; Alexiadou et al., 2015). Given that they pick out a canonical Voice layer in Turkish root clauses, we can apply these diagnostics to causatives in Turkish.

4.2.2 The structure of the embedded constituent

First, we can establish that the causatives are bi-eventive (i.e. two *v* layers) given that it is possible to use two distinct manner adverbs (some of which are taken from Ernst 2001, 2020):

(456) Patron {sinirli / yorgun / sakin / düşünceli bir şekil-de } işçi-ler-e
boss {angry / tired / calm / thoughtful a manner-LOC } employee-PL-DAT
buzdolabı-m {yavaşça / ağır ağır } taşı-t-tı.
fridge-ACC {slowly / slow slow } carry-CAUS-PST
'The boss, {angrily / tired / calmly / thoughtfully}, made [the workers carry the
fridge {slowly / in a sluggish manner}].'

(457) Yaşlı kadın, ağır ağır (bir şekilde), hevesli gençler-e kilim-i ustalıkla
old woman slow slow (a manner) enthusiastic youth-DAT rug-ACC skillfully
doku-t-tu.
weave-CAUS-PST
'The old woman, (though) slowly, made the enthusiastic young people weave the rug
skillfully.'

(458) Dolandırıcı {çabucak / inanılmaz sakin bir şekilde } tüm belge-ler-i
conman {quickly / incredibly calm a manner } all document-PL-ACC

mağdur-lar-a {acayip hızla / özensizce } imzala-t-ma-yı başar-dı.
victim-PL-DAT {pretty fast / carelessly } sign-CAUS-NMLZ-ACC manage-PST
‘The conman {quickly / incredibly calmly} managed to make the victims sign all the
documents {rapidly / carelessly} (and then he left the scene right away).’

It is also possible to target the presence of a higher *v* by using the adverbial modification, e.g. *tekrardan* ‘again’ for (459). I take a standard view of *again* as a type <s,t> modifier (von Stechow 1996; Beck and Johnson 2004), accordingly at least the following four attachment sites in (460) are potentially possible, which corresponds to the four interpretations in (461).

(459) Geçim sıkıntısı (tekrardan) yaşlı adam-a tefeci-den (tekrardan) borç
financial difficulty (again) old man-DAT loanshark-ABL (again) debt
al-dır(t)-dı.
borrow-CAUS-PST
‘The financial difficulties again made the old man borrow money from loan-sharks.’

(460) *again*₁ [_{VOICEP} *again*₂ [_{V-CAUS} *again*₃ [_{VOICE-CAUSEEP} *again*₄ [_{VP} borrow money]]]]

- (461) a. **Reading 1 (*again* above matrix VoiceP):** The financial difficulties made the old man borrow money from the loan-sharks, the same financial difficulties had made the old man borrow money from loansharks before.
- b. **Reading 2 (*again* above *v-caus*, below matrix VoiceP):** The financial difficulties made the old man borrow money from the loan-sharks, previously it was the threats of the mafia that made him do so.
- c. **Reading 3 (*again* above embedded Voice, below matrix *v*):** The old man had borrowed money before for no reason at all, just for the fun/heck of it. The same old man borrowed money from the loansharks again, this time, financial difficulties made him do so.
- d. **Reading 4 (*again* above the embedded *v*, below the embedded Voice):**
[most saliently available when *again* is placed between *loanshark* and *debt*.]
Money had been borrowed from the loanshark before (maybe by some young man, for the heck/fun of it or due to his gambling issues), and this time by an old man due to his financial issues.

Readings 2 and 3 crucially differentiate a causing event from a projection that embeds the Causee. This further supports the presence of a higher little *v* projection. Note that the presence of a causing event and a caused event (thus two separate *v* layers) appears to be assumed without argumentation,⁹ but these tests allow us to motivate this assumption.

Turning to higher positions in the clause, the embedded constituent lacks a TP layer since distinct temporal adverbs are disallowed.

- (462) *Patron dün işçi-ler-e buzdolabı-m bugün taşı-t-tı.
 boss yesterday employee-PL-DAT fridge-ACC today carry-CAUS-PST
 ‘The boss, yesterday, made [the workers carry the fridge today].’

There is no aspect layer, as shown in (463).

- (463) *Patron işçi-ler-e buzdolabı-m taşı-**yor**-t-tu.
 boss employee-PL-DAT fridge-ACC carry-PROG-CAUS-PST
 ‘The boss made the workers be carrying the fridge.’

Negation is also disallowed below the causative morpheme.¹⁰

- (464) *Patron işçi-ler-e buzdolabı-m taşı-**ma**-t-tı.
 boss employee-PL-DAT fridge-ACC carry-NEG-CAUS-PST
 ‘The boss made the workers not carry the fridge.’

Let us now turn to the standard diagnostics implemented to detect the thematic Voice layer. It turns out that an almost uniform picture emerges once we consider all the diagnostics, helped by salient contexts.

Starting with the most evident diagnostic, (465) shows that the passive morphology is not allowed to the left of the causative suffix, where it is expected to occur if the causative embeds a passive Voice.

- (465) *Kadın et-i (kasap tarafından) kes-il-dir-di.
 woman meat-ACC butcher by cut-PASS-CAUS-PST
 ‘The woman had the meat be cut by the butcher.’ (Aissen and Hankamer 1980:239)¹¹

⁹The causing event layer, i.e., higher *v*, is designated as CAUS in Key (2013); Harley (2017a).

¹⁰Nie (2020) uses negation to as a test for eventhood rather than NegP, using the interpretation of a single negation morpheme. The reasoning is not clear to me, since Neg can negate anything in its scope and so that could yield the reading (*I didn’t eat apples, but oranges*).

¹¹I added the paranthesis to the original example. Key (2013) reports that following a liquid, *-t* and not

‘By’-phrases used to introduce the external arguments are also disallowed, even without a passive morpheme.

- (466) *Kadın et-i kasap tarafından kes-tir-di.
 woman meat-ACC butcher by cut-CAUS-PST
 ‘The woman had the meat be cut by the butcher.’

Agent-oriented adverbs are used as another diagnostic to target the presence or absence of a thematic Voice layer (Pylikkänen 2008; Legate 2014, a.o.). Such adverbs have been used for Turkish causatives and seem to constitute the primary evidence for the absence of an embedded agent. (467) and (468) are usually cited to argue that such adverbs pick out only the causing agent, and not the embedded agent. Thus, ‘reluctantly’ is reported to pick out ‘mother’ in (467), and not the embedded agent ‘child’ in Turkish. Similarly, in (468), only the matrix Causer is reported to control a subject-oriented adverbial.¹²

- (467) anne çocuğ-a kitab-ı isteksizce oku-t-tu.
 mother child-DAT book-ACC reluctantly read-CAUS-PST
 ‘The mother reluctantly made [the child read the book].’

NOT: ‘The mother made [the child read the book reluctantly].’ (Çetinoğlu et al., 2008, 8)

- (468) Tarkan_i Hakan-a_j Mehmet-i bil-erek_{i/*j} döv-dür-dü.
 Tarkan Hakan-DAT Mehmet-ACC on.purpose beat-CAUS-PST
 YES: ‘Tarkan, on purpose, made Hakan beat Mehmet.’

NO: ‘Tarkan made [Hakan beat Mehmet on purpose].’ (Harley, 2017a, 29)

Indeed at first glance, it is pretty hard to get a reading in which the above adverbs pick out the embedded agent. However, it turns out that once we control for saliency and other pragmatic effects, agent-oriented adverbs can indeed be associated with the embedded

-Dir is the allomorph used (thus *kes-il-t-ti*). Regardless of this change, the sentence is still ungrammatical.

¹²Nie (2020, 136-137) also assumes these data about agent-oriented adverbs, and argues that Turkish causatives encode two events but only introduce a single agent. The causing event takes as its complement a VoiceP headed by a non-active Voice[-D]. And Causees may merge as adjuncts to the lower VoiceP. This is in contrast to Japanese, which are also biclausal, but also embed a second active Voice[+D], in whose specifier the Causee is introduced (Nie 2020:135-136). The discussion here indicates that Turkish should be categorized as Japanese.

agent. More importantly, in some contexts, the embedded agent is the only available target for such adverbs.

Providing a more appropriate context for a Causee reading improves things a lot, as shown in (469).¹³

(469) Context: Filling the hearts of her students with the love of poetry the whole semester, at the end-of-the-year ceremony, the teacher ...

(?)Orhan Veli şiir-in-i öğrenciler-e öyle bir heves-le / şevk-le
 Orhan Veli poem-CM-ACC students-DAT such a enthusiasm-with / eager-with
 oku-ttur-du ki, öğrenciler-in heves-ler-i / şevk-ler-i
 read-CAUS-PST so.that students-GEN enthusiasm-PL-POSS / eager-PL-POSS
 izleyenler-i çok mutlu et-ti.
 audience-ACC much happy do-PST

‘The teacher made the students read the Orhan Veli poem so enthusiastically/eagerly that the students’ enthusiasm/eager made the audience very happy.’¹⁴

It is even possible to construct examples in which the embedded agent is the only licit DP that can be associated with the agent-oriented adverb. (470) through (472) involve inanimate matrix causers, which cannot be targeted by the agent-oriented adverb. Therefore, the adverbs are necessarily associated the agent of the caused event in each scenario.¹⁵

(470) Orman yangınları, köy-ler-in-i çok sev-en ama başka seçenek-ler-i
 forest fires village-PL-POSS-ACC much love-REL but other choice-PL-POSS
 kal-ma-yan köy halkı-na ev-ler-in-i {isteksizce / zoraki /
 remain-NEG-REL village folk-DAT house-PL-POSS-ACC {reluctantly / forcedly /
 istemeyerek } boşalt-tır-dı.
 unwillingly } evacuate-CAUS-PST

‘The wildfires made the villagers, who love their villages, but were left with no choice,

¹³The judgements come from my consultants, which were further confirmed by around 10-12 Turkish speaking audience at TU+6 (6th Workshop on Turkic and Languages in Contact with Turkic), who provided judgments during my presentation over the Zoom chat function.

¹⁴Most speakers at TU+6 found (469) fully grammatical, while a couple of speakers noted *biraz tuhaf* ‘slightly odd’ into the Chat.

It is worth also pointing that some speakers reported that even the examples cited in the literature, i.e., (467) and (468), improve a lot with different adverbs.

¹⁵This is crucial since as far as I can tell, most of the work on other languages use sentences very similar to (467) and (468) when discussing agent-oriented adverbs. We have seen that providing a salient context, potentially controlling for prosodic factors might change the empirical picture. Using an inanimate matrix causer, in languages that allow it, is another configuration that can be used.

evacuate their homes {reluctantly / forcedly / unwillingly}.’

- (471) (?)anne-sin-in hastalığ-ı iste-me-se de, yıldız oyuncu-ya son
mother-POSS-GEN illness-POSS want-NEG-COND even star player-DAT last
maç-ta gönülsüzce şike yap-tırt-tı.
game-LOC reluctantly rig do-CAUS-PST
‘The illness of his mother made the star player, no matter how much he didn’t want
to, rig the final game reluctantly.’

- (472) Sonunda kazan-acağ-ı büyük para-nın hayal-i Kemal-e iş-i
finally win-NMLZ-POSS large money-GEN dream-POSS Kemal-DAT job-ACC
{seve seve / şevkle } yap-tırt-tı.
{enthusiastically / eagerly } do-CAUS-PST
‘The dream of the money he was gonna make at the end of the job made Kemal
finish the job enthusiastically/eagerly.’

Instrument phrases and agent-oriented comitatives are the other two diagnostics, which to my knowledge have not been in the Turkish literature (and have not been incorporated in the studies on other languages). I demonstrate that they also can be associated with the embedded agent.

An illustration of instrument phrases picking out the the embedded agent in Turkish is provided in (473).

- (473) Buralar-ı çamaşır suyu ile temizle-t-ti-m.
here-ACC bleach with clean-CAUS-PST-1SG
‘I had all these places cleaned with bleach.’¹⁶

Other examples of instrumentals are provided in (474) and (475).

- (474) (?)Saç-ım-ı berber-e makas-la kes-tir-di-m, (yani makas
hair-my-ACC hairdresser-DAT scissors-COMM cut-CAUS-PST-1SG (that.is scissors
kullan-dır-arak).
use-CAUS-ARAK)
‘I made [the hairdresser cut my hair with the scissors], (i.e. by using scissors).’¹⁷

¹⁶<https://www.birgun.net/haber/hastanede-maskesiz-ve-eldivensiz-koronavirus-testi-yapan-personel-e-sorusturma-316091>, Retrieved November 20, 2020.

¹⁷Speakers prefer *makas zoruyla* ‘with the force of scissors’ for a causer interpretation. It is also possible to have two instrument phrases one associated with the causing event and another the caused event. In such instances, however, it is preferable to express one of the instruments in a different form or morphology.

- (475) El-in-i yüz-ün-ü köy-ün kaynak su-yu-yla
 hand-POSS-ACC face-POSS-ACC village-GEN spring water-CM-with
 yıka-t-tı-m.
 wash-CAUS-PST-1SG
 ‘I had her wash her hands and face with the village’s spring water.’¹⁸

Similarly, *agent-oriented comitatives* allow a causee-targeting interpretation.

- (476) Context: in order to demonstrate the importance of cooperation, the teacher ...

her bir öğrenci-ye zor geometri soru-su-nu sıra arkadaşı-yla
 every one student-DAT hard geometry question-CM-ACC desk friend-with
 göz-dür-dü.
 solve-CAUS-PST

‘The teacher made each student solve the hard geometry question with his/her desk-mate (i.e., with the help of his/her deskmate).’

Another piece of evidence comes from the verbal morphology depending on one’s approach. Key (2021) has recently argued that the overt causative morpheme in Turkish causative-alternating transitive verbs, as in (477), occupies the active Voice head, and various verbalizers they are built on occupy the little *v*. This is illustrated in (478).

(477)	<u>adjective/noun root</u>	<u>intransitive verb</u>	<u>transitive verb</u>	
	<i>hafif</i> ‘light’	<i>hafif-le</i>	<i>hafif-le-t</i> ‘lighten’	
	<i>az</i> ‘little’	<i>az-al</i>	<i>az-al-t</i> ‘decrease’	
	<i>nem</i> ‘humidity’	<i>nem-len</i>	<i>nem-len-dir</i> ‘humidify’	
	<i>katı</i> ‘solid’	<i>katı-laş</i>	<i>katı-laş-tır</i> ‘solidify’	(Key 2021:7-8)

¹⁸<https://zeez.infones.gretmenn/>, Accessed on August 10, 2020.

4.3 The status of the overt (dative) causee

Another conclusion that Key (2013) and Harley (2017a) reach about Turkish causatives concerns the status of the overt (dative) causee in Japanese versus Turkish. As mentioned in the previous section, they propose that the Japanese causee is an **argument** (in Spec,VoiceP), whereas the overt dative causee in Turkish is an **adjunct** (to Caus'/CausP) (à la Schäfer 2012). The causee being an adjunct (to CausP) in Turkish, but an argument (in Spec,VoiceP) in Japanese is motivated by two differences in these languages.²⁰

The first difference relates to the *optionality of the Causee*: in Turkish, the Causee may be omitted, while in Japanese it may not (Harley, 2017a, 20):

(480) a. Japanese

*Taroo-wa hanasi-o tutae-sase-ta.

Taroo-TOP story-ACC convey-CAUS-PST

'Taroo had a story conveyed/Taroo made (someone) convey a story.' (based on Key 2013: 183)

b. Turkish

Hasan hikaye-yi anlat-tır-dı.

Hasan story-ACC convey-CAUS-PST

'Hasan had the story conveyed/Hasan made (someone) convey a story.'

This difference is taken to mean that Turkish causee is an optional adjunct, whereas the Japanese causee is an argument, thus obligatory.

The second argument comes from *passivization differences*. In Japanese the Causee is promoted in a passive and the embedded object cannot be (Harley, 2017a, 20). On the other hand, in standard Turkish, the Causee is immune to passivization. It behaves as inert (in the sense of McGinnis 2001) in the presence of an accusative embedded object, (481b). Thus, the embedded theme bearing accusative case is promoted to the nominative grammatical subject, the dative neither itself moving, nor blocking movement past it, as shown in (481).

²⁰Nie (2020, 137) also has the same conclusion, where the Causee is an adjunct to non-active VoiceP.

- (481) a. bütün misafir-ler-e araba-yı temizle-t-ti.
 all guest-PL-DAT car-ACC clean-CAUS-PST
 ‘(S/he) made all the guests clean the car.’
- b. araba bütün misafir-ler-e temizle-t-il-di.
 car all guest-PL-DAT clean-CAUS-PASS-PST
 ‘The car was made (by him/her) to be cleaned by all the guests.’
- c. *bütün misafir-ler araba-yı temizle-t-il-di.
 all guest-PL car-ACC clean-CAUS-PASS-PST
 ‘All the guests were made to clean the car.’

In the case of a non-accusative case bearing embedded object, there is no raising to grammatical subject position (Öztürk 2005; Legate et al. 2020, i.a.).

- (482) bütün misafir-ler-e araba temizle-t-il-di.
 all guest-PL-DAT car clean-CAUS-PASS-PST
 ‘One made all the guests clean car(s) (do car-cleaning).’

I argue that the differences between Japanese in terms of the optionality of the Causee and the passivization asymmetries do not warrant treating the Causee in Turkish as an adjunct. I provide four arguments to show that the overt causee is an argument in Turkish, and not an adjunct. These are clefting, passivization in non-standard Turkish, long-distance scrambling and island constraints.

4.3.1 Clefting

The first argument comes from clefting. Gribanova (2013) reports that cleft constructions in Uzbek allow argument pivots, but not adjunct pivots (see also Stromdahl and Nematova 2019b for the same argument in Uzbek, Soltan 2019 for Egyptian Arabic, and Chapter 3 for Sason Arabic). In Uzbek, the pivot is a nominative NP that agrees with a copula (visible in the past tense), and the cleft is a headless relative clause. Consider (483).

- (483) Uzbek
- [Bola-m maqta-gan] men-(*i) e-di-m.
 child-POSS.1SG praise-PTCP I-ACC be-PST-1SG

‘It was me that my son praised.’ (Stromdahl and Nematova 2019b: 41)

As expected, the external arguments in the passive cannot be clefted given their adjuncthood status.

(484) Uzbek

*[Ona-m maqta-l-gan] men (tomonim(dan)) e-di-(m).
mother-1SG praise-PASS-PTCP I by be-PST-1SG

Intended: ‘It was by me that my mother was praised.’ (Stromdahl and Nematova 2019b: 42)

Turkish shows the same behavior as Uzbek in terms of their structure and restriction as to what can be a cleft pivot. Cleft constructions target arguments, (485), not adjuncts, (486).

(485) Turkish

a. [Çocuğ-um-un iki gün önce öv-düğ-ü] ben i-di-m.
child-POSS.1SG-GEN two day ago praise-PTCP-POSS I be-PST-1SG
‘It was me that my son praised _ yesterday.’

b. [Çocuğ-u öv-en] ben i-di-m.
child-ACC praise-PTCP I be-PST-1SG
‘It was me that _ praised the child.’

c. [Kitab-ı gönder-diğ-i] ben i-di-m.
book-ACC send-PTCP-POSS I be-PST-1SG
‘It was me that s/he sent _ the book.’

(486) Turkish

a. *[Çocuğ-um-un ben-i öv-düğ-ü] (zaman) iki gün önce i-di.
child-POSS.1SG-GEN I-ACC praise-PTCP-POSS time two day ago be-PST
‘It was two days ago that my son praised me.’

b. *[Anne-m-in öv-ül-düğ-ü] ben-im tarafımdan i-di.
mother-POSS.1SG-GEN praise-PASS-PTCP-POSS I-GEN by be-PST
‘It was by me that my mother was praised.’

It turns out the causee of causativized predicates can be clefted, regardless of whether it is marked with dative, (487), or accusative case, (488). This demonstrates that the causee patterns like an argument, and not an adjunct.

(487) Turkish

- a. Ban-a kitab-ı oku-t-tu.
I-DAT book-ACC read-CAUS-PST
'S/he made me read the book.'
- b. [Kitab-ı oku-t-tuğ-u] ben i-di-m.
book-ACC read-CAUS-PTCP-POSS I be-PST-1SG
'It was me that s/he made read the book.'

(488) Turkish

- a. Ben-i koş-tur-du-lar.
I-ACC run-CAUS-PST-3PL
'They made me run.'
- b. [Koş-tur-duk-lar-ı] ben i-di-m.
run-CAUS-PTCP-PL-3.POSS I be-PST-1SG
'It was me that they made run.'

4.3.2 Passivization in non-standard Turkish

The second argument concerns the passivization diagnostic. Key (2013) and Harley (2017a) take the fact that the causee cannot be targeted by passivization, as in (481), to mean that it must be an adjunct to CausP. However, I believe this property of causees does not warrant that Causees be adjuncts. The explanation lies elsewhere, i.e. in the *Case* of the causee: as mentioned in Chapter 1, for speakers of standard Turkish, the dative behaves as nonstructural, as in (489b), and the causee is just another instance of this pattern. However, in non-standard varieties of Turkish, the dative behaves as structural rather than inert. In these varieties, passivization of verbs with a dative object is grammatical, the dative object of the active raising to the nominative grammatical subject of the passive, as shown in (489c) (I mark these sentences, including the attested ones, with % to show that they are grammatical for some group of speakers).

- (489) a. Komşu-lar adam-lar-a yardım et-ti-ler.
neighbour-PL man-PL-DAT help do-PST-PL
'The neighbours helped the men.'

- b. * Adam-lar-a komşu-lar tarafından yardım ed-il-di-(ler).
 man-PL-DAT neighbour-PL by help do-PASS-PST-PL
 ‘The men were helped by the neighbours.’
- c. % Adam-lar komşu-lar tarafından yardım ed-il-di-ler.
 man-PL neighbour-PL by help do-PASS-PST-PL
 ‘The men were helped (by the neighbours).’

Another attested example, also confirmed by the speakers of this variety, follows in (490). In (490c), the verbal agreement on the verb ‘to torture’ indicates that the internal argument has raised to grammatical subject position.²¹

- (490) a. Hayvan-lar-a işkence et-ti-ler.
 animal-PL-DAT torture do-PST-3PL
 ‘They tortured animals.’
- b. Hayvan-lar-a işkence ed-il-di.
 animal-PL-DAT torture do-PASS-PST
 ‘There was torturing to animals.’
- c. %Döv-ül-dü-ler, işkence ed-il-di-ler, aç susuz bırak-ıl-dı-lar...
 beat-PASS-PST-PL torture do-PASS-PST-PL hungry waterless leave-PASS-PST-PL
 ‘They were beaten, tortured, left hungry and thirsty...’²²

Although non-standard varieties are rarely discussed in the literature, it is possible to find references to them. For instance, Knecht 1986 reports that for some speakers a clause containing an oblique transitive verb may also undergo canonical (‘personal’, in her terms) passivization; as such becomes the grammatical subject, as shown in (491).

- (491) a. Ben san-a/*sen-i tap-tı-m.
 I you-DAT/*you-ACC worship-PST-1SG
 ‘I worshipped you.’
- b. San-a tap-ıl-dı.
 you-DAT worship-PASS-PST
 ‘There was worshipping to you.’

²¹In this and following examples, I sometimes construct the baseline sentences on the basis of attested ones.

²²http://www.haytap.org/index.php?option=com_content&view=article&id=2344:hayvanlara-iskence-suc-kabul-edilmeli&catid=56:yazili-basin. Accessed on January 19, 2019.

- c. % Sen tap-ıl-dı-n.
 you.NOM worship-PASS-PST-2SG
 ‘You were worshipped.’ (Knecht 1986:111)

The examples so far involved dative case bearing arguments, but this phenomenon is not limited to verbs assigning dative. (492) and (493) illustrate two verbs that assign instrumental case in Turkish.

(492) *-yle alay et-* ‘to mock’

- a. ben-le / *ben-i alay et-ti-ler.
 I-INST / *I-ACC mock do-PST-PL
 ‘They mocked me.’
- b. % farklı düşün-en-ler ... alay ed-il-iyor-lar.
 different think-REL-PL mock do-PASS-PROG-PL
 ‘Those who think differently are mocked.’
 (Twitter; @ikarus_deadalus, 8/3/20)

(493) *-yle dalga geç-* ‘to make fun of’

- %Hep dalga geç-il-di-ler, hiç ciddi-ye al-ın-ma-dı-lar.
 always make.fun.of-PASS-PST-PL never serious-DAT take-PASS-NEG-PST-PL
 ‘They were always made fun of, never taken seriously.’²³

Similarly, illustrations of two arguments bearing ablative case are in (494) and (495).

(494) *-den nefret et* ‘to hate’

- %Büyük kitleler tarafından sev-il-di-ler daha büyük-ler-i tarafından
 big masses by like-PASS-PST-PL more big-PL-POSS by
 nefret ed-il-di-ler.
 hate do-PASS-PST-PL

‘They were liked by large masses, but hated by even bigger masses.’²⁴

(495) *-den vazgeç-* ‘to replace, give up’

- Kendini vazgeçilmez zannetme, (don’t consider yourself irreplaceable)

²³<https://www.sozcu.com.tr/2016/yazarlar/ozlem-gurses/tek-umudumuz-laikci-teyzeler-1423565/>

²⁴<https://medium.com/radyoytu/punka-ne-oldu-2e38ffc53f1c>

%bir gün sen de vazgeç-il-ecek-sin.
one day you also replace-PASS-FUT-2SG

‘One day you will also be replaced.’(Facebook; Behçet Alkan, Sept 30, 2020)

Therefore, for speakers of non-standard Turkish, dative (and other cases) can behave as structural. Crucially for our purposes, for the same group of speakers, raising of the dative causee to the grammatical subject is also possible. This is illustrated in (496). The plural agreement on the verb in (496c) shows that the causee indeed has raised to nominative even though nominative is null in the language. Interestingly, these varieties are subject to a restriction, in that it is not possible to raise the causee in the presence of an accusative marked object, (496d) (I touch upon this restriction later).

- (496) a. Onlar bok ye-di-ler.
they.NOM shit eat-PST-3PL
‘They ate shit.’
- b. Asker-ler onlar-a bok ye-dir-di-ler.
soldier-PL they-DAT shit eat-CAUS-PST-3PL
‘The soldiers made them eat shit.’
- c. %Köy-ler-i yak-ıl-dı... Zor-la sürgün ed-il-di-ler... **Bok**
village-PL-3POSS burn-PASS-PST force-with exile do-PASS-PST-3PL shit
ye-dir-il-di-ler... İşkence-den geç-ir-il-di-ler...
eat-CAUS-PASS-PST-3PL torture-ABL pass-CAUS-PASS-PST-3PL
‘Their villages were burned... They were exiled by force... They were made to eat shit... They were put to the torture...’²⁵
- d. *... bok-u ye-dir-il-di-ler...
shit-ACC eat-CAUS-PASS-PST-3PL
‘They were made to eat the shit.’

Another example follows in (497). In (497c), the causee *hepimiz-e* ‘all.of.us-DAT’ raises to become the grammatical subject, and triggers 1pl agreement on the verb . Similarly, the embedded object needs to be incorporated, and a case-marked theme leads to ungrammaticality, (497d).

²⁵https://www.sabah.com.tr/yazarlar/akoz/2009/10/25/baris;steyenler_kizgin_turklere_anlayis_gostermeli. Accessed on December 21, 2018.

- (497) a. Okul-da yabancı dil oku-du-k.
 school-LOC foreign language study-PST-1PL
 ‘We studied foreign language(s) at school.’
- b. Çünkü hepimiz-e okul-da yabancı dil oku-t-tu-lar.
 because all.of.us-DAT school-LOC foreign language study-CAUS-PST-3PL
 ‘It is because they made all of us study foreign language(s) at school.’²⁶
- c. %Bugün eğitim-de nitelik değil nicelik politikası
 today education-LOC quality not quantity policy-CM
 izle-n-diğ-i için zaten ver-il-en eğitim vasat,
 follow-PASS-NMLZ-ACC for already give-PASS-REL education mediocre
hep-imiz senelerce yabancı dil **oku-t-ul-du-k.**
 all.of.us for.years foreign language study-CAUS-PASS-PST-1PL
 ‘As today in education, quantity, not quality policy is followed, the education
 that is provided is mediocre, all of us were made study foreign language(s) at
 school for years.’²⁷
- d. *... hep-imiz senelerce yabancı dil-i oku-t-ul-duk.
 all-1PL.NOM for.years foreign language-ACC study-CAUS-PASS-PST-1PL
 ‘All of us were made study the foreign language at school for years.’

Below are some more examples that exhibit the same pattern.

- (498) %Çocuk-lar araba temizle-t-il-di-ler.
 child-PL car clean-CAUS-PASS-PST-3PL
 ‘The children were made to clean car(s).’
- (499) %Sebep-siz yer-e sürekli temizlik yap-tır-ıl-dı-lar.
 reason-less place-DAT always cleaning do-CAUS-PASS-PST-3PL
 ‘For no reason, they were made to do cleaning all the time.’
- (500) a. Biz-e 10 dakika müzik dinle-t-ti-ler.
 we-DAT ten minute music listen-CAUS-PST-3PL
 ‘They made us listen to music for ten minutes.’

²⁶http://www.turkiyatjournal.com/Makaleler/1704787284_Dilek%20ERENOĞLU.pdf. Accessed on January 19, 2019.

I changed the causee in the original example of (497b) from ‘us’ to ‘all of us’ to form a minimal pair with the example in (497c).

²⁷<https://forum.donanimhaber.com/finlandiya-da-egitimde-devrim-tum-dersler-kaldirildi--135939095-3>. Accessed on January 19, 2019.

- b. %Müşteri hizmetleri-ni ara-dı-m ve *pro* her zamanki gibi 10 dakika
customer services-ACC call-PST-1SG and every time like ten minute
müzik **dinle-t-il-di-k**.
music listen-CAUS-PASS-PST-1PL
'I called the customer services, and as always we were made to listen to music
for 10 minutes.'²⁸
- (501) a. Üniversite öğrenci-ler-i-ne zor-la yemek ye-dir-di-ler.
university student-PL-CM-DAT force-with food eat-CAUS-PST-3PL
'They made university students eat food by force.'
- b. %Çin-in işgal alt-ı-nda tut-tuğ-u Doğu Türkistan
China-GEN invasion under-CM-LOC hold-NMLZ-ACC east Turkistan
bölge-si-nde bazı **üniversite öğrenci-ler-i** oruçlu-yken ... zor-la
region-CM-LOC some university student-PL-CM fasting-while force-with
yemek **ye-dir-il-di-ler**.
food eat-CAUS-PASS-PST-3PL
'In the eastern Turkistan region, held under Chinese invasion, some university
students were made to eat food by force while they were fasting.'²⁹

The same passivization possibility also holds when a finite clause is the embedded constituent. Consider (502) and (503).

- (502) a. Biz-e okul-da [ne mutlu Türk-üm di-yen-e]
we-DAT school-LOC what happy Turk-1SG say-REL-DAT
de-dir-(t)-ti-ler.
say-CAUS-(CAUS)-PST-3PL
'They made us say "how happy is he/she who says I am a Turk" in the school.'
- b. %Biz okul-da [ne mutlu Türk-üm di-yen-e]
we school-LOC what happy Turk-1SG say-REL-DAT
de-dir-(t)-il-di-k.
say-CAUS-(CAUS)-PASS-PST-1PL
'We were made to say "how happy is he/she who says I am a Turk" in the school.'
- (503) a. Son gelişmeler biz-e [sen topluluğ-un yeni başkan-ı
recent developments we-DAT [you society-GEN new head-POSS

²⁸<https://www.sikayetvar.com/telefon/720p>. Accessed on March 14, 2021.

²⁹https://www.tbmm.gov.tr/develop/owa/genel_kurul.clg_etir?pEid=33470. Accessed on December 24, 2018.

ol-acak-sın diye] düşün-dür-(t)-tü.
become-FUT-2SG DIYE] think-CAUS-(CAUS)-PST

‘Recent developments made us think that you would become the new head of the society.’

- b. %(Biz) [sen topluluğ-un yeni başkan-ı ol-acak-sın diye]
we [you society-GEN new head-POSS become-FUT-2SG DIYE]
düşün-dür-(t)-ül-dü-k.
think-CAUS-(CAUS)-PASS-PST-1PL

‘We were made to think that you would become the new head of the society.’

The data show that the dative causee can raise to become the grammatical subject when the embedded constituent is a finite clause and a pseudo-incorporated object, which do not receive case.

Examples from non-standard varieties of Turkish demonstrate that non-raising of the causee in standard Turkish does not warrant its treatment as an adjunct (*pace* Key 2013; Harley 2017a). This is because in standard Turkish, dative is nonstructural (or inert), as such is immune to passivization. In contrast, for nonstandard varieties, the dative is structural, thus can be the target of passivization.

Another interesting fact is that even speakers of nonstandard Turkish, who allow the raising of the dative Causee, disallow the passivization of the dative-marked IO, (504).

- (504) Çocuk-lar-a resim göster-di-m.
child-PL-DAT picture show-PST
‘I showed the children picture(s).’

- (505) *Çocuk-lar resim göster-il-di-ler.
child-PL picture show-PASS-PST-PL
‘The children were shown picture(s).’

- (506) Çocuk-lar-a resim göster-il-di.
child-PL-DAT picture show-PASS-PST
‘One showed children picture(s).’

This potentially follows from the structure Tonyalı (2015) proposes for IOs in Turkish, which she argues are actually PPs. Further evidence comes from depictive secondary

predicates.

Before I start with the discussion of depictives, it is worth emphasizing that depictives do not distinguish between arguments and adjuncts.³⁰ First, not all arguments can be modified by depictives. Thus, even if the Causee were to be not associated with depictives, it would not mean that it must be an adjunct. Consider the first object in English double-object constructions, which cannot normally be modified by a depictive secondary predicate (Williams 1980, Pylkkänen 2008:15, Bruening 2020:45).

(507) I₁ told John₂ the news drunk_{1/*2} (Pylkkänen 2008:15, (11a))

This does not mean that the first object in English is an adjunct. It can be raised to become a grammatical subject in the passive. Same thing happens in Arabic, where the IO can also become the subject, (508). Thus, depictive licensing is not a diagnostic for adjunct vs. argumenthood.

(508) varr-e Kamal xabar {*raxu / raxu-e}
showed-3F Kemal.M news {sick.M / sick-F}
'She₁ showed Kemal₂ the news sick_{1/*2}.'

Furthermore, even if depictives could be used as a diagnostic to pick out arguments in Turkish, Causee would fall in the category of arguments. This is because both dative and accusative causees can be modified by depictives.

(509) Accusative Causee

O₁ zavallı kadın-ı₂ aç aç_{1/2} koş-tur-du.
s/he poor woman-ACC hungry run-CAUS-PST
'S/he₁ made the poor woman₂ run hungry_{1/2}.'

(510) Dative Causee

a. Hiç insafı yok bu adamın, (This man has no conscience ...)

³⁰This is partially a response to a claim by an anonymous TU+6 reviewer: “dative causees resist modification by depictive secondary predicates” (as such dative causees are adjuncts, and not arguments). This claim is in fact empirically and theoretically not correct.

*pro*₁ zavallı kadın-a₂ bütün ev-i **aç aç**_{1/2} temizle-t-ti.
 poor woman-DAT whole house-ACC hungry clean-CAUS-PST
 ‘He₁ made the poor woman₂ clean the whole house hungry_{1/2}.’

b. *pro*₁ mektub-u biz-e₂ **sarhoş**_{1/2} yaz-dır-dı.
 letter-ACC we-DAT drunk write-CAUS-PST
 ‘S/he₁ made us₂ write the letter drunk_{1/2}.’

In fact, there are contexts in which a depictive is strongly (if not exclusively) associated with the Causee, and not the matrix subject.

(511) Biz-e {**alkollü** / **sarhoş**} araba kullan-dır-ma-mak için kocaman bir
 we-DAT {intoxicated / drunk} car drive-CAUS-NEG-INF for large a
 minibüs ayarla-dı.
 minibüs arrange-PST
 ‘He arranged a large minibus not to let us drive the car {intoxicated / drunk}.’³¹

In Turkish, the Causee contrasts with the IO of ditransitives in terms of depictive modification as well.

(512) O₁ Kemal-e₂ hediye-yi **çıplak**_{1/*2} göster-di.
 s/he Kemal-DAT gift-ACC naked show-PST
 ‘S/he₁ showed Kemal₂ the gift naked_{1/*2}.’

(513) O₁ Kemal-e₂ hediye-yi **yorgun argın**_{1/*2} yolla-dı.
 s/he Kemal-DAT gift-ACC exhausted send-PST
 ‘S/he₁ sent Kemal₂ the gift exhausted_{1/*2}.’

This again can be tied to passivization asymmetry noted above which also exhibits a contrast between dative-IO and dative-Causee; as such, it can also be said to follow from Tonyalı’s (2015) suggestion, in which the IO is treated as a PP.

4.3.3 Long-distance scrambling

The third piece of evidence comes from long-distance scrambling. Turkish exhibits argument-adjunct asymmetry in terms of long distance scrambling (Çakır 2020). Arguments, (514),

³¹adapted from <http://ilkedeninciler.blogspot.com/2013/07/aslnda-hicbir-seye-ihtiyacmz-yok4.html>. Accessed on January 20, 2021.

but not adjuncts, (515), can be scrambled.³² The judgments are given as ‘ok/*’ in Çakır (2020). I use the same notation, but to indicate contrasts in acceptability rather than absolute grammaticality judgements. To that end, I asked six native speakers to rate the Turkish sentences, and provided the results (with individual judgments, and the arithmetic mean). The informal survey confirms Çakır’s (2020) intuition, but in the form of a contrast between arguments and adjuncts.

- (514) Masa-yı Mustafa [Leyla-nın _ kır-dığ-ı]-nı bil-iyor.
 table-ACC Mustafa [Leyla-GEN break-PTCP-POSS]-ACC know-PROG
 ‘The table, Mustafa knows that Leyla broke _.’ (3, 4, 4, 3, 5, 4; **3.83**)
- (515) *Leyla tarafından Mustafa [masa-nın _ kır-ıl-dığ-ı]-nı bil-iyor.
 Leyla by Mustafa [table-GEN break-PASS-PTCP-POSS]-ACC know-PROG
 ‘By Leyla, Mustafa knows that the table was broken _.’
 (2, 3, 2, 3, 1, 1; **2**)³³

Crucially, the dative Causee can also be long-scrambled, (516), similar to the accusative Causee, (517) (noting that accusative is rated slightly higher than dative).

- (516) Dative Causee
- Kemal-e Mustafa [Leyla-nın masa-yı _ kır-dır-dığ-ı]-nı
 Kemal-DAT Mustafa [Leyla-GEN table-ACC break-CAUS-PTCP-POSS]-ACC
 bil-iyor.
 know-PROG
 ‘Mustafa knows that Leyla made Kemal broke the table.’ (3, 4, 3, 3, 4, 3; **3.33**)
- (517) Accusative Causee
- Çocuğ-u, Kemal dün _ koş-tur-du.
 child-ACC Kemal yesterday run-CAUS-PST
 ‘Kemal yesterday made the child run.’ (4, 4, 3, 3, 4, 4; **3.66**)

³²similar to other adjuncts discussed in Çakır 2020, e.g., *dün* ‘yesterday’, *hiddetle* ‘violently’ and other types of adjuncts.

³³Some speakers report a stronger contrast arises with an intonational break.

4.3.4 Island Constraints

Finally, Turkish exhibits an argument-adjunct asymmetry in terms of interpretation within islands (e.g. Arslan 1999; Kornfilt 2003; Görgülü 2006; Çakır 2016). It has been reported that interpretation of argumental *wh*-expressions in island structures is possible, (518), whereas that of adjunct *wh*-expressions is not, (519)-(520).³⁴

- (518) Sen [[kim-i davet ed-en] adam]-a kız-dı-n?
 you [[who-ACC invite do-REL] man]-DAT get.angry.at-PST-2SG
 ‘Who (x) is it such that you are angry at the man who invited x?’ (Çakır 2020:(3))
- (519) *Sen [[Ayşe-yi niye davet ed-en] adam]-a kız-dı-n?
 you [[Ayşe-ACC why invite do-REL] man]-DAT get.angry.at-PST-2SG
 ‘Why (x) is it such that you are angry at the man who invited Ayşe x?’ (Çakır 2020:(4))
- (520) *Sen [[Ayşe-yi kim için davet ed-en] adam]-a kız-dı-n?
 you [[Ayşe-ACC who for invite do-REL] man]-DAT get.angry.at-PST-2SG
 ‘For whom (x) is it such that you are angry at the man who invited Ayşe x?’

Causee *wh*-expressions can be interpreted in island structures, regardless of whether it is dative or accusative.

- (521) a. Sen [[kim-e kitap oku-t-an] adam]-a kız-dı-n?
 you [[who-DAT book read-CAUS-REL] man]-DAT get.angry.at-PST-2SG
 ‘Who (x) is it such that you are angry at the man who made x read book(s)?’
- b. Sen [[kim-i koş-tur-an] adam]-a kız-dı-n?
 you [[who-ACC run-CAUS-REL] man]-DAT get.angry.at-PST-2SG
 ‘Who (x) is it such that you are angry at the man who made x run?’

Put together, these diagnostics (clefting, passivization in non-standard Turkish, long-distance scrambling, and island constraints) demonstrate that the dative Causee behaves like an argument, and not an adjunct (contra Key 2013; Harley 2017a; Nie 2020).

³⁴Again, I believe ‘ok/*’ reflects a contrast in acceptability rather than absolute grammaticality judgments.

4.3.5 The overall structure of Turkish causatives

Combining the discussion about the size of the embedded structure and the status of the Causee, I propose the structure in (523) for Turkish causatives, in which the Causee is introduced in Spec, Voice_{CAUSEE}P as an argument. Generation of the Causee in Spec, Voice_{CAUSEE}P, rather than the canonical Spec, VoiceP reflects the distinct Causee θ -role. It also captures the inability of the causee to be inanimate and will serve as a useful tool to explain the impossibility of ‘by’-phrases in Turkish causatives.³⁵

³⁵Note that Causee θ -role is different from Alexiadou et al. 2006 use of Causer, which usually refers to natural forces such as ‘storm’, ‘earthquake’, ‘wind’. In Turkish, natural forces can be matrix subjects, (522a), but they are not possible as external arguments of the caused event, i.e. Causee, in Turkish, (522b).

- (522) a. Yağmur yangın-ı söndür-dü.
rain fire-ACC extinguish-PST
‘The rain extinguished the fire.’
b. #Tanrı yağmur-a yangın-ı söndür-t-tü.
God rain-DAT fire-ACC extinguish-CAUS-PST
‘God made the rain extinguish the fire.’

The same pattern holds for Instruments in Turkish: they are grammatical as matrix subjects, e.g. *The hammer broke the window*, but not as the Causee of the embedded event. Thus, as also noted in Key (2013, 188), the causee must be animate.

(523)

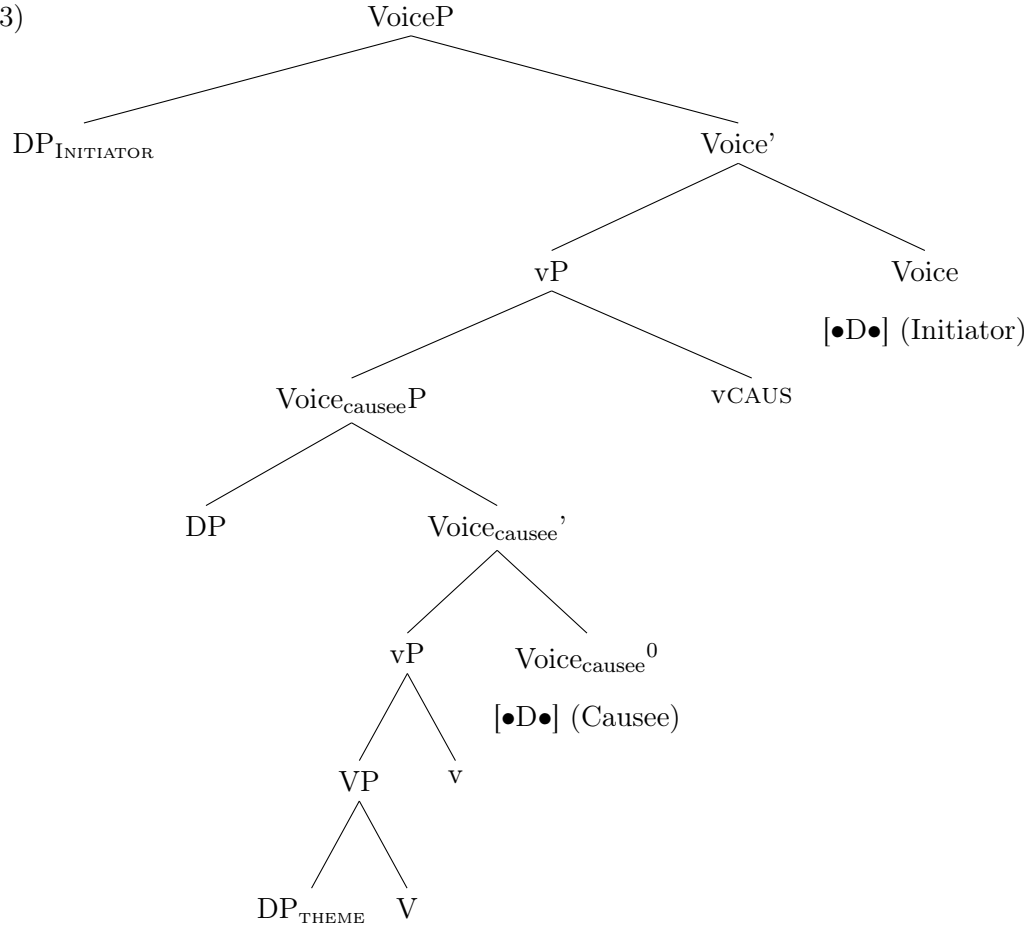

Recall that speakers of nonstandard varieties of Turkish allow raising of the dative when the embedded object is pseudo-incorporated, but not when it bears accusative case. This calls for an explanation. I suggest to capture this restriction with the hypothesis that whereas $\text{Voice}_{\text{CAUSEE}}$ is the locus of DAT to the Causee in its specifier, ACC case on the embedded object is assigned by matrix Voice. In passive structures, Voice cannot assign ACC to the embedded grammatical object, as illustrated in (524a), for the sentence in (524b).

(524) a.

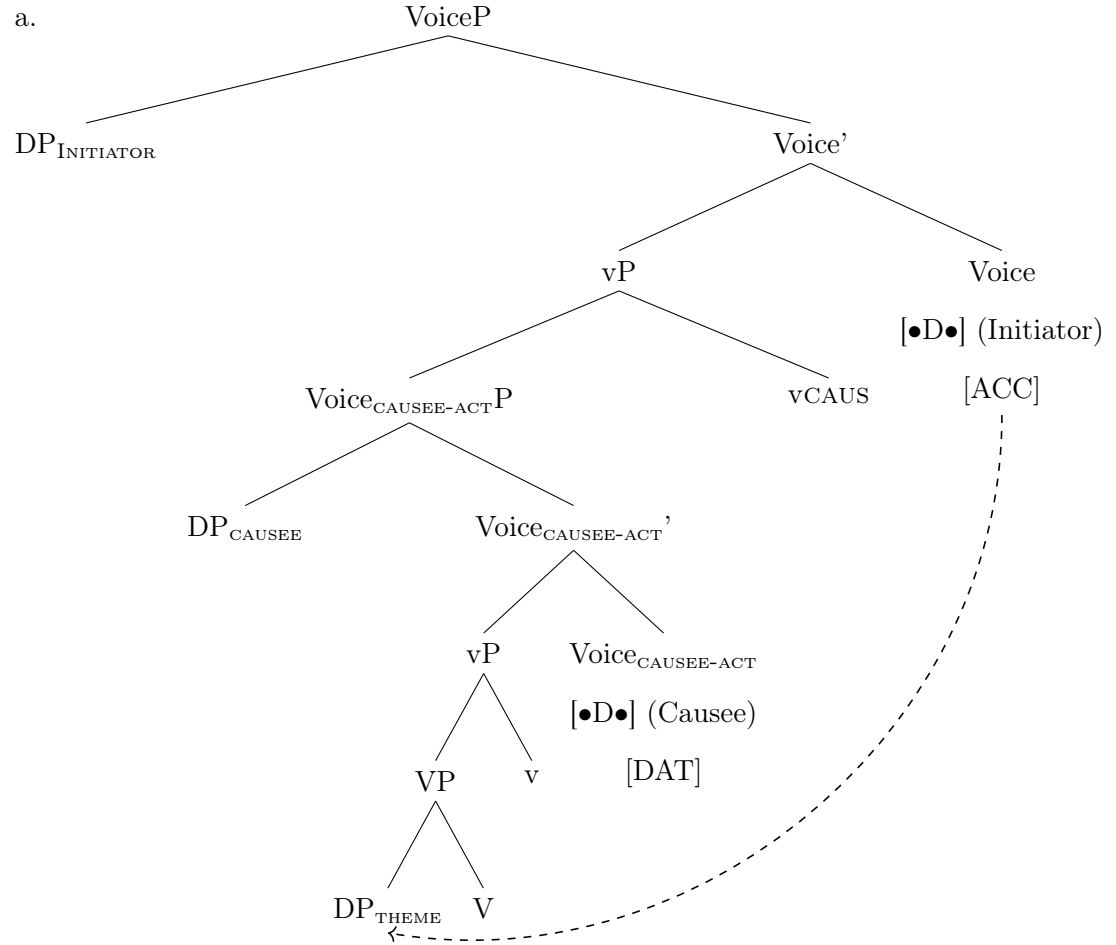

b. Biz-e okul-da kitab-ı oku-t-tu-lar.
 we-DAT school-LOC book-ACC study-CAUS-PST-3PL
 ‘They made us read the book at school.’

When matrix Voice is passive, the Causee raises to become the grammatical subject, but matrix passive Voice cannot assign ACC case to the embedded object, thus the ungrammaticality of (526a) represented in (525). On the other hand, when the object is pseudo-incorporated, i.e. [NP V] as in (526b), rather than [DP V], there is no argument that needs to be assigned case.

(525)

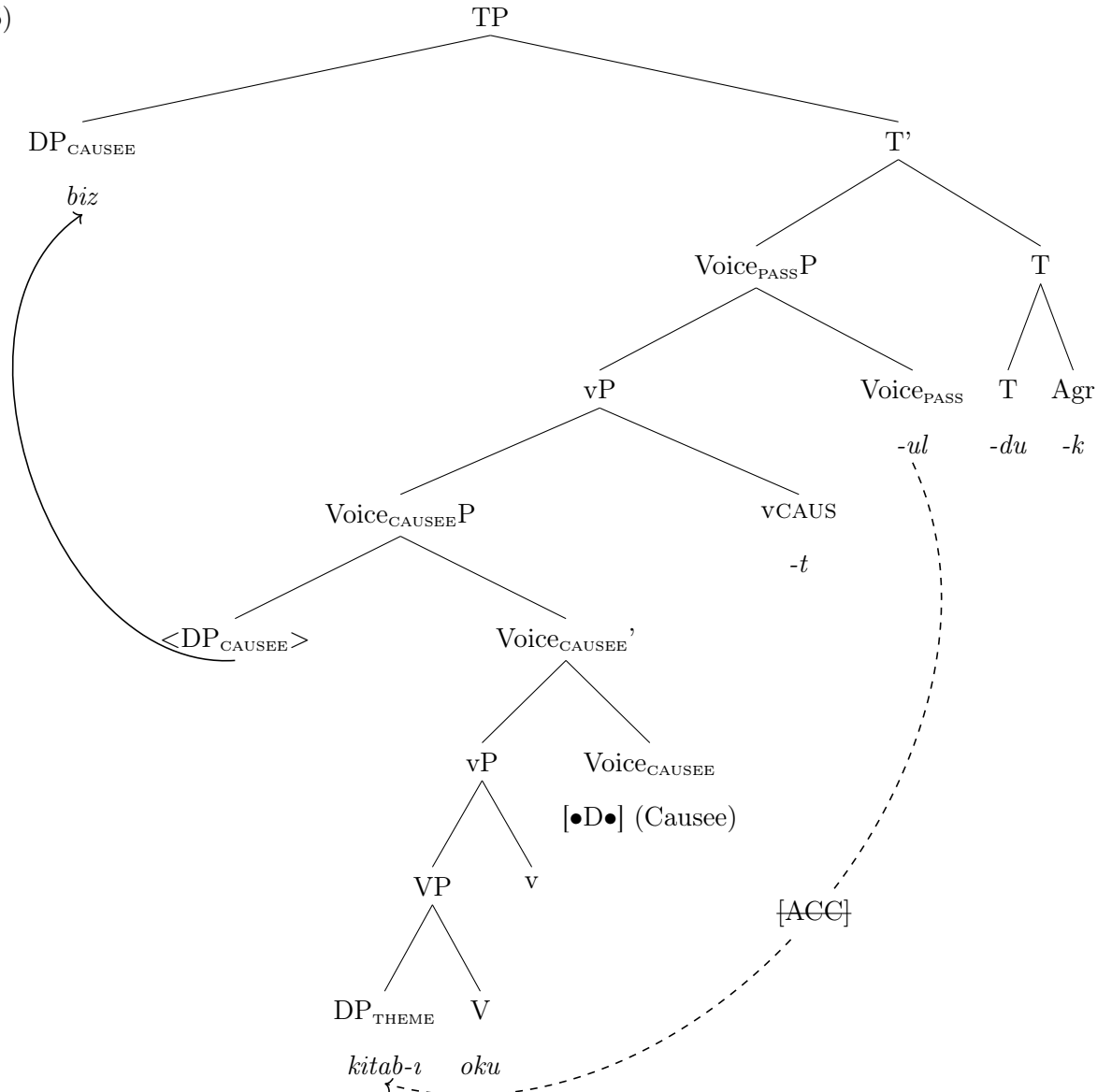

- (526) a. *Biz okul-da kitab-ı oku-t-ul-du-k.
we school-LOC book-ACC study-CAUS-PASS-PST-1PL
'We were made to read the book at school.'
- b. Biz okul-da kitap oku-t-ul-du-k.
we school-LOC book study-CAUS-PASS-PST-1PL
'We were made to read book(s) at school.'

Now that we have examined the status of the overt causee, I next discuss the status of null

causee and argue that it is not syntactically projected, but is interpreted existentially like a missing ‘by’-phrase.

4.4 The interpretation of the null causee

I first provide arguments to show that the null causee is not a case of *pro*-drop.³⁶ As also discussed in Key 2013, a *pro*-dropped argument in Turkish requires an established discourse topic with which the dropped argument co-refers. This is illustrated in (527).³⁷

- (527) Kapı-yı anahtar-la aç-tı.
 door-ACC key-with open-PST
 ‘(S/he) opened the door with a key.’ ← *requires established topic*
 # (Someone/ some people) opened the door with a key.
 # The door was opened with a key.

Secondly, whereas an implicit agent of passive can license sluicing, (528), a null pronoun (*pro*-dropped argument) may not, (529).

- (528) Kapı anahtar-la aç-ıl-dı, ama kim tarafından bil-m-iyor-um.
 door key-with open-PASS-PST but who by know-NEG-PROG-1SG
 ‘The door was opened with a key, but I don’t know who by.’
- (529) Kapı-yı anahtar-la aç-tı, #ama kim bil-m-iyor-um.
 door-ACC key-with open-PST but who know-NEG-PROG-1SG
 ‘(S/he) opened the door with a key, #but I don’t know who.’

The null causee is interpreted as existential (like a missing ‘by’-phrase), similar to ‘someone’ or ‘some people’, rather than pronominal (like a *pro*-dropped argument), (530).

³⁶This claim should not be taken to mean that the null causee can never be interpreted as a null *pro*. It can indeed be *pro*-dropped when it is an established topic in the discourse. We will focus on out-of-blue contexts to circumvent *pro*-drop interpretations.

³⁷Stromdahl and Nematova 2019b argue that in Uzbek an unpronounced causee can have an existential interpretation, but can still be bound by a *c*-commanding quantifier when it is unpronounced. They take this to suggest that the null causee *can* also be introduced as a null *pro* in Uzbek. I was not able to replicate the examples in Turkish. Thus, I leave that aside.

- (530) a. Hasan araba-yı yıka-t-tı.
 Hasan car-ACC wash-CAUS-PST
 YES: ‘Hasan made *someone/some people* wash the car.’
 NO: ‘Hasan made *him/her/them* wash the car.’
- b. Kadın et-i kes-tir-di.
 woman meat-ACC cut-CAUS-PST
 YES: ‘She made *someone/some people* cut the meat.’
 NO: ‘She made *him/her/them* cut the meat.’ (based on Özkaragöz 1986:118)

The next question is whether the existentially interpreted null causee is projected or not. In other words, does it have an active structure as in (531), or a passive structure, (532)? I use binding, depictive licensing, (non)passivizable idioms and sluicing to argue for the latter structure in the case of a null causee.

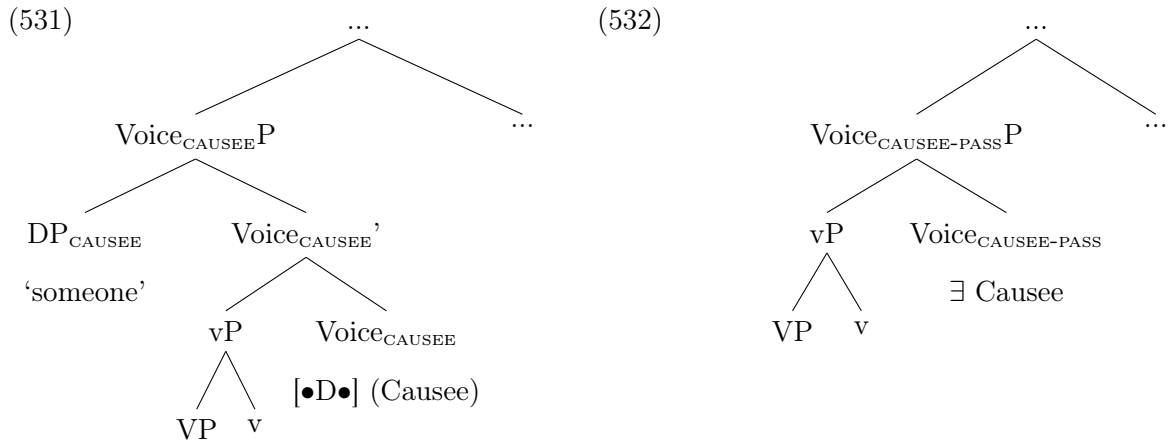

4.4.1 Nonpassivizable idioms

Nonpassivizable idioms are one diagnostic for active-passive alternation (cf. Kayne 1975; Folli and Harley 2007). Turkish has a class of idioms which lose their idiomatic interpretation under passivization, as illustrated in (533).³⁸

- (533) a. kemal ayva-yı ye-di.
 Kemal quince-ACC eat-PST
 ‘Kemal got into trouble.’ (lit. ate the quince)

³⁸Another idiom which shows the same pattern is *kafasını dağıtmak* ‘take one’s mind off things’.

- b. Ayva (Kemal tarafından) ye-n-di.
 quince Kemal by eat-PASS-PST
 YES: 'The quince was eaten (by Kemal).'
- NO: 'Kemal got into trouble.'

These idioms may occur in causatives only in the presence of a causee.

- (534) a. Valla bu oğlan ban-a şimdiden ayva-yı ye-dir-di.
 honestly this boy I-DAT already quince-ACC eat-CAUS-PST
 'Honestly this boy already got me into trouble.'³⁹
- b. Valla bu oğlan şimdiden ayva-yı ye-dir-di.
 honestly this boy already quince-ACC eat-CAUS-PST
 YES: 'Honestly this boy already had someone eat the quince.'
- NO: 'Honestly this boy already had someone get into trouble.'

Idioms of this sort contrast with passivizable idioms, e.g. *baklayı (ağızdan) çıkar-* 'lit: to take out the bean out of the mouth', illustrated in (535).

- (535) a. Sonunda bakla-yı ağız-dan çıkar-dı.
 finally bean-ACC mouth-ABL take.out-PST
 'S/he finally disclosed the secret.'
- b. B20 toplantı-sın-da bakla ağız-dan çıkar-ıl-dı
 B20 meeting-CM-LOC bean mouth-ABL take.out-PASS-PST
 'The secret was disclosed at the B20 meeting.'⁴⁰

These idioms impose no restriction regarding the overt presence of a causee.

- (536) a. En sonunda bakla-yı çıkar-tır-dı ban-a.
 very finally bean-ACC take.out-CAUS-CAUS-PST I-DAT
 'Eventually s/he made me disclose the secret.'⁴¹

³⁹<https://www.kadinlarkulubu.com/forum/threads/2010-ocak-anneleri.334578/page-979> Accessed on March 17, 2020.

⁴⁰<http://www.cumhuriyet.com.tr/koseyazisi/362333/avrupaya-santaj.html> Accessed on March 19, 2020.

⁴¹<http://www.patronlardunyasi.com/haber/-Vay-beee-Kadinlar-ustsuz-/66582>. Accessed on March 19, 2020.

As rightly argued in Key (2013, 231), the repetition of causative suffixes does not unambiguously yield a multiple causative interpretation. Some instances purely result in emphasis and focus. The second causative morpheme in this example is of this nature.

- b. Anne-ler eninde sonunda bakla-yı ağız-dan
 mother-PL eventually bean-ACC mouth-ABL
 çıkar-t-(tır)-ır-lar.
 take.out-CAUS-(CAUS)-AOR-PL
 ‘Mothers always make someone disclose the secret one way or another.’

4.4.2 Sluicing

As another potential diagnostic, sluicing provides only a partial answer since Turkish causatives do not allow the passive morphology or ‘by’-phrases, which are normally used to introduce the external arguments in canonical passives.

Discussion of sluicing requires some background about beneficiaries in causatives, and how they interact with the Causee. As background, it is possible to causativize an underlyingly transitive clause which also contains a beneficiary, as in (537a). When the dative-marked argument is overtly realized, the sentence is ambiguous, as illustrated in (537b). To disambiguate, the beneficiary can be introduced as a PP, which allows only the reading in which the causee is interpreted existentially, (537c).

- (537) a. Ben arkadaş-ım-a fotokopi çek-ti-m.
 I friend-my-DAT photocopy pull-PST-1SG
 ‘I xeroxed a paper/papers for my friend.’
- b. Ben arkadaş-ım-a fotokopi çek-tir-di-m.
 I friend-my-DAT photocopy pull-CAUS-PST-1SG
 YES: ‘I had my friend to xerox a paper/papers (for someone)’
 YES: ‘I had someone xerox a paper/papers for my friend.’ (adapted from Aydın and Kuribayashi 2008:55)
- c. Ben arkadaş-ım için fotokopi çek-tir-di-m.
 I friend-my for photocopy pull-CAUS-PST-1SG
 NO: ‘I had my friend to xerox a paper/papers (for someone)’
 YES: ‘I had someone xerox a paper/papers for my friend.’

Given this background, consider (538a) in which the DP remnant may target the causee. Moreover, the remnant can target the beneficiary whether it is realized as a DP or PP, as in (538a) and (538b), respectively.

- (538) a. Araba-yı birisi-ne yıka-t-tı, ama kim-e bil-mi-yor-um.
 car-ACC someone-DAT wash-CAUS-PST but who-DAT know-NEG-PROG-1SG
 YES: ‘S/he had someone wash the car, but I don’t know whom.’
 YES: ‘S/he had the car washed for someone, but I don’t know for whom.’
- b. Araba-yı birisi için yıka-t-tı, ama kim için bil-mi-yor-um.
 car-ACC someone for wash-CAUS-PST but who for know-NEG-PROG-1SG
 ‘S/he had the car washed for someone, but I don’t know for whom.’

The antecedent clause (539) contains an individual with an established identity, i.e. *Leyla*, which is ambiguous between a beneficiary and a causee. The anomaly of the first two interpretations indicate that *Leyla* may indeed be interpreted as beneficiary or causee, as such cannot be targeted by the remnant. (539-iii) shows that a potential interpretation in which the null causee is targeted with a DP remnant is not available.

- (539) Araba-yı Leyla-ya yıka-t-tı, ama kim-e bil-mi-yor-um.
 car-ACC Leyla-DAT wash-CAUS-PST but who-DAT know-NEG-PROG-1SG
- i. ‘S/he had the car washed for Leyla, #but I don’t know for whom.’
 ii. ‘S/he had Leyla wash the car, #but I don’t know who.’
 iii. *‘S/he had someone wash the car for Leyla, but I don’t know who.’

A clearer contrast comes from cases in which the antecedent involves a PP beneficiary, and the remnant in the correlate is realized as a DP, as in (540). The null element is necessarily the causee since the beneficiary is expressed as a PP. As expected, in (541), the PP remnant cannot target it either.

- (540) Araba-yı Leyla için yıka-t-tı, ama kim-e bil-mi-yor-um.
 car-ACC Leyla for wash-CAUS-PST but who-DAT know-NEG-PROG-1SG
- i. ‘S/he had the car washed for Leyla, #but I don’t know for whom.’
 ii. *‘S/he had someone wash the car for Leyla, but don’t know whom.’
- (541) Araba-yı Leyla için yıka-t-tı, #ama kim için bil-mi-yor-um.
 car-ACC Leyla for wash-CAUS-PST but who for know-NEG-PROG-1SG
 ‘S/he had the car washed for Leyla, #but I don’t know for whom.’

The unavailable readings (539-iii) and (540-ii) indicate that the causee is not projected

in Spec, Voice_{CAUSEE}P, as such cannot be targeted by the DP remnant for sluicing purposes. This points that causee-less causatives are not active for sluicing.⁴²

Taken together, these two diagnostics demonstrate an active-passive alternation in Turkish causatives (thus also rule out an alternative analysis along the lines of active existential in Šereikaitė 2020). With an overt causee, introduced as an argument, the embedded structure exhibits an active structure. In the absence of the causee, on the other hand, it behaves like passive. Given this backdrop, the difference between Japanese and Turkish causatives would not be about whether the Causee is argument or adjunct, rather about the causative construction shows active-passive alternation. Of the two, only Turkish exhibits a passive structure, thus allows the causee to be omitted and interpreted existentially.

This conclusion brings along some predictions with respect to anaphor binding and secondary predicate licensing. I examine them each in turn.

4.4.3 Anaphoric and pronominal binding

As discussed in Chapter 2, in Turkish anaphors require a projected binder. Therefore, binding by the implicit thematic subject in the passive is impossible.

- (542) a. Çocuk-lar ödev-i birbirleri için yap-tı-lar.
 child-PL homework-ACC each.other for do-PST-PL
 ‘The children did the homework for each other.’
- b. *Ödev birbirleri için yap-ıl-dı.
 homework each.other for do-PASS-PST
 ‘The homework was done for each other.’

In the presence of a ‘by’-phrase, binding becomes possible under certain conditions. As noted in Pesetsky 1995, PP verb phrase adjuncts behave as c-commanding rightwards, thus we expect the DP in the ‘by’-phrase to be able to bind a reciprocal in a PP to its right. This is correct:

⁴²Ideally, for a complete perspective, we would expect to be able to target the unpronounced causee with a PP remnant in the form of a ‘by’-phrase, but Turkish does not have this strategy. See below for the discussion of this point.

- (543) Ödev çocuk-lar tarafından birbirleri için yap-ıl-dı.
 homework child-PL by each.other for do-PASS-PST
 ‘The homework was done by the children for each other.’

Binding leftwards, in contrast, is not possible through this mechanism. However, there is an additional source for leftward binding. As discussed by Kural 1992 and Öztürk 2005 (see also Kornfilt 2005), Turkish leftward scrambling may reconstruct in the presence of contrastive focus. Notably, it is not the scrambled element itself that is focused, but rather an element that is scrambled over. The following examples illustrate. In (544a), the theme ‘picture’ and the location ‘in its frame’ are in their base orders, and ‘picture’ can bind the possessive pronoun. Scrambling ‘in its frame’ over ‘picture’ in (544b) eliminates the bound interpretation, but this interpretation is restored in (544c) through contrastive focus on ‘I’.

- (544) a. Resm- i_i çerçeve-sin- i_j -e koy-du-m.
 picture-ACC frame-3SG-DAT put-PST-1SG
 ‘I put the picture in its frame.’
- b. Çerçeve-sin- j / $*i$ -e resm- i_i koy-du-m.
 frame-3SG-DAT picture-ACC put-PST-1SG
 ‘I put the picture in his/*its frame.’
- c. Çerçeve-sin- i_j -e resm- i_i BEN koy-du-m.
 frame-3SG-DAT picture-ACC I put-PST-1SG
 ‘I put the picture in his/its frame.’ (Öztürk 2005, 154-155)

Sentences in (545) provide another illustration of this pattern. In (545a), the subject QP binds the possessive pronoun in the object position, thus the bound-variable interpretation (in addition to the other reading in which the pronoun gets its referent from the context). In the intended reading of (545b), the implicit agent of the passive cannot bind the pronoun, thus forces a disjoint-reference reading. Similarly, in (545c), the DP in the ‘by’-phrase is not able to bind the pronoun to its left. (545d) shows that leftward binding may reconstruct in the presence of a contrastive focus.

- (545) a. Her yazar- j kitab- 1_j / k -ni oku-du.
 every author book-3POSS-ACC read-CAUS-PST
 ‘Every author- j read his- j/k /her- j/k book.’

- b. *Kitab-1_{*j/k} oku-n-du.*
 book-3POSS read-PASS-PST
 YES: ‘His/her book was read.’
 NO: ‘His_j/her_j book was read (by the author_j of that book).’
- c. *Kitab-1_{*j/k} her yazar_j tarafından oku-n-du.*
 book-3POSS every author by read-PASS-PST
 ‘His_{*j/k}/her_{*j/k} book was read by every author_j.’
- d. *Kitab-1_{j/k} her yazar_j tarafından DÜN oku-n-du.*
 book-3POSS every author by YESTERDAY read-PASS-PST
 ‘His_{j/k}/her_{j/k} book was read YESTERDAY by every author_j.’

Similarly, in (546), scrambling of ‘each other’ causes a Condition A violation, but addition of intervening focused ‘yesterday’ in (546c) allows reconstruction, and hence the necessary binding.

- (546) a. *Adam-lar birbirleri-ni gör-müş.*
 men-PL each.other-ACC see-EVID.PST
 ‘The men saw each other.’
- b. ** birbirleri-ni_i adam-lar_i gör-müş.*
 each.other-ACC men-PL see-EVID.PST
 ‘The men saw each other.’
- c. *birbirleri-ni_i adam-lar_i DÜN gör-müş.*
 each.other-ACC men-PL YESTERDAY see-EVID.PST
 ‘The men saw each other YESTERDAY.’ (Öztürk 2005, 153-154)

Given this background, consider (547). This sentence involves scrambling of ‘for each other’ over ‘by the children’, and is ungrammatical with neutral intonation. With the indicated contrastive focus on ‘by the children’, though, reconstruction of the scrambled ‘for each other’ becomes possible, and the sentence is grammatical.

- (547) *Ödev birbirleri için ÇOCUK-LAR TARAFINDAN yap-ıl-dı.*
 homework each.other for CHILD-PL BY do-PASS-PST
 ‘The homework was done for each other BY THE CHILDREN.’

Turning to causatives, the reciprocal can be bound either by the matrix Causer, as in

(548a), or the overt causee of the embedded event, (548b), depending on which antecedent matches the reciprocal in ϕ -features.

- (548) a. Prens-ler_i köle-ye birbirleri_i-ni öv-dür-dü-ler.
 prince-PL slave-DAT each.other-ACC praise-CAUS-PST-PL
 ‘The princes_i made the slave praise each other_i.’
- b. Prens köle-ler_j-e birbirleri_j-ni öv-dür-dü.
 prince slave-PL-DAT each.other-ACC praise-CAUS-PST
 ‘The prince made the slaves_j praise each other_j.’

When both the causer and causee are licit antecedents, the sentence is ambiguous.

- (549) Prens-ler_i köle-ler_j-e birbirleri_{i/j}-ni öv-dür-dü-ler.
 prince-PL slave-DAT each.other-ACC praise-CAUS-PST-PL
- i. ‘The princes_i made the slaves praise each other_i.’
- ii. ‘The princes made the slaves_j praise each other_j.’

Crucially, a null causee cannot be a licit binder for a reciprocal, further supporting its status as the implicit thematic Causee in the passive causative. Consider (550).

- (550) *Prens birbirleri-ni öv-dür-dü.
 prince each.other-ACC praise-CAUS-PST
 ‘The prince had some people praise each other.’

Another example follows in (551b), built on the ambiguous example in (551a). In addition to demonstrating that the reciprocal cannot be bound by a null causee in the intended reading (b-i), (551a) shows that the reciprocal cannot be bound by a null beneficiary either in reading (b-ii).

- (551) a. Ben arkadaş-ım-a fotokopi çek-tir-di-m.
 I friend-my-DAT photocopy pull-CAUS-PST-1SG
 YES: ‘I had someone/some people xerox a paper/papers for my friend.’
 YES: ‘I had my friend to xerox a paper/papers (for someone/some people).’
- b. *Ben arkadaş-ım-a birbirleri için fotokopi çek-tir-di-m.
 I friend-my-DAT each.other for photocopy pull-CAUS-PST-1SG
 i: ‘I had some people_i xerox a paper/papers for my friend_k for each other_{*i/*k}.’
 ii: ‘I had my friend_i xerox a paper/papers (for some people_k’s each other_{*i/*k}).’

Turkish causatives exhibit the same binding mechanism and properties as in other parts of the language.

For instance, similar to (546), in causatives as well, scrambling of ‘each other’ causes a Condition A violation, but addition of intervening focused ‘yesterday’ in (552c) allows reconstruction, and hence the necessary binding.

- (552) a. Adam-lar-a birbirleri-ni öv-dür-dü.
 men-PL-DAT each.other-ACC praise-CAUS-PST
 ‘S/he made the men praise each other.’
- b. * birbirleri-ni_i adam-lar-a_i öv-dür-dü.
 each.other-ACC men-PL-DAT praise-CAUS-PST
 ‘S/he made the men praise each other.’
- c. birbirleri-ni_i adam-lar-a_i DÜN öv-dür-dü.
 each.other-ACC men-PL-DAT YESTERDAY praise-CAUS-PST
 ‘S/he made the men praise each other YESTERDAY.’

Pronominal binding also follows the same pattern. In (553), the causee ‘every author’ and the embedded theme ‘his/her book’ are in their base orders, and the causee can bind the possessive pronoun. Scrambling ‘his/her book’ over ‘every author’ in (553c) eliminates the bound interpretation, but this interpretation is restored in (553d) through the contrastive focus on ‘yesterday’.⁴³

- (553) a. Organizatör_i her yazar_j-a kitab-_{i/k/j}-nı oku-t-tu.
 organizer every author-DAT book-3POSS-ACC read-CAUS-PST
 ‘The organizer_i made every author_j read his_{i/k/j}/her_{i/k/j} book.’
- b. Organizatör_i kitab-_{i/k/*j}-nı oku-t-tu.
 organizer book-3POSS-ACC read-CAUS-PST
 ‘The organizer_i had his_{i/k/*j}/her_{i/k/*j} book read.’
- c. Organizatör_i kitab-_{i/k/*j}-nı her yazar_j-a oku-t-tu.
 organizer book-3POSS-ACC every author-DAT read-CAUS-PST
 ‘The organizer_i had his_{i/k/*j}/her_{i/k/*j} book read by every author_j.’

⁴³The binding patterns also highlight that binding is not a reliable test in determining whether the causee is an argument or adjunct (contra Stromdahl and Nematova 2019b), since the Causee and ‘by’-phrases pattern alike in that both can rightward binding, but not leftward binding unless there is contrastive focus. This is so despite the Causee being an argument and ‘by’-phrase an adjunct (see the above discussion in this chapter).

- d. Organizatör_i kitab-_{i/k/j}-ni her yazar_j-a DÜN oku-t-tu.
 organizer book-3POSS-ACC every author-DAT YESTERDAY read-CAUS-PST
 ‘The organizer_i had his_{i/k/j}/her_{i/k/j} book read by every author_j YESTERDAY.’

Reflexives pattern like reciprocals in terms of requiring a projected binder (leaving aside the configurations in which they function as logophors, see Chapter 1). (554) shows that both an overt causee or the matrix causer are potential binder for the reflexive.

- (554) a. Ali_i Arda_j’-ya kendi_{i/j}-ni savun-dur-du.
 Ali Arda-DAT him(self)-ACC defend-CAUS-PST
 i. ‘Ali made Arda_j defend himself_j.’
 ii. ‘Ali_i made Arda defend him_i.’⁴⁴ (Çetinoğlu et al., 2008, 6a)
- b. Ali_i misafir-ler-e kendi_i-ni savun-dur-du.
 Ali guest-PL-DAT him(self)-ACC praise-CAUS-PST
 ‘Ali_i made the guests praise him_i.’

On the other hand, a null causee cannot bind the reflexive, indicating that it is not projected.

- (555) Ali_i kendi_{i/*j}-ni savun-dur-du.
 Ali him(self)-ACC defend-CAUS-PST
 YES: ‘Ali made himself defended.’
 NO: ‘Ali made someone defend himself.’

The contrasts so far illustrate that an overt causee may enter a binding relation, whereas a null causee may not.

The inability of a null causee to refer to a subsequent pronoun also indicates that it is not projected. Consider the contrast between (556a) and (556b).

- (556) a. Tamirci_i-ye araba-yı tamir et-tir-di-m. *pro_i* çok iyi iş yap-tı.
 repairman-DAT car-ACC repair do-CAUS-PST-1SG very good job do-PST
 ‘I made the repairman_i repair the car. S/he_i did a very good job.’
- b. Araba-yı tamir et-tir-di-m. #*pro_i* çok iyi iş yap-tı.
 car-ACC repair do-CAUS-PST-1SG very good job do-PST
 ‘I had the car repaired. #S/he_i did a very good job.’

⁴⁴I modified the presentation of the translation.

Moreover, I demonstrate that the null causee in multiple causatives behaves also as not projected. As background, in Turkish causatives, it is not possible to overtly realize a second dative-case marked argument, regardless of its function as a causee or a benefactor. This restriction holds in single as well as multiple morphological causatives, as shown in (557a) and (557b), respectively.

- (557) a. *Ben arkadaş-ım-a fotokopici-ye fotokopi çek-tir-di-m.
 I friend-my-DAT copy shop-DAT photocopy pull-CAUS-PST-1SG
 ‘I had a paper/papers photocopied by a copy shopper.’ (Aydın and Kuribayashi 2008:55)
- b. *Ben arkadaş-ım-a fotokopici-ye fotokopi çek-tir-t-ti-m.
 I friend-my-DAT copy shop-DAT photocopy pull-CAUS-CAUS-PST-1SG
- i. *‘I had my friend make the copy shopper xerox a paper/papers.’
- ii. *‘I had the copy shopper xerox a paper/papers for my friend.’

However, it is possible to introduce the beneficiary as a PP, in which case the remaining DP is interpreted as the causee. Consider (558).^{45,46}

⁴⁵(558b) can also have the meaning in (558a), thus be another illustration of repetition of causative suffixes not yielding a multiple causative interpretation.

⁴⁶The example (i) below presents another instance in which two dative-case marked arguments are ruled out. It shows that in a ditransitive construction in which the goal (*teacher*) receives dative case, the beneficiary cannot.

- (i) Hediye-yi Tokay için/*Tokay-a hoca-ya ver-di-m.
 present-ACC Tokay for/Tokay-DAT teacher-DAT give-PST-1SG
 ‘I gave the present to the teacher for Tokay.’ (Knecht 1986:104)

This contrasts with the ECM construction in (ii), in which both the embedded theme and the ECM subject can be accusative-case marked.

- (ii) John Mary-i Bill-i gör-dü san-dı.
 John Mary-ACC Bill-ACC see-PST think-PST
 ‘John thought Mary loved Bill.’ (John thought Mary to love Bill) (Göksel 1993: 198)

In fact, it is also possible to have two adjacent dative-case marked arguments, as shown in (iii). This indicates that we are not dealing with a constraint against the co-occurrence of two adjacent dative arguments linearly.

- (iii) Ben Leyla-ya kitab-a bak-ma-sı-nı söyle-di-m.
 I Leyla-DAT book-DAT look-NMLZ-POSS-ACC tell-PST-1SG
 ‘I told Leyla to look at the book.’

Furthermore, as noted in (Knecht 1986), (iv-b) is also possible, with a restriction on the interpretation. Knecht says that some speakers permit this. I believe it is in fact permitted by most speakers. The first dative-case marked NP is interpreted as the benefactive, whereas the second NP as the causee. This

- (558) a. Ben arkadaş-ım için fotokopici-ye fotokopi çek-tir-di-m.
 I friend-my for copy shop-DAT photocopy pull-CAUS-PST-1SG
 ‘I made the copy shopper xerox a paper/papers for my friend.’
- b. Ben arkadaş-ım için fotokopici-ye fotokopi çek-tir-t-ti-m.
 I friend-my for copy shop-DAT photocopy pull-CAUS-CAUS-PST-1SG
- i. ‘I made the copy shopper make someone (e.g. an employee) xerox a paper/papers for my friend.’
- ii. ‘I made someone make the copy shopper xerox a paper/papers for my friend.’
- iii. *‘I made my friend xerox a paper/papers for the copy shopper.’
- iv. *‘I had my friend make the copy shopper xerox a paper/papers.’

Given this background, consider (559). The matrix causer ‘student’ and the higher causee ‘teacher’ cannot serve as antecedents for the reciprocal. The remaining potential antecedent is the null causee, which also may not bind the reciprocal, in line with its status as not projected.

- (559) *Öğrenci öğretmen-e birbirleri için fotokopi çek-tir-t-ti.
 student teacher-DAT each.other for xerox pull-CAUS-CAUS-PST-1SG
 ‘The student made [the teacher make [some people xerox a paper/papers for each other]].’

When the sentence contains a licit antecedent, however, it becomes grammatical.

observation seems to be quite robust, since even in potentially salient contexts, the first NP cannot be interpreted as the causee, as in (iv-c), (unless for instance, the second NP (*the girl*) in (iv-c) is expressed as a PP, such as *kız için* ‘for the girl’).

- (iv) a. Ben Ali-ye et-i kız için kes-tir-di-m.
 I Ali-DAT meat-ACC girl for cut-CAUS-PST
 ‘I made Ali cut the meat for the girl.’
- b. Ben kız-a et-i Ali-ye kes-tir-di-m.
 I girl-DAT meat-ACC Ali-DAT cut-CAUS-PST
- i. ‘I made Ali cut the meat for the girl.’
- ii. *‘I made the girl cut the meat for Ali.’ (Knecht 1986:104)
- c. Ben kasab-a et-i kız-a kes-tir-di-m.
 I butcher-DAT meat-ACC girl-DAT cut-CAUS-PST
- i. ‘I made the girl cut the meat for the butcher.’
- ii. *‘I made the butcher cut the meat for the girl.’

An analysis along the lines of Richards’s (2010) *Distinctness* for this restriction in Turkish seems promising. I leave this issue for future research.

- (560) Öğrenci öğretmen-ler-e birbirleri için fotokopi çek-tir-t-ti.
 student teacher-PL-DAT each.other for xerox pull-CAUS-CAUS-PST
 ‘The student made [the teachers make [someone/some people xerox a paper/papers]
 for each other].’

Let us finally examine the behavior of depictives.

4.4.4 Depictive licensing

Depictives exhibit the same behavior. As discussed in Chapter 2, they need a projected binder in Turkish. Consider (561).

- (561) a. Ahmet araba-yı sarhoş sür-dü.
 Ahmet car-ACC drunk drive-PST
 ‘Ahmet drove the car drunk.’
 b. *Araba (Ahmet tarafından) sarhoş sür-ül-dü.
 car Ahmet by drunk drive-PASS-PST
 ‘The car was driven drunk (by Ahmet).’

Similarly, an overt causee is a potential licenser for depictives (as already shown in §4.3, and illustrated here with more examples).

- (562) a. Ahmet_i Kemal_k-e araba-yı sarhoş_{i/k} sür-dür-dü.
 Ahmet Kemal-DAT car-ACC drunk drive-CAUS-PST
 ‘Ahmet_i had Kemal_k drive the car drunk_{i/k}.’
 b. Ahmet_i Kemal_k-e mektub-u yorgun_{i/k} yaz-dır-dı.
 Ahmet Kemal-DAT letter-ACC tired write-PASS-PST
 ‘Ahmet_i had Kemal_k write the letter tired_{i/k}.’

However, a null causee cannot license depictives.

- (563) a. Ahmet araba-yı sarhoş sür-dür-dü.
 Ahmet car-ACC drunk drive-CAUS-PST
 ‘Ahmet_i had someone_k drive the car drunk_{i/*k}.’
 b. Ahmet mektub-u yorgun yaz-dır-dı.
 Ahmet letter-ACC tired write-PASS-PST
 ‘Ahmet_i had someone_k write the letter tired_{i/*k}.’

Depictives further demonstrate that the null causee is not projected.

4.4.5 The structures for overt and null causee

The discussion has demonstrated that causative constructions with an overt causee embed an active structure, in which the causee is projected as an argument in Spec, Voice_{CAUSEE}P, (564). On the other hand, in Causee-less sentences, the embedded structure has a passive syntax, in which the causee is not projected, (565).

(564) Causatives with overt causee

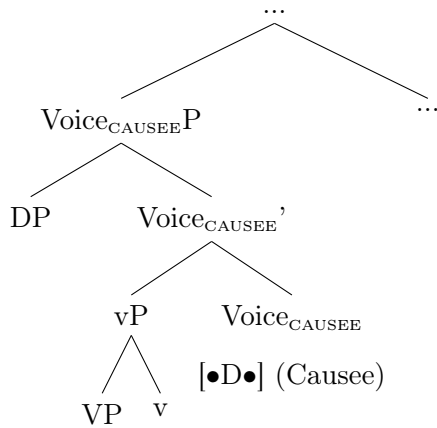

(565) Causatives with null causee

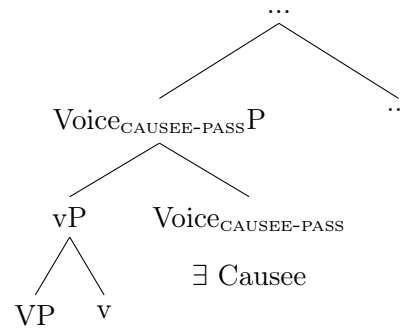

The structure for a multiple causative such as (560), repeated here as (566), is provided in (567).

(566) Öğrenci öğretmen-ler-e birbirleri için fotokopi çek-tir-t-ti.
 student teacher-PL-DAT each.other for xerox pull-CAUS-CAUS-PST
 ‘The student made [the teachers make [someone/some people xerox a paper/papers]
 for each other].’

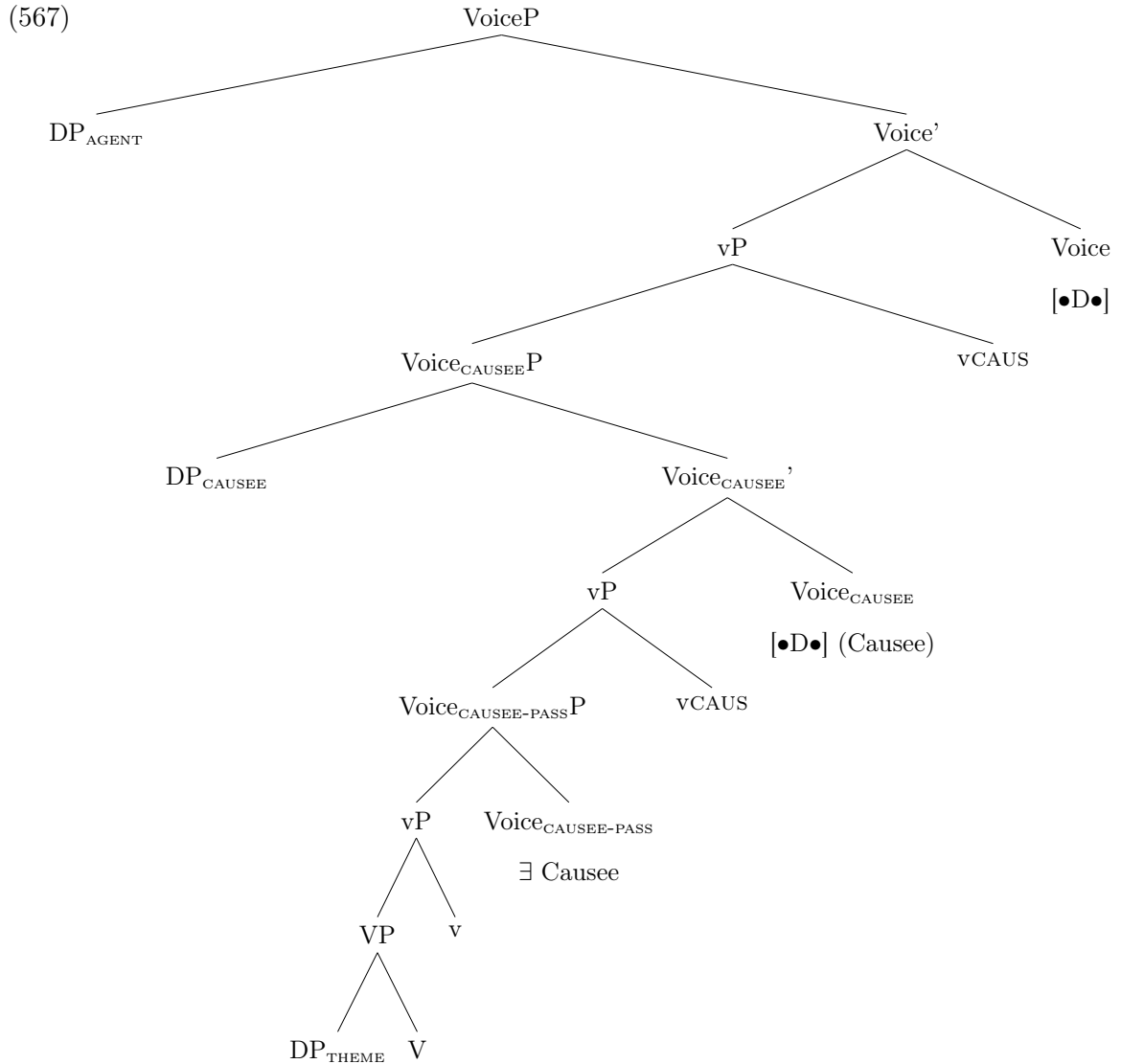

Note that the proposal that the causatives with a null causee are passives raises again the question of why the passive morpheme is not embeddable under causative, as in (568).

- (568) *Adam et-i kes-il-dir-di.
 man meat-ACC cut-PASS-CAUS-PST
 'The man had the meat be cut.'

I attribute this to the VI specification of the embedded Voice head. $\text{Voice}_{\text{CAUSEE}}$ head differs from the canonical Voice in that VI realizing the former terminal node has no morphological exponence. I implement this as follows. The VIs in (569) indicate that the applicative Voice has zero exponence. On the other hand, a canonical Voice head is realized as $-(I)n$,

after stems that end in [l], or stems that end in vowels. With other stems, passive Voice is realized as $-(I)l$.

- (569) a. $\text{Voice}_{\text{CAUSEE-PASS}} \leftrightarrow -\emptyset$
 b. $\text{Voice}_{\text{PASS}} \leftrightarrow -(I)n / \{l\#, V\#\} _$
 c. $\text{Voice}_{\text{PASS}} \leftrightarrow -(I)l / \text{Elsewhere}$

Recall that ‘by’-phrases are also ruled out in Turkish causatives, as shown in (570).

- (570) *Adam et-i kasap tarafından kes-tir-di.
 man meat-ACC butcher by cut-CAUS-PST
 ‘The man had the meat be cut by the butcher.’

Two possible solutions seem plausible. The first one is on the basis of analogy with Sason Arabic (SA). As discussed in Chapter 3, ‘by’-phrases in geminate causatives and ‘give’-causatives in SA are introduced with a different preposition, i.e. ‘to, for’ and not the preposition ‘by’, which is used in canonical passives. It could just be that Turkish lacks this alternative ‘by’-phrase to introduce the Causee. However, as we have seen, the Turkish Causee resembles the Causee of ‘make’-causatives in SA more in terms of its behavior. Thus, I do not consider this as the likely explanation. The second possibility relies more on the semantics of the $\text{Voice}_{\text{CAUSEE}}$ head. As has been mentioned earlier, passive is standardly taken to have two semantic denotations: allowing the external θ -role to be satisfied by the ‘by’-phrase, when present, and to otherwise be interpreted existentially. It could be that in Turkish causatives, $\text{Voice}_{\text{CAUSEE}}$ only has the second option, in which the Causee is existentially bound on the $\text{Voice}_{\text{CAUSEE-PASS}}$ head. On the other hand, it lacks the second semantic denotation, in which $\text{Voice}_{\text{CAUSEE-PASS}}$ would leave the Causee position open, i.e. $\lambda e. \lambda x. \text{CAUSEE}(x, e)$, to be accessed by the ‘by’-phrase. If we choose the second path, we end up with the typology in Table 4.1 for passive denotations:

Table 4.1 shows that whereas canonical passives allow both denotations of passives, ‘make’-causatives in Sason Arabic and Icelandic ‘caused experiencers’ (Ingason 2016), and causatives in Turkish allow only one of these denotations. Presumably, a language lacking both of these denotations would lack passives altogether.

	Passive	
	\exists	'by'-phrase
canonical	✓	✓
'make' causatives in SA Icelandic 'caused experiencer'	*	✓
Turkish causatives	✓	*

Table 4.1: Passive typology

In the next section, I investigate a connection between the availability of the existential interpretation and transitivity.

4.5 Existential interpretation and transitivity

Under what conditions an existential interpretation can be allowed in Turkish causatives is a significant question. Therefore, any analysis of Turkish causatives should preferably incorporate this question into the analysis. One advantage of Key's (2013) and Harley's (2017a) view, i.e., dative Causee as an adjunct, is that the contrast between (571) and (572) appears to straightforwardly follow from this.

(571) Structurally case-marked object

- a. Bütün misafir-ler-e araba-yı temizle-t-ti.
all guest-PL-DAT car-ACC clean-CAUS-PST
'(S/he) made all the guests clean the car.'
- b. Araba-yı temizle-t-ti.
car-ACC clean-CAUS-PST
'(S/he) had the car cleaned.'

(572) Oblique object

- a. Şoför yolcu-lar-ı otobüs-e bin-dir-di.
driver passenger-PL-ACC bus-DAT board-CAUS-PST
'The driver made the passengers board the bus.'
- b. *Şoför otobüs-e bin-dir-di.
driver bus-DAT board-CAUS-PST
'The driver had the bus boarded.' (Özkaragöz 1986:120)

This is because that analysis is built on the (implicit) assumption that since dative Causee is an adjunct, its absence would lead to an existential interpretation. In this way, the *null causee* is to the *overt causee* as the *implicit agent of passive* is to the ‘*by*’-phrase version, schematized in (573).

(573) null causee : overt causee :: implicit agent of passive : ‘by’-phrase

On the other hand, the accusative Causee is an argument, which explains the absence of an existential, indefinite interpretation with it.

Elegant as it might seem, this approach faces several challenges. First, it is not clear how an existential interpretation would be maintained in the absence of a dative Causee since the embedded structure is vP, and not VoiceP.⁴⁷ Secondly, being an argument does not rule out its implicit counterpart from having an indefinite, existential interpretation. For example, in English, an implicit second object of the double object construction can be interpreted as indefinite, and can often license sluicing.

- (574) a. She is going to serve the guests now, but I don’t know what.
 b. She is going to feed the dogs now, but didn’t say what. (Bruening 2020:10a-b)

More importantly, we have seen in Section 4.3 that the overt dative Causee is also an argument, and not an adjunct. Therefore, we need a different analysis that accounts for the configurations in which the existential interpretation is allowed.

Stromdahl and Nematova (2019b) provides another suggestion to capture the existential interpretation. On the basis of Uzbek and Turkish causative constructions, they arrive at the generalizations in (575).

- (575) a. When a verbal predicate that takes an ACC marked internal argument is causativized, its external argument can receive an existential interpretation.
 b. When a verbal predicate that does not take an ACC marked internal argument is causativized, its external argument cannot receive an existential interpretation.

⁴⁷The same issue carries over to Nie’s (2020) system with non-active Voice, which is not predicted to have existential interpretation.

Stromdahl and Nematova’s (2019b) examination focuses on the connection between the possibility of passivization and the existential interpretation of the causee, which they summarize in Table 4.2 and Table 4.3, respectively. Glossing over the details of the paradigms, the basic connection Stromdahl and Nematova (2019b, 9) make is that only verbal predicates that take an ACC marked internal argument can be passivized, and only the Causee of those predicates can have existential interpretation. These predicates contrast with other types of predicates which cannot passivize, and the Causee cannot be interpreted existentially.

	PersPass?	Pass? ⁴⁸
Trans ACC	✓	✓
Trans DAT	*	✓
Unerg	*	✓
Refl	*	✓
Recip	*	✓
Unacc	*	*

Table 4.2: Passivization paradigm

	∃Interp?	Make/Let?
Trans ACC	✓	✓
Trans DAT	*	✓
Unerg	*	✓
Refl	*	✓
Recip	*	✓
Unacc	*	*

Table 4.3: Causativization paradigm

In this section, I argue that the generalization in (575) is incomplete: although (575a) is correct, (575b) is not. In order to give a complete descriptive generalization, I provide the patterns in Table 4.4 (I maintain most of the terms from Stromdahl and Nematova 2019b, though I change DAT to ‘oblique’, and use P-INC to refer to ‘pseudo-incorporation’). The inclusion of predicates with pseudo-incorporated objects and verbs taking finite clauses into

⁴⁸Stromdahl and Nematova (2019b) use the label ‘non-personal passive’, marked with the label *Pass?*, to categorize predicates which disallow ‘by’-phrases. As I argued in Chapter 1, these are actually Impersonals, and not ‘non-personal passive’ or ‘impersonal passives’. The authors also claim that unaccusatives disallow personal or non-personal passivization (‘Impersonal’) altogether. However, the examples they provide have episodic reading, which explains their ungrammaticality. Therefore, I also correct this part in the table I sketch below.

these paradigms in terms of their passivization possibilities, the existential interpretation as well as the case of the Causee calls for a slightly different generalization that makes reference to transitivity, particularly a *domain-specific transitivity*.

	Impersonal	Passive	Causee \exists	Case of Causee
Trans ACC	*	✓	✓	DAT
Trans P-INC	✓	%	✓	DAT
Trans FIN CLAUSE	✓	*	✓	DAT
Trans OBL	✓	%	*	ACC
Unerg	✓	*	*	ACC
Refl	✓	*	*	ACC
Recip	✓	*	*	ACC
Unacc	✓	*	N/A	N/A

Table 4.4: Existential interpretation paradigm

I first examine what case the Causee is marked with when each predicate type is causativized. This is followed by the investigation of which predicates allow existential interpretation for a null causee, i.e. allow for the causee to be null. The examination reveals that there is an overlap between the set of predicates whose Causee is dative-case marked and those which allow the existential reading. However, I suggest a transitivity-based approach, rather than an approach that makes reference to the adjunct/argument status of the Causee or the case of the Causee per se.

4.5.1 Case of the Causee

As briefly mentioned in section 4.1, when a transitive predicate with a structurally case-marked object is causativized, the Causee is marked with dative case.

- (576) a. bütün misafir-ler araba-yı temizle-di-ler.
all guest-PL car-ACC clean-PST-3PL
‘All the guests cleaned the car.’
- b. bütün *misafir-ler-i / misafir-ler-e araba-yı temizle-t-ti.
all *guest-PL-ACC / guest-PL-DAT car-ACC clean-CAUS-PST
‘(S/he) made all the guests clean the car.’

The same patterns holds when the underlyingly transitive verb has a pseudo-incorporated object, as shown in (577), so the causee carries dative case.

- (577) a. bütün misafir-ler araba temizle-di-ler.
 all guest-PL car clean-PST-3PL
 ‘All the guests cleaned car(s).’
- b. bütün *misafir-ler-i / misafir-ler-e araba temizle-t-ti.
 all *guest-PL-ACC / guest-PL-DAT car clean-CAUS-PST
 ‘(S/he) made all the guests clean car(s).’

Moreover, when verbs whose sole internal argument is a (non-case-marked) finite clause are causativized, their Causee also bears Dative case.⁴⁹

- (578) a. Köle-ler hep [kral-ımız çok yaşa] de-r-ler.
 slave-PL always [king-1PL.POSS much live] say-AOR-PL
 ‘The slaves always say may our king live long.’
- b. Film-de gardiyan-lar *köle-ler-i / köle-ler-e hep [kral-ımız
 movie-LOC guardian-PL *slave-PL-ACC / slave-PL-DAT always [king-1PL.POSS

⁴⁹The subjects of certain embedded finite clauses can bear NOM or ACC, which is maintained in causatives, (i).

- (i) Son gelişmeler [sen-(i) topluluğ-un yeni başkan-ı ol-acak-sın diye]
 recent developments [you-(ACC) society-GEN new head-POSS become-FUT-2SG DIYE]
 düşün-dür-(t)-tü biz-e.
 think-CAUS-(CAUS)-PST we-DAT
 ‘Recent developments made us think that you would become the new head of the society.’

However, a (content) noun is allowed with a NOM, but not ACC embedded subject, (ii). This shows that although *diye* clauses are often taken to be adjuncts/modifiers (Yıldırım-Gündoğdu 2017; Özyıldız 2020), they also function as arguments.

- (ii) a. Son gelişmeler [sen-i topluluğ-un yeni başkan-ı ol-acak-sın diye] (*bir şey)
 recent developments [you-ACC society-GEN new head-POSS become-FUT-2SG DIYE] a thing
 düşün-dür-(t)-tü ben-a.
 think-CAUS-(CAUS)-PST I-DAT
 ‘Recent developments made me think that (≈ think a thing like) you would become the new head of the society.’
- b. Son gelişmeler [sen topluluğ-un yeni başkan-ı ol-acak-sın diye] (bir şey)
 recent developments [you society-GEN new head-POSS become-FUT-2SG DIYE] a thing
 düşün-dür-(t)-tü ben-a.
 think-CAUS-(CAUS)-PST I-DAT
 ‘Recent developments made me think that (≈ think a thing like) you would become the new head of the society.’

I leave the investigation of finite clauses aside though since they deserve an in-depth examination.

çok yaşa] de-dirt-ir.
much live] say-CAUS-AOR

‘In the movie, the guardians always make the slaves say may our king live long.’

On the other hand, when an intransitive verb is causativized the Causee bears accusative case. This is exemplified in (579) with the unergative verb ‘to run’.

- (579) a. Sporcu koş-tu.
athlete run-PST
‘The athlete ran.’
- b. Antrenör sporcu-yu / *sporcu-ya koş-tur-du.
trainer athlete-ACC / *athlete-DAT run-CAUS-PST
‘The trainer made the athlete run.’

The same pattern is observed with the limited set of predicates in Turkish that are suffixed with reflexive and reciprocal morphemes.

- (580) reflexive
- a. Ziyaretçi-ler cami-ye giriş-te örtü-n-dü-ler.
visitor-PL mosque-DAT entrance-LOC cover-REFL-PST-PL
‘The visitors covered themselves at the mosque entrance.’
- b. Görevli ziyaretçi-ler-i / *ziyaretçi-ler-e örtü-n-dür-dü.
employee visitor-PL-ACC / *visitor-PL-DAT cover-REFL-CAUS-PST
‘The employee made the visitors cover themselves.’
- c. Belki de korkaklık örtü-n-dür-dü siz-i!
maybe FOC cowardice cover-REFL-CAUS-PST you.pl-ACC
‘Maybe cowardice made you cover yourselves!’⁵⁰

- (581) reciprocal
- a. Küskün dost-lar gör-üş-tü-ler.
sulky friend-PL see-RECP-PST-PL
‘The sulky friends met.’
- b. Büyük-ler küskün dost-lar-ı / *dost-lar-a gör-üş-tür-dü-ler.
old-PL sulky friend-PL-ACC / *friend-PL-DAT cover-REFL-CAUS-PST
‘The elders made the sulky friends meet.’

⁵⁰<http://turuz.com/> Accessed on March 21, 2020.

The sole argument of a causativized unaccusative verb is also marked with accusative, as in (582). However, as shown earlier, the overall structure is mono-eventive, with the behavior of a transitive verb. Therefore, I represent it with N/A (‘non-applicable’) in the relevant tables.

- (582) a. Kalem masa-dan düş-tü.
pencil table-ABL fall-PST
‘The pencil fell from the table.’
- b. Leyla kalem-i / *kalem-e masa-dan düş-ür-dü.
Leyla pencil-ACC / *pencil-DAT table-ABL fall-CAUS-PST
YES: ‘Leyla dropped the pencil from the table.’
NOT: ‘Leyla cause someone to drop the pencil from the table.’

Verbs selecting for an oblique object also pattern like intransitive predicates in that the causee is marked for accusative, and not dative. Consider (583) and (584). The ungrammaticality of (584) also shows that (583) is not ruled out due to the presence of two adjacent dative case-marked arguments.

- (583) a. Yolcu-lar otobüs-e bin-di.
passenger-PL bus-DAT board-PST
‘The passengers boarded the bus.’
- b. Şoför yolcu-lar-ı / *yolcu-lar-a otobüs-e bin-dir-di.
driver passenger-ACC / *passenger-DAT bus-DAT board-CAUS-PST
‘The driver made the passengers board the bus boarded.’
- (584) a. kedi köpek-ten kork-tu.
cat dog-ABL fear-PST
‘The cat feared the dog.’
- b. Çocuk kedi-yi / *kedi-ye köpek-ten kork-ut-tu.
child cat-ACC / *cat-DAT dog-ABL fear-CAUS-PST
‘The child made the cat fear the dog.’ (Çetinoğlu et al. 2008:3)

To summarize, when a transitive predicate with a structurally case marked object, a pseudo-incorporated object or a finite clause is causativized, the Causee bears dative case. With other types of predicates, the Causee is marked with accusative case.

Let us now turn to the investigation of which predicates allow the causee to be null, and result in existential interpretation. However, before proceeding with that discussion, I touch upon an alternative approach Stromdahl and Nematova (2020) provide after they abandon their previous claim about the connection between the existential interpretation of the Causee and the passivization. They instead suggest a ‘verb class explanation’ for it. Leaving aside the details of their analysis, it boils down to suggesting a lexical-verb specific or idiosyncratic feature that determines which verbs allow the existential interpretation. Their claim is based on the observation that the Causee bears DAT even in the context of certain ABL bearing objects (ABLobj), to be illustrated below. I demonstrate that this analysis cannot work since it relies on an incomplete interpretation of the data.

Stromdahl and Nematova (2020) note that in Uzbek, verbs that have external arguments and accusative internal arguments also allow their internal arguments to appear without the accusative case suffix (bareNP), (585), or with the ablative case suffix (ABLobj), (586). They also behave identically in terms of case-alternation on the Causee, in that both trigger dative case on the Causee.⁵¹

(585) BareObj: pour, drink, cut

- a. Lola Fatima-ga choy quy-dir-di.
Lola Fatima-DAT tea pour-CAUS-PST.3.SG
‘Lola had Fatima pour tea.’
- b. *Lola Fatima-ni choy quy-dir-di.
Lola Fatima-ACC tea pour-CAUS-PST.3.SG
‘Lola had Fatima pour tea.’
- c. Lola choy quy-dir-di.
Lola tea pour-CAUS-PST.3.SG
‘Lola had tea poured.’ (Stromdahl and Nematova 2020:23)

⁵¹Stromdahl and Nematova’s (2020) conclusion (glossing over the details or terminology):

- Verb phrases with bare and ablative objects behave like verb phrases with accusative objects. Thus, this favors the Verb class explanation for the transitivity restriction carried by Cause1.
- *Verb class explanation*: Verbal predicates with bare and ablative objects should behave like verbal predicates that take external arguments and accusative objects because both have roots that take arguments and therefore have a transitive little-v.

- (586) ABLObj: pour, drink, cut
- a. Lola Fatima-ga choy-dan quy-dir-di.
 Lola Fatima-DAT tea-ABL pour-CAUS-PST.3.SG
 ‘Lola had Fatima pour some tea.’
- b. *Lola Fatima-ni choy-dan quy-dir-di.
 Lola Fatima-ACC tea-ABL pour-CAUS-PST.3.SG
 ‘Lola had Fatima pour some tea.’
- c. Lola choy-dan quy-dir-di.
 Lola tea-ABL pour-CAUS-PST.3.SG
 ‘Lola had some tea poured.’ (Stromdahl and Nematova 2020:24)

Turkish behaves identically to Uzbek; however the pattern in (586) has a confounding factor. Crucially, “tea-ABL pour” is partitive, and means something like “pour *some/a part/portion of tea* from the tea”, rather than “pour some tea”. In fact, this silent/intended part is the head of this internal argument, and in fact can optionally be overtly realized, and may take ACC case. Consider (587).

- (587) Lola Fatima-ya çay-dan (biraz-ı-nı) dök-tür-dü.
 Lola Fatima-DAT tea-ABL a.little-POSS-ACC pour-CAUS-PST.3SG
 ‘Lola had Fatima pour some of the tea.’

This places such predicates into the category of predicates which select for ACC-marked objects. Thus, it explains why the Causee receives DAT, and not ACC in (586).

We can now move onto the discussion of which predicate types allow for existential interpretation.

4.5.2 Existential interpretation for Causee

When a transitive predicate with an ACC case marked object is causativized, the external argument of the caused event receives DAT case, as mentioned in (588a), repeated from (576). Moreover the role that it bears can be interpreted existentially when it is unpronounced, as in (588b).

- (588) a. bütün misafir-ler-e araba-yı temizle-t-ti.
 all guest-PL-DAT car-ACC clean-CAUS-PST
 ‘(S/he) made all the guests clean the car.’
- b. araba-yı temizle-t-ti.
 car-ACC clean-CAUS-PST
 ‘(S/he) had the car cleaned.’

The causee of verbs taking pseudo-incorporated objects also receive dative case, (589a), and can be left null, yielding an existential interpretation, as in (589b).

- (589) Pseudo-incorporated object
- a. bütün misafir-ler-e araba temizle-t-ti.
 all guest-PL-DAT car clean-CAUS-PST
 ‘(S/he) made all the guests clean car(s).’
- b. araba temizle-t-ti.
 car clean-CAUS-PST
 ‘(S/he) had car(s) cleaned.’

Another example is illustrated in (590), in which some context is also provided.

- (590) [John asks Mary, a music teacher, what she did in the class the day before]
- a. Hiç, öğrenci-ler-e sadece şarkı söyle-t-ti-m.
 nothing student-PL-DAT only song sing-CAUS-PST-1SG
 ‘Not much, I only made the students sing song(s).’
- b. Hiç, sadece şarkı söyle-t-ti-m.
 nothing only song sing-CAUS-PST-1SG
 ‘Not much, I only had song(s) sung.’

Moreover, verbs with a finite clause complement whose Causee receives DAT case, also allow for the Causee to be left implicit and interpreted existentially.

- (591) a. Film-de gardiyan-lar köle-ler-e hep [kral-ımız çok yaşa]
 movie-LOC guardian-PL slave-PL-DAT always [king-1PL.POSS much live]
 de-dirt-ir.
 say-CAUS-AOR
 ‘In the movie, the guardians always make the slaves say may our king live long.’

- b. Film-de gardiyan-lar hep [kral-ımız çok yaşa] de-dirt-ir.
 movie-LOC guardian-PL always [king-1PL.POSS much live] say-CAUS-AOR
 ‘In the movie, the guardians always have [may our king live long] be said.’

On the other hand, verbs taking oblique objects disallow for the Causee to be left unpronounced, and interpreted existentially.

- (592) a. Şoför yolcu-lar-ı otobüs-e bin-dir-di.
 driver passenger-PL-ACC bus-DAT board-CAUS-PST
 ‘The driver made the passengers board the bus.’
 b. *Şoför otobüs-e bin-dir-di.
 driver bus-DAT board-CAUS-PST
 ‘The driver had the bus boarded.’ (Özkaragöz 1986:120)

Note that even some context does not make possible the existential interpretation.⁵²

- (593) [John asks Mary, a swimming teacher, what she did in the class the day before]
 a. Hiç, öğrenci-ler-i takla-ya alış-tır-dı-m.
 nothing student-PL-ACC kick-DAT get.used.to-CAUS-PST-1SG
 ‘Not much, I only made the students get used to the kicks (in water).’
 b. *Hiç, takla-ya alış-tır-dı-m.
 nothing kick-DAT get.used.to-CAUS-PST-1SG
 ‘Not much, I only made someone/some people get used to the kicks (in water).’

Reflexives and reciprocals exhibit the same pattern.

- (594) Reflexive
 a. Görevli ziyaretçi-ler-i örtü-n-dür-dü.
 employee visitor-PL-ACC cover-REFL-CAUS-PST
 ‘The employee made the visitors cover themselves.’
 b. *Görevli örtü-n-dür-dü.
 employee cover-REFL-CAUS-PST
 ‘The employee made someone/some people cover themselves.’

- (595) [John asks Mary, a couples therapist, what she did in the therapy the day before]

⁵²I crucially avoid contexts in which the Causee is introduced as a discourse topic, to which the dropped Causee would co-refer, since this would be an instance of *pro*-drop.

- a. Hiç, çift-ler-i öp-üş-tür-dü-m.
 nothing couple-PL-ACC kiss-RECP-CAUS-PST-1SG
 ‘Not much, I only made couples kiss each other.’
- b. *Hiç, öp-üş-tür-dü-m.
 nothing kiss-RECP-CAUS-PST-1SG
 ‘Not much, I only made some people kiss each other.’

The causee of a causativized unergative verb, which also receives ACC case, cannot be interpreted existentially.

- (596) a. Antrenör sporcu-yu koş-tur-du.
 trainer athlete-ACC run-CAUS-PST
 ‘The trainer made the athlete run.’
- b. *Antrenör koş-tur-du.
 trainer run-CAUS-PST
 ‘The trainer caused to run.’ (Özkaragöz 1986:120)

Another example is illustrated in (590).

- (597) [John asks Mary, a swimming teacher, what she did in the class the day before]
- a. Hiç, öğrenci-ler-i sadece kısa mesafe yüz-dür-dü-m.
 nothing student-PL-ACC only short distance swim-CAUS-PST-1SG
 ‘Not much, I only made the students swim short distance.’
- b. *Hiç, sadece kısa mesafe yüz-dür-dü-m.
 nothing only short distance swim-CAUS-PST-1SG
 ‘Not much, I only made someone/some people swim short distance.’

Looking at the patterns summarized in Table 4.5, it is relatively straightforward to connect the possibility of existential reading to the case of the Causee. Predicates whose causee receives DAT permit the causee to be unpronounced, and interpreted existentially, whereas a causee bearing ACC case may not be. However, I have not been able to find independent evidence in the language (or crosslinguistically) that ties existential reading to the case an argument carries.

This pattern is reminiscent of the connection usually drawn between ergativity and transitivity, in the sense that what counts as transitive for the assignment of ergative case

	Impersonal	Passive	Causee \exists	Case of Causee
Trans ACC	*	✓	✓	DAT
Trans P-INC	✓	%	✓	DAT
Trans FIN CLAUSE	✓	*	✓	DAT
Trans OBL	✓	%	*	ACC
Unerg	✓	*	*	ACC
Refl	✓	*	*	ACC
Recip	✓	*	*	ACC
Unacc	✓	*	N/A	N/A

Table 4.5: Predicate types and interpretation of Causee

can vary significantly from language to language (e.g. Legate 2017; Woolford 2015; Baker 2014; Akkuş 2020b).

This is the point I capitalize on in order to capture the configurations in which existential interpretation is possible. I connect the existential interpretation to ‘transitivity’. In this regard, it is not about the Case of the Causee, or passivization per se. Instead, it is about what counts as ‘transitive’, particularly a *domain-specific transitivity*. The background assumption (that we have motivated in this chapter) is that causatives with an overt causee are active, and those with a null causee are passives (also see Zimmer 1976 for a similar idea). In light of this background, recall from Chapter 1 that root-transitive clauses, for standard Turkish speakers, a lower accusative-case marked object is needed for demotion of the higher agent (i.e. existential interpretation) (Öztürk 2005; Özsoy 2009; Legate et al. 2020) along with some other, more flexible varieties which allow the demotion of the external arguments in a larger set of configurations. Given this backdrop, we are compelled then to conclude that for the causatives, not just accusative objects, but also pseudo-incorporated and finite clauses also make the demotion of the Causee possible. On the other hand, we lack the necessary structural configuration with e.g., oblique objects or unergatives. This means that the existential interpretation is not about the Case of the Causee/Agent, but the presence of a lower argument (NP/DP/CP) and its properties.

Note that similar to ergativity and transitivity connection, or the transitivity in root clauses of NOM-ACC languages, we expect to find Turkic or other languages that might

have a different cut-off as to what counts as transitive in causative configurations. I leave the research of this typological prediction to future work.

This section has provided an alternative explanation for when the Causee can be interpreted existentially in Turkish, which does not rely on the adjunct status of it. Instead, I have connected it to a domain-particular transitivity, which is likely to show crosslinguistic or intra-language variation.

4.6 Chapter summary

In this chapter I have investigated Turkish causatives and addressed several issues, with a particular focus on the size of the embedded structure and the status of the Causee in that structure.

First, I have demonstrated that Turkish causatives are bi-eventive, and do embed a thematic, active layer above the embedded *v* (*pace* Key 2013; Harley 2017a; Nie 2020), which I have labelled as $\text{Voice}_{\text{CAUSEE}}\text{P}$. Furthermore, I have presented various diagnostics that converge on the view that the Causee is an argument introduced in $\text{Spec},\text{Voice}_{\text{CAUSEE}}\text{P}$, rather than as an adjunct to CausP (Key 2013; Harley 2017a) or $\text{Voice}_{[-\text{ACT}]}\text{P}$ (Nie 2020).

Once the size and the category of the embedded constituent as well as the status of the Causee are established, I argued that Turkish causatives manifest an active-passive alternation despite the absence of any morphological exponence or ‘by’-phrases. As such, the null causee is not syntactically projected, but is existentially closed on the $\text{Voice}_{\text{CAUSEE-PASS}}$ head.

Moreover, I have contended that whether a Causee can be left unpronounced and interpreted existentially depends on ‘transitivity’, i.e. what counts as a transitive to allow the demotion of the external argument. The transitivity configuration crucially differs between root clauses and causatives in Turkish.

Chapter 5

Conclusion

In this dissertation, I have explored the relationship between Voice, (implicit) argument introduction and (Case-) licensing, with a focus on Sason Arabic (SA) and Turkish. Building on the recent research on Voice (e.g., Pylkkänen 2002, 2008; Schäfer 2008; Harley 2013; Legate 2014), I have aimed to provide a better understanding of the syntax of different types of Voice and related constructions, including passives, impersonals, causatives and applicatives. My investigation reveals the need for different ‘flavors’ of Voice as well as distinct implicit arguments.

The dissertation contributes to the discussion and ontology of ‘implicit arguments’, addressing several questions as to their syntactic and semantic visibility. The investigation further corroborates the view that implicit arguments form a heterogeneous category and may manifest distinct behavior from one another (cf. Bhatt and Pancheva 2006, 2017; Landau 2010; Bruening 2020). The examination reveals that a single language can have multiple types of implicit arguments, and focuses on (at least) four types of implicit arguments in the languages in question: (i) an impersonal pronoun, (ii) an existentially closed passive agent, (iii) a free variable on thematic, active Voice, and (iv) a fully projected DP, which is subject to a licensing requirement.

In Chapter 2, I have examined the properties of null and overt impersonals in Turkish, focusing on various constructions. The investigation of the so-called ‘passives of passives’ in Turkish reveals that they are in fact ‘impersonals of passives’. I have demonstrated the existence of two distinct constructions with identical morphology: (i) a *passive*, which is limited in application to transitive predicates with a thematic subject and structurally case

marked object, and (ii) an *impersonal*, with an unpronounced impersonal pronoun filling the argument position, be it the thematic subject or the thematic object. This finding provides support to the original claim by Perlmutter and Postal (1977, et seq) that passive verbs cannot undergo passivization. Following Legate 2014, I analyze passive as a variant of a functional head that introduces a DP in its specifier. On the other hand, in the impersonal construction, the functional head Impers⁰ licenses the impersonal pronoun, which I implement via the Agree operation.

The chapter also deals with the status of the null element found in Negation-Licensed Commands (NLCs), which are essentially nominalizations that become commands in the presence of negation, such as *No playing soccer inside the house!*. Focusing on NLCs from Turkish, SA and English, I argue that in NLCs as well, an unpronounced impersonal pronoun in the form of PROARB can fill the argument position, (*pace* Pak et al. 2020, who suggest that NLCs do not syntactically project the subject).

In the final section of the chapter, I have compared the null impersonal with the overt impersonal *insan* ‘human’ in Turkish in terms of various syntactic and semantic diagnostics. These include syntactic positions, case, interpretational restrictions. Recent syntactic analyses (Egerland 2003, Fenger 2018, Ackema and Neeleman 2018, i.a.) classify impersonals into two types, one with more functional structure; and one with less. Within this bifurcation, the null impersonal in Turkish patterns with the latter type that contains less functional structure. The overt impersonal, *insan* ‘human’, on the other hand, with the former type, with more functional structure. Despite this bifurcation, I also note the null impersonal does not neatly fall into the split Fenger (2018) makes.

In Chapter 3, I investigate various causative constructions in Sason Arabic. SA has several morphological and peripheral causative strategies, namely ablaut and gemination, as well as causatives embedded under the verbs ‘give’ and ‘make’ (the extent to which they are available seems to vary across villages/speakers).

Starting with the ‘make’-causatives, I have argued that ‘make’ embeds a reduced structure: no AspP or higher projections (i.e. a restructuring configuration). I have demon-

strated that ‘make’-causatives can embed three structures: it embeds a passive VoiceP with an obligatory ‘by’-phrase, or an FP dominating an active VoiceP.

(598) passive VoiceP

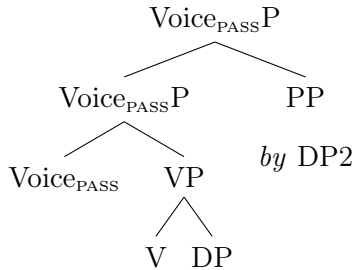

active VoiceP

(variable agent)

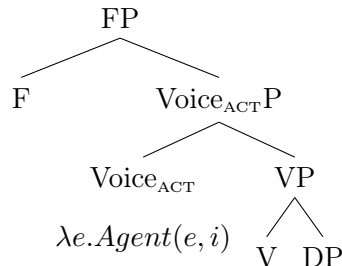

active VoiceP

(full DP agent)

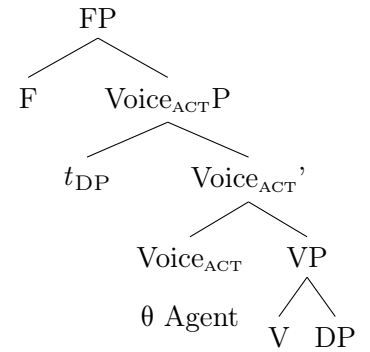

The embedded agent can be introduced in two ways in the active VoiceP: (i) as a ‘free variable’ on the Voice head, which adds to the typology of implicit arguments. This possibility also indicates that (Case-) licensing of the object is dissociated from the thematic subject. (ii) as a full DP, which is subject to a licensing restriction. The embedded agent needs to be \bar{A} -moved to be in the same local domain as its licenser. As such, this construction is part of a larger crosslinguistic pattern, in which certain positions cannot be occupied with overt elements.

The chapter also discusses causatives expressed via gemination and causatives embedded under the verb ‘give’. I have argued that these causatives provide independent support to the analysis of passive in this dissertation (following Legate 2014), which treats passive a variant of a functional head that introduces a DP in its specifier. I have demonstrated that these two causative strategies do embed a second VoiceP, however this VoiceP exhibits distinct behavior from the canonical, agentive VoiceP, which warrants identifying it as a distinct category. I have labelled this category as CauseeP. In line with the analysis of passives in this dissertation, I have shown that geminates manifest an active-passive alternation, whereas the ‘give’ causatives embed only a passive CauseeP. Therefore, the null argument in these constructions is an implicit ‘agent’ of passives.

In Chapter 4, I have investigated the properties of the morphological productive causatives in Turkish from several different perspectives, which connect to the main thread of the dissertation. I focused on two recent arguments made about Turkish causatives, i.e., the structural properties of the embedded constituent and the status of the overt causee versus null causee. Recently it has been claimed that Turkish causatives embed only a vP and no higher projections (Key 2013; Harley 2017a), or only a non-active Voice (Nie 2020), which are identical in terms of the relevant features. Secondly, these studies have argued that the (dative) Causee is an adjunct, and not an argument. Revisiting some of the diagnostics and providing new tests, I have argued that neither of the claims about Turkish causatives is tenable. Turkish causatives embed a type/ flavor of thematic Voice, which I called Voice_{CAUSEE}P, and the Causee is generated as an argument in Spec, Voice_{CAUSEE}P, and not an adjunct. This chapter highlights the importance of exhausting language-internal properties of a particular language as much as drawing conclusions based mainly on crosslinguistic comparisons. On the other hand, the null causee is not syntactically projected, but is existentially interpreted in passive Voice_{CAUSEE}.

In the second part of the chapter, I have addressed the question of which predicates allow the causee to be left unpronounced, and be interpreted existentially. After introducing a more complete empirical picture, I have argued that the existential interpretation of the Causee relates to a domain-specific transitivity, and not passivization or the case of the causee *per se*. Crucially, the domain of transitivity in causatives is distinct from that of root clauses. Putting various passive constructions from the dissertation together, I have shown that a potential prediction of adopting two semantic denotations for passive is also borne out. I have demonstrated that inter- or intra-language variation is possible in terms of which denotation(s) of passive they manifest. Some constructions allow both denotations of passive, whereas some others allow only one of the denotations: either the one with existential closure or the one with a ‘by’-phrase.

Bibliography

- Abels, K. (2012). *Phases: An essay on cyclicity in syntax*. Walter de Gruyter.
- Abramovitz, R. (2020). Successive-Cyclic *Wh*-movement Feeds Case Competition in Koryak. Ms., MIT.
- Ackema, P. and Neeleman, A. (2013). Person features and syncretism. *Natural Language & Linguistic Theory*, 31(4):901–950.
- Ackema, P. and Neeleman, A. (2018). *A grammar of person*. MIT Press, Cambridge, MA.
- Adger, D. (2003). *Core Syntax*. Oxford University Press, Oxford.
- Aissen, J. and Hankamer, J. (1980). Lexical extension and grammatical transformations. In *Proceedings of the Sixth Annual Meeting of the Berkeley Linguistics Society*, pages 238–249.
- Akkuş, F. (2015). The Syntax of (Complex) Tense in Sason Arabic. In *Handout at the 29th Annual symposium on Arabic Linguistics (ASAL29)*.
- Akkuş, F. (2016). The Arabic Dialect of Mutki-Sason Areas. In *Arabic Varieties: Far and Wide. Proceedings of the 11th Conference of AIDA*, pages 29–41. Editura Universităţii din Bucureşti.
- Akkuş, F. (2017). Peripheral Arabic Dialects. In Benmamoun, E. and Bassiouney, R., editors, *The Routledge Handbook of Arabic Linguistics*, pages 454–471. Routledge.
- Akkuş, F. (2020a). Anatolian Arabic. In Lucas, C. and Manfredi, S., editors, *Arabic and contact-induced change: A handbook*, pages 135–158. Berlin: Language Science Press.

- Akkuş, F. (2020b). On Iranian Case and Agreement. *Natural Language & Linguistic Theory*, 38(3):671–727.
- Akkuş, F. and Benmamoun, E. (2018). Syntactic outcomes of contact in Sason Arabic. In Manfredi, S., Tosco, M., and Banti, G., editors, *Arabic in Contact*, volume 6, pages 37–52. John Benjamins.
- Alexiadou, A. (2018). -Able adjectives and the syntax of psych verbs. *Glossa: a journal of general linguistics*, 3(1).
- Alexiadou, A. and Anagnostopoulou, E. (1998). Parametrizing AGR: Word order, V-movement, and EPP-checking. *Natural Language & Linguistic Theory*, 16:491–540.
- Alexiadou, A. and Anagnostopoulou, E. (2004). Voice morphology in the causative-inchoative Alternation: evidence for a non unified structural analysis of unaccusatives. In Alexiadou, A., Anagnostopoulou, E., and Everaert, M., editors, *The Unaccusativity Puzzle: Explorations of the Syntax-Lexicon Interface*, pages 115—136. Oxford University Press.
- Alexiadou, A., Anagnostopoulou, E., and Schäfer, F. (2006). The properties of anticausatives crosslinguistically. In Frascarelli, M., editor, *Phases of interpretation*, volume 91, pages 187–211. Mouton de Gruyter.
- Alexiadou, A., Anagnostopoulou, E., and Schäfer, F. (2015). *External arguments in transitivity alternations: A layering approach*. Oxford University Press, Oxford.
- Alrashed, M. A. (2012). *Argument Structure in Arabic: Lexicon or Syntax?* PhD thesis, Arizona State University.
- Anagnostopoulou, E. (2003). *The Syntax of Ditransitives: Evidence from Clitics*. Mouton de Gruyter, Berlin/New York.
- Aoun, J. E., Benmamoun, E., and Choueiri, L. (2010). *The syntax of Arabic*. Cambridge University Press.

- Arad, M. (2003). Locality constraints on the interpretation of roots: The case of Hebrew denominal verbs. *Natural Language & Linguistic Theory*, 21(4):737–778.
- Arad, M. (2005). *Roots and patterns: Hebrew morpho-syntax*. Dordrecht: Springer.
- Arslan, C. (1999). Approaches to *wh*-structures in Turkish. Master’s thesis, Boğaziçi University.
- Arslan-Kechriotis, C. (2006). *Case as an uninterpretable feature*. PhD thesis, Bogaziçi University.
- Atlamaz, Ü. (2012). Ergative as accusative case: evidence from Adıyaman Kurmanji. Master’s thesis, Bogaziçi University. Istanbul.
- Aydın, O. and Kuribayashi, Y. (2008). Covert causee structures in Turkish. In Ay, S., Özgür Aydın, Ergenç, I., Gökmen, S., İşsever, S., and Peçenek, D., editors, *Essays on Turkish Linguistics: Proceedings of the 14th International Conference on Turkish Linguistics*, pages 53—63. Wiesbaden.
- Bach, E. W. (1980). In defense of passive. *Linguistics and Philosophy*, 3:297–341.
- Baker, M. (1985). The mirror principle and morphosyntactic explanation. *Linguistic Inquiry*, 16:373–415.
- Baker, M. (1988). *Incorporation: a theory of grammatical function changing*. University of Chicago Press, Chicago.
- Baker, M. (2014). On dependent ergative case (in shipibo) and its derivation by phase. *Linguistic Inquiry*, 45(3):341—379.
- Baker, M., Johnson, K., and Roberts, I. (1989). Passive arguments raised. *Linguistic Inquiry*, 20:219–251.
- Beck, S. and Johnson, K. (2004). Double objects again. *Linguistic Inquiry*, 35:97–123.

- Benmamoun, E. (1991). Causatives in Moroccan Arabic. *Perspectives in Arabic Linguistics III*, pages 173–195.
- Benmamoun, E. (2000). *The feature structure of functional categories: A comparative study of Arabic dialects*. Oxford University Press.
- Bhatt, R. and Embick, D. (2017). Causative derivations in Hindi-Urdu. *Journal of Indian Linguistics*, 78:1-2:93–151.
- Bhatt, R. and Pancheva, R. (2006). Implicit Arguments. In Everaert, M. and van Riemsdijk, H., editors, *The Blackwell Companion to Syntax*, pages 558—588. Blackwell.
- Bhatt, R. and Pancheva, R. (2017). Implicit Arguments. In Everaert, M. and van Riemsdijk, H., editors, *The Wiley Blackwell Companion to Syntax*. Blackwell.
- Biggs, A. and Embick, D. (2020). On the event structural properties of the English get-passive. *Linguistic Inquiry*.
- Biktimir, T. (1986). Impersonal passives and the *-arak* construction in Turkish. In Slobin, D. I. and Zimmer, K., editors, *Studies in Turkish linguistics*, pages 53–75. Benjamins, Amsterdam/Philadelphia.
- Blevins, J. P. (2003). Passives and impersonals. *Journal of Linguistics*, 39(3):472–520.
- Boneh, N. and Sichel, I. (2010). Deconstructing possession. *Natural Language & Linguistic Theory*, 28(1):1–40.
- Bošković, Ž. (1997). *The syntax of nonfinite complementation: An economy approach*. MIT Press.
- Bošković, Ž. (2002). A-movement and the epp. *Syntax*, 5(3):167–218.
- Bošković, Ž. (2014). Now I’m a phase, now I’m not a phase: On the variability of phases with extraction and ellipsis. *Linguistic Inquiry*, 45(1):27–89.
- Bowers, J. (2010). *Arguments as relations*. MIT Press, Cambridge, MA.

- Bresnan, J. (2001). *Lexical-functional syntax*. Blackwell, Oxford.
- Bruening, B. (2001). *Syntax at the edge: Cross-clausal phenomena and the syntax of Pas-samaquoddy*. PhD thesis, MIT.
- Bruening, B. (2010). Ditransitive asymmetries and a theory of idiom formation. *Linguistic Inquiry*, 41:519–562.
- Bruening, B. (2013). By-phrases in passives and nominals. *Syntax*, 16:1–41.
- Bruening, B. (2020). Implicit arguments in english double object constructions. *Natural Language & Linguistic Theory*, pages 1–63.
- Burzio, L. (1986). *Italian syntax: A government-binding approach*. Reidel.
- Camilleri, M., ElSadek, S., and Sadler, L. (2014). A cross dialectal view of the arabic dative alternation. *Acta Linguistica Hungarica*, 61(1):3–44.
- Carlson, G. (2006). The meaningful bounds of incorporation. In Vogeleer, S. and Tasmowski, L., editors, *Non-Definiteness and Plurality*, pages 35–50. John Benjamins.
- Çakır, S. (2016). Island Constraints, and Adjunct and Argument Asymmetry in Turkish. *Dilbilim Araştırmaları Dergisi*, pages 1–15.
- Çakır, S. (2020). Long distance scrambling and operator movement in Turkish. *Journal of Language and Linguistic Studies*, pages 440–457.
- Çetinoğlu, Ö., Butt, M., and Oflazer, K. (2008). Mono/bi-clausality of Turkish Causatives. In Ay, S., Özgür Aydın, Ergenç, I., Gökmen, S., İşsever, S., and Peçenek, D., editors, *Essays on Turkish Linguistics: Proceedings of the 14th International Conference on Turkish Linguistics*, pages 43–53. Wiesbaden.
- Chierchia, G. (1995a). *Dynamics of Meaning*. University of Chicago Press, Chicago.

- Chierchia, G. (1995b). The variability of impersonal subjects. In Bach, E., Jelinek, E., Kratzer, A., and Partee, B., editors, *Quantification in Natural Languages*, pages 107–143. Kluwer, Dordrecht.
- Chomsky, N. (1965). *Aspects of the Theory of Syntax*. MIT Press, Cambridge, MA.
- Chomsky, N. (1986). *Knowledge of Language: Its Nature, Origin, and Use*. Praeger, New York.
- Chomsky, N. (1995a). Bare phrase structure. In Webelhuth, G., editor, *Government and Binding theory and the Minimalist Program*, pages 383–439. Blackwell, Cambridge, MA.
- Chomsky, N. (1995b). *The Minimalist Program*. MIT Press, Cambridge, MA.
- Chomsky, N. (2000). Minimalist inquiries. In Martin, R., Michaels, D., and Uriagereka, J., editors, *Step by Step: Essays on Minimalism in Honor of Howard Lasnik*, pages 89–155. MIT Press, Cambridge, MA.
- Chomsky, N. (2001). Derivation by phase. In Kenstowicz, M., editor, *Ken Hale: a life in language*, pages 1–52. MIT Press.
- Chomsky, N. and Lasnik, H. (1993). The theory of principles and parameters. In Jacobs, J., von Stechow, A., Sternefeld, W., and Vennemann, T., editors, *Syntax: An international handbook of contemporary research*, pages 506–569. Walter de Gruyter, Berlin.
- Cinque, G. (1988). On *si* constructions and the theory of *arb*. *Linguistic Inquiry*, 19:521–581.
- Clem, E. (2019). Amahuaca ergative as agreement with multiple heads. *Natural Language & Linguistic Theory*, 37(3):785–823.
- Collins, C. (2005). A smuggling approach to the passive in English. *Syntax*, 8(2):81–120.
- Collins, C. (2018a). On the phi-features of the implicit argument in the passive. manuscript.
- Collins, C. (2018b). The theta-criterion, utah and the projection of external arguments in the passive. manuscript.

- Comrie, B. (1977). In defense of spontaneous demotion: The impersonal passive. In Cole, P. and Sadock, J. M., editors, *Grammatical Relations*, pages 47–58. Academic Press, New York.
- Culicover, P. W. and Jackendoff, R. (2005). *Simpler syntax*. Oxford University Press, Oxford.
- D’Alessandro, R. (2007). *Impersonal si Constructions*. Mouton de Gruyter, Berlin.
- de Swart, H. (1993). *Adverbs of Quantification: A Generalized Quantifier Approach*. Garland, New York.
- Deal, A. R. (2016). Cyclicity and connectivity in nez perce relative clauses. *Linguistic Inquiry*, 47(3):427–470.
- Deo, A. (2015). The semantic and pragmatic underpinnings of grammaticalization paths: The progressive to imperfective shift. *Semantics and Pragmatics*, 8(14):1–52.
- Diesing, M. (1992). *Indefinites*. MIT Press, Cambridge, MA.
- Dikken, M. d. (2009). On the nature and distribution of successive cyclicity. *Manuscript, CUNY Graduate Center*.
- Dobrovie-Sorin, C. (1998). Impersonal *se* constructions in Romance and the passivization of unergatives. *Linguistic Inquiry*, 29:399–437.
- Egerland, V. (2003). Impersonal pronouns in Scandinavian and Romance. *Working papers in Scandinavian syntax*, 71:75–102.
- Embick, D. (2004). On the structure of resultative participles in English. *Linguistic Inquiry*, 35:355–392.
- Erdem, M. (2000). Historical development of passives in Turkish. In Özsoy et al., S., editor, *Studies in Turkish Linguistics*, pages 37–48. Boğaziçi University Press.

- Erguvanlı-Taylan, E. (1986). Pronominal versus zero representation of anaphora in Turkish. In Slobin, D. and Zimmer, K., editors, *Studies in Turkish linguistics*, pages 209–231. John Benjamins, Amsterdam.
- Erguvanlı-Taylan, E. (2017). Language Contact in Anatolia: the case of Sason Arabic. In Korkmaz, R. and Gürkan, D., editors, *Endangered Languages of the Caucasus and Beyond*, pages 209–225. Brill.
- Ernst, T. (2001). *The syntax of adjuncts*, volume 96. Cambridge University Press.
- Ernst, T. (2020). The Syntax of Adverbials. *Annual Review of Linguistics*, 6(1):89–109.
- Fassi Fehri, A. (1987). Anti-causatives in Arabic, causativity and affectedness. *Manuscript, Cambridge: Mass.*
- Fenger, P. (2018). How impersonal does *one* get? A study of *man*-pronouns in Germanic. *The Journal of Comparative Germanic Linguistics*, 21(3):291–325.
- Fillmore, C. (1968). The case for Case. In Bach, E. and Harms, R., editors, *Universals in linguistic theory*. Holt, Rinehart and Winston.
- Folli, R. and Harley, H. (2006). Benefactives aren't Goals in Italian. In Doetjes, J. and González, P., editors, *Romance Languages and Linguistic Theory*, pages 121–142. Amsterdam/Philadelphia: John Benjamins.
- Folli, R. and Harley, H. (2007). Causation, obligation, and argument structure: On the nature of little *v*. *Linguistic Inquiry*, 38(2):197–238.
- Georgala, E. (2011). *Applicatives in their Structural and Thematic Function*. PhD thesis, Cornell University.
- George, L. and Kornfilt, J. (1977). Infinitival Double Passives in Turkish. In Kegel, J., Nash, D., and Zaenen, A., editors, *Proceedings of the seventh annual meeting of the North Eastern Linguistic Society*, pages 65–79.

- Georgi, D. and Salzmänn, M. (2017). The matching effect in resumption: A local analysis based on case attraction and top-down derivation. *Natural Language & Linguistic Theory*, 35(1):61–98.
- Göksel, A. (1993). *Levels of representation and argument structure in Turkish*. PhD thesis, SOAS.
- Göksel, A. and Kerslake, C. (2005). *Turkish: A comprehensive grammar*. Routledge.
- Görgülü, E. (2006). Variable wh-words in Turkish. Master’s thesis, Boğaziçi University.
- Gračanin-Yüksek, M. and İşsever, S. (2011). Movement of bare objects in turkish. *Dilbilim Araştırmaları*, 22(1):33–49.
- Gribanova, V. (2013). Copular clauses, clefts, and putative sluicing in uzbek. *Language*, pages 830–882.
- Groefsema, M. (1995). Understood arguments: A semantic/pragmatic approach. *Lingua*, 96(2-3):139–161.
- Guasti, M. T. (1996). Semantic restrictions in Romance causatives and the incorporation approach. *Linguistic Inquiry*, pages 294–313.
- Hale, K. and Keyser, S. J. (1993). On argument structure and the lexical expression of syntactic relations. In Hale, K. and Keyser, S. J., editors, *The view from Building 20: Essays in honor of Sylvain Bromberger*, pages 53–109. MIT Press, Cambridge.
- Hall, A. M. (2009). *Free pragmatic processes and explicit utterance content*. PhD thesis, University of London.
- Halle, M. and Marantz, A. (1993). Distributed morphology and the pieces of inflection. In Hale, K. and Keyser, S. J., editors, *The view from Building 20: Essays in honor of Sylvain Bromberger*, pages 111–176. MIT Press, Cambridge.
- Hallman, P. (2006). Causativity and Transitivity in Arabic. *Manuscript, University of Toronto*.

- Harley, H. (1995). *Subjects, events and licensing*. PhD thesis, MIT.
- Harley, H. (2008). On the causative construction. In Miyagawa, S. and Saito, M., editors, *Handbook of Japanese Linguistics*, pages 20–53. Oxford University Press, Oxford.
- Harley, H. (2013). External arguments and the Mirror Principle: On the distinctness of Voice and v. *Lingua*, 125:34–57.
- Harley, H. (2017a). The “bundling” hypothesis and the disparate functions of little v. In d’Alessandro, R., Franco, I., and Gallego, A., editors, *The verbal domain*, pages 3–28. Oxford University Press, Oxford.
- Harley, H. (2017b). ‘Passive’ as agreement: Suppressing subjects in Hiaki. University of Arizona, manuscript.
- Harley, H. and Stone, M. S. (2013). The ‘No Agent Idioms’ hypothesis. In Folli, R., Sevdali, C., and Truswell, R., editors, *Syntax and its limits*, pages 191–222. Oxford University Press.
- Heim, I. (1982). *The semantics of definite and indefinite NPs*. PhD thesis, University of Massachusetts at Amherst.
- Heim, I. and Kratzer, A. (1998). *Semantics in Generative Grammar*. Blackwell Publishing, Oxford.
- Hoekstra, J. (2010). On the impersonal pronoun *men* in West Frisian. *Journal of Comparative Germanic Linguistics*, 13:31–59.
- Holmberg, A. (2005). Is there a little pro? *Linguistic Inquiry*, 36:533–564.
- Holmberg, A. (2010). The null generic subject pronoun in Finnish: a case of incorporation in T. In Biberauer, T., Holmberg, A., Roberts, I., and Sheehan, M., editors, *Parametric variation: null subjects in minimalist theory*, pages 200–230. Cambridge University Press.
- Huang, C.-T. J. (1984). On the distribution and reference of empty pronouns. *Linguistic Inquiry*, 15:531–574.

- Iatridou, S. (accepted). Negation-Licensed Commands. *Linguistic Inquiry*.
- İnce, A. (2006). Pseudo-sluicing in Turkish. In Kazanina, N., Minai, U., Monahan, P., and Taylor, H., editors, *University of Maryland Working Papers in Linguistics 14*, pages 111–126.
- Ingason, A. K. (2016). *Realizing morphemes in the Icelandic noun phrase*. PhD thesis, University of Pennsylvania.
- Ingason, A. K., Nowenstein, I. E., and Sigurðsson, E. F. (2016). The voice-adjunction theory of agentive ‘by’-phrases and the icelandic impersonal passive. In *Working Papers in Scandinavian Syntax*, volume 97, pages 40–56.
- Ippolito, M. (2000). Remarks on the argument structure of causatives. manuscript.
- Ito, Y. (2014). Raising to object in *wager/assure*-class verbs: a pf account of the defective paradigm. *Studia Linguistica*, 68(2):226–244.
- Jackendoff, R. S. (1972). *Semantic interpretation in generative grammar*. MIT Press.
- Jaeggli, O. (1986). Passive. *Linguistic Inquiry*, 17:587–622.
- Jaeggli, O. and Safir, K. J. (1989). The null subject parameter and parametric theory. In Jaeggli, O. and Safir, K. J., editors, *The Null Subject Parameter*, pages 1–44. Kluwer, Dordrecht.
- Jarrah, M. and Abusalim, N. (2020). In favour of the low IP area in the Arabic clause structure: Evidence from the VSO word order in Jordanian Arabic. *Natural Language & Linguistic Theory*.
- Jastrow, O. (1978). *Die mesopotamisch-arabischen qaltu-Dialekte. Band I: Phonologie und Morphologie*, volume 43:4. Wiesbaden.
- Jastrow, O. (2005). Uzbekistan Arabic: A Language Created by Semitic-Iranian-Turkic Linguistic Convergence. In Eva Csato, B. I. and Jahani, C., editors, *Linguistic Convergence*

- and Areal Divergence: Case Studies from Iranian, Semitic and Turkic*, pages 133–139. Routledge.
- Jastrow, O. (2006). Anatolian arabic. In Versteegh, K., editor, *Encyclopedia of Arabic Language and Linguistics*, volume I, pages 86–96. Brill.
- Jelinek, E. (1984). Empty categories, case, and configurationality. *Natural Language & Linguistic Theory*, 2:39–76.
- Kahnemuyipour, A. and Megerdooian, K. (2011). Second-position clitics in the vP phase: The case of the Armenian auxiliary. *Linguistic Inquiry*, 42(1):152–162.
- Kahnemuyipour, A. and Megerdooian, K. (2017). On the positional distribution of an armenian auxiliary: Second-position clisis, focus, and phases. *Syntax*, 20(1):77–97.
- Kaiser, E. and Vihman, V.-A. (2006). Invisible arguments: Effects of demotion in estonian and finnish. In Lyngfelt, B. and Solstad, T., editors, *Demoting the agent: Passive, middle and other voice phenomena*, volume 96, pages 111–142. John Benjamins.
- Kallulli, D. (2007). Rethinking the passive/anticausative distinction. *Linguistic Inquiry*, 38:770–780.
- Kayne, R. (1975). *French Syntax. The Transformational Cycle*. MIT Press, Cambridge, MA.
- Kayne, R. S. (1984). *Connectedness and binary branching*, volume 16. Foris Publications.
- Keenan, E. L. (1980). Passive is phrasal (not sentential or lexical). In Hoekstra, T., van der Hulst, H., and Moortgat, M., editors, *Lexical grammar*, pages 181–214. Foris, Dordrecht.
- Keenan, E. L. (1985). Passive in the world’s languages. In Shopen, T., editor, *Language Typology and Syntactic Description, Volume 1: Clause Structure*, pages 243–281. Cambridge University Press.

- Keenan, E. L. and Timberlake, A. (1985). Predicate formation rules in universal grammar. In *Proceedings of the West Coast Conference on Formal Linguistics*, volume 4, pages 123–138.
- Key, G. (2013). *The morphosyntax of the Turkish causative construction*. PhD thesis, University of Arizona.
- Key, G. (2020). Causative Voice in Turkish: an argument from morphology. manuscript.
- Key, G. (2021). Passive in Turkish: Re-thinking *u*-syncretism. manuscript.
- Kibort, A. (2001). The Polish passive and impersonal in Lexical Mapping Theory. In Butt, M. and Holloway King, T., editors, *Proceedings of the LFG01 Conference, University of Hong Kong*. CSLI Publications.
- Kibort, A. and Maskaliūnienė, N. (2016). *Passive Constructions in Lithuanian: Selected works of Emma Geniušienė*, volume 179. John Benjamins.
- Kiparsky, P. (2013). Towards a null theory of the passive. *Lingua*, 125:7–33.
- Knecht, L. (1986). Lexical causatives in turkish. In Slobin, D. I. and Zimmer, K., editors, *Studies in Turkish Linguistics*, pages 93–123. Benjamins, Amsterdam/Philadelphia.
- Knecht, L. E. (1985). *Subject and Object in Turkish*. PhD thesis, Massachusetts Institute of Technology.
- Koenig, J.-P. and Mauner, G. (2000). A-definites and the discourse status of implicit arguments. *Journal of Semantics*, 16(3):207–236.
- Kornfilt, J. (1977). A note on subject raising in Turkish. *Linguistic Inquiry*, 8(4):736–742.
- Kornfilt, J. (1984). *Case marking, agreement, and empty categories in Turkish*. PhD thesis, Harvard University.

- Kornfilt, J. (1991a). A case for emerging functional heads. In Rothstein, S., editor, *Perspective on Phrase Structure: heads and licensing*, volume 25, pages 11–35. Academic Press.
- Kornfilt, J. (1991b). Some current issues in turkish syntax. In Boeschoten, H. and Verhoeven, L., editors, *Turkish Linguistics Today*, pages 60–92. Brill, New York.
- Kornfilt, J. (1997). *Turkish*. Routledge, London/New York.
- Kornfilt, J. (2001). Local and long-distance reflexives in Turkish. In Cole, P., Hermon, G., and Huang, C.-T. J., editors, *Long-distance reflexives*, pages 197–226. Academic Press, San Diego, CA.
- Kornfilt, J. (2003). Scrambling, subscrambling and case in Turkish. In Karimi, S., editor, *Word order and scrambling*, pages 125–155. Blackwell Publishing, Oxford.
- Kornfilt, J. (2005). Asymmetries between pre-verbal and post-verbal scrambling in Turkish. In Sabel, J. and Saito, M., editors, *The Free Word Order Phenomenon: Its Syntactic and Sources and Diversity*, pages 163–179. De Gruyter Mouton, Berlin/New York.
- Kramer, R. (2014). Clitic doubling or object agreement: The view from amharic. *Natural Language & Linguistic Theory*, 32(2):593–634.
- Kratzer, A. (1996). Severing the external argument from its verb. In Rooryck, J. and Zaring, L., editors, *Phrase Structure and the Lexicon*, pages 109–137. Kluwer, Dordrecht.
- Kratzer, A. (2009). Making a pronoun: Fake indexicals as windows into the properties of pronouns. *Linguistic Inquiry*, 40:187–237.
- Kural, M. (1992). Properties of scrambling in turkish. manuscript.
- Kurylowicz, J. (1957). Esquisse d’une théorie de l’apophonie en Sémitique. *Bulletin de la Société de Linguistique de Paris*, 58:1–38.
- Landau, I. (2004). The scale of finiteness and the calculus of control. *Natural Language & Linguistic Theory*, 22:811–877.

- Landau, I. (2010). The explicit syntax of implicit arguments. *Linguistic Inquiry*, 41(3):357–388.
- Landau, I. (2015). *A Two-Tiered Theory of Control*. MIT Press, Cambridge, MA.
- Larson, R. K. (1988). On the double object construction. *Linguistic Inquiry*, 19(3):335–391.
- Larson, R. K. (2010). On Pyllkänen’s semantics for low applicatives. *Linguistic Inquiry*, 41:701–704.
- Lasnik, H. (2002). Clause-mate conditions. In *Proceedings of the 2002 International Conference on Korean Linguistics*, pages 386–393, Seoul. The Association for Korean Linguistics.
- Legate, J. A. (2012). Subjects in Acehnese and the nature of the passive. *Language*, 88(2):495–525.
- Legate, J. A. (2014). *Voice and v: Lessons from Acehnese*. MIT Press, Cambridge, MA.
- Legate, J. A. (2017). The locus of ergative case. In Coon, J., Massam, D., and Travis, L. D., editors, *The Oxford handbook of ergativity*, pages 135–158. Oxford University Press.
- Legate, J. A. (2021). Noncanonical Passives: A Typology of Voices in an Impoverished Universal Grammar. *Annual Review of Linguistics*, 7:157–176.
- Legate, J. A. and Akkuş, F. (2017). Turkish passive impersonals. Paper presented at the 48th meeting of the North East Linguistic Society, University of Iceland, Iceland.
- Legate, J. A., Akkuş, F., Šereikaitė, M., and Ringe, D. (2020). On passives of passives. *Language*, 96(4):771–818.
- Lewis, D. (1975). Adverbs of quantification. In Keenan, E. L., editor, *Formal Semantics of Natural Language*, pages 3–15. Cambridge University Press, Cambridge.
- Lewis, D. (1979). Scorekeeping in a language game. *Journal of Philosophical Logic*, pages 339–359.

- Li, D. (2020). Pro Controlee and Finite Control in Mandarin. Ms., University of Pennsylvania.
- Lipták, A. (1998). Focus and ecm. In Cambier-Langeveld, T., Lipták, A., and Redford, M., editors, *Proceedings of Console VI*, pages 153–168. HIL.
- Longobardi, G. (1994). Reference and proper names: A theory of N-movement in syntax and logical form. *Linguistic Inquiry*, pages 609–665.
- Lundin, K. (2003). *Small Clauses in Swedish: Towards a Unified Account*. PhD thesis, Lund University.
- Malamud, S. A. (2013). (in)definiteness-driven typology of arbitrary items. *Lingua*, 126:1–31.
- Malchukov, A. and Siewierska, A. (2011). *Impersonal Constructions: A cross-linguistic perspective*. John Benjamins, Philadelphia, PA.
- Maling, J. (2010). Unpassives of Unaccusatives. In Donna B. Gerdts, J. M. and Polinsky, M., editors, *Hypothesis A/Hypothesis B: Linguistic Explorations in Honor of David M. Perlmutter*, pages 275–292. MIT Press.
- Manning, C. D. (1996). *Ergativity: Argument Structure and Grammatical Relations*. CSLI Publications, Stanford, CA.
- Marantz, A. (1991). Case and licensing. In Westphal, G. F., Ao, B., and Chao, H., editors, *ESCOL '91: Proceedings of the Eighth Eastern States Conference on Linguistics*, pages 234–253. Baltimore.
- Marantz, A. (1993). Implications of Asymmetries in Double Object Constructions. In Mchombo, S. A., editor, *Theoretical Aspects of Bantu Grammar*, pages 113–152. Stanford: CSLI Publications.
- Marantz, A. (2008). Phases and words. In Choe, S.-H., editor, *Phases in the theory of grammar*, pages 191–222. Dong In.

- Martí, L. (2011). Implicit indefinite objects: grammar, not pragmatics. *Unpublished ms.*, Queen Mary University of London, UK.
- Massam, D. (2001). Pseudo noun incorporation in Niuean. *Natural Language & Linguistic Theory*, 19:153–197.
- Matsuoka, M. (2013). On the notion of subject for subject-oriented adverbs. *Language*, 89(3):586–618.
- McCloskey, J. (2007). The Grammar of Autonomy in Irish. *Natural Language & Linguistic Theory*, 25(4):825–857.
- McCloskey, J. and Hale, K. (1984). On the syntax of person-number inflection in modern Irish. *Natural Language & Linguistic Theory*, 1(4):487–534.
- McFadden, T. (2004). *The position of morphological case in the derivation*. PhD thesis, University of Pennsylvania.
- McGinnis, M. (1998). Locality and inert case. In Tamanji, P. and Kusumoto, K., editors, *Proceedings of NELS 28*, pages 267–281. GLSA Publications.
- McGinnis, M. (2001). Variation in the phase structure of applicatives. *Linguistic Variation Yearbook*, 1:105–146.
- Merchant, J. (2013). Voice and ellipsis. *Linguistic Inquiry*, 44(1):77–108.
- Miyagawa, S. (1998). (s)ase as an elsewhere causative and the syntactic nature of words. *Journal of Japanese linguistics*, 16(1):67–110.
- Miyagawa, S. (1999). Causatives. In Tsujimura, N., editor, *The Handbook of Japanese Linguistics*. Blackwell Publishers, Massachusetts and Oxford, UK.
- Moltmann, F. (2006). Generic one, arbitrary PRO, and the first person. *Natural language semantics*, 14(3):257–281.

- Moulton, K. (2009). Clausal complementation and the *wager*-class. In Schardl, A., Walkow, M., and Abdurrahman, M., editors, *Proceedings of the 38th annual meeting of the North East Linguistic Society (NELS 38)*, pages 165–178.
- Müller, G. (2010). On deriving CED effects from the PIC. *Linguistic Inquiry*, 41:35–82.
- Müller, G. (2014). On the short life cycle of external arguments in passive derivations. University of Leipzig, ms.
- Murphy, A. (2014). Stacked passives in Turkish. In Assmann, A., Bank, D., Georgi, T., Klein, P., and Zimmermann, E., editors, *Topics as InfL*, pages 263–304. Linguistische Arbeits Berichte, Universität Leipzig.
- Nakipoğlu, M. and Üntak, A. (2008). A complete verb lexicon of turkish based on morphemic analysis. *Turkic Languages*, 12:221–80.
- Nakipoğlu-Demiralp, M. (2001). The referential properties of the implicit arguments of impersonal passive constructions. In Taylan, E. E., editor, *The verb in Turkish*, pages 129–150. John Benjamins, Amsterdam/Philadelphia.
- Nash, L. (2017). Causees are not agents. manuscript, Linguistic Perspectives on Causation. HUJI, June 30th.
- Neeleman, A. and Szendrői, K. (2007). Radical pro drop and the morphology of pronouns. *Linguistic Inquiry*, 38:671–714.
- Nerbonne, J. A. (1982). Some passives not characterized by universal rules: Subjectless impersonal. In Joseph, B., editor, *Grammatical relations and relational grammar*, pages 59–92. Department of Linguistics, Ohio State University, Columbus.
- Ngoboka, J. P. (2005). *A syntactic analysis of Kinyarwanda applicatives*. PhD thesis, University of KwaZulu-Natal.
- Nie, Y. (2020). *Licensing arguments*. PhD thesis, New York University.

- Oltra-Massuet, I. (2013). *Deverbal Adjectives at the interface: a crosslinguistic investigation into the morphology, syntax and semantics of-ble*, volume 28. Walter de Gruyter.
- Ostler, N. D. M. (1979). *Case-Linking: A theory of case and verb diathesis applied to Classical Sanskrit*. PhD thesis, Massachusetts Institute of Technology.
- Ouwayda, S. and Shlonsky, U. (2016). The Wandering Subjects of the Levant: “Verbal Complexes” in Lebanese Arabic as Phrasal Movement. *Brill’s Journal of Afroasiatic Languages and Linguistics*, 8(1):136–153.
- Özkaragöz, I. (1980). Evidence from Turkish for the unaccusative hypothesis. *Proceedings of the Sixth Annual Meeting of the Berkeley Linguistics Society*, pages 411–422.
- Özkaragöz, I. (1986). Monoclausal double passives in Turkish. In Slobin, D. I. and Zimmer, K., editors, *Studies in Turkish Linguistics*, pages 77–91. Benjamins, Amsterdam/Philadelphia.
- Özsoy, A. S. (2009). Argument structure, animacy, syntax and semantics of passivization in Turkish: A corpus-based approach. In Kawaguchi, Y., Minegishi, M., and Durand, J., editors, *Corpus Analysis and Variation in Linguistics*, pages 259–279. Benjamins, Amsterdam/Philadelphia.
- Öztürk, B. (2005). *Case, Referentiality and Phrase Structure*. John Benjamins, Amsterdam/Philadelphia.
- Özyıldız, D. (2017). Quantifiers in Turkish. In Paperno, D. and Keenan, E. L., editors, *Handbook of Quantifiers in Natural Language: Volume II*, pages 857–937. Springer.
- Özyıldız, D. (2020). Embedded clauses in Turkish: Both argumenthood and modification are paths to composition. Paper presented at the 94th LSA Annual Meeting.
- Pak, M., Portner, P., and Zanuttini, R. (2020). Person marking, status marking and three concepts of addressee. Paper presented at the 94th Annual Meeting of the Linguistic Society of America, New Orleans.

- Parsons, T. (1990). *Events in the Semantics of English*, volume 5. Cambridge, Ma: MIT Press.
- Pearson, H. (2013). *The sense of self: Topics in the semantics of de se expressions*. PhD thesis, Harvard University.
- Pearson, H. (2016). The semantics of partial control. *Natural Language & Linguistic Theory*, 34(2):691–738.
- Pearson, M. (2001). *The Clause Structure of Malagasy: A Minimalist Approach*. PhD thesis, UCLA.
- Perlmutter, D. M. (1982). Syntactic representation, syntactic levels, and the notion of subject. In Jacobson, P. and Pullum, G. K., editors, *The Nature of Syntactic Representation*, pages 283–340. Reidel, Dordrecht.
- Perlmutter, D. M. and Postal, P. M. (1977). Toward a universal characterization of the passive. In Whistler, K., van Valin, R. D. J., Chiarello, C., Jaeger, J. J., Petruck, M., Thompson, H., Javkin, R., and Woodbury, A., editors, *Proceedings of the 3rd Annual Meeting of the Berkeley Linguistics Society*, pages 394–417, Berkeley, CA. Berkeley Linguistics Society.
- Perlmutter, D. M. and Postal, P. M. (1984). The 1-Advancement Exclusiveness Law. In Perlmutter, D. M. and Rosen, C., editors, *Studies in Relational Grammar*, volume 2, pages 81–125. University of Chicago Press, Chicago, IL.
- Pesetsky, D. (1991). Zero Syntax: Infinitives. *Ms., MIT*.
- Pesetsky, D. (1995). *Zero Syntax*. MIT Press, Cambridge, MA.
- Pesetsky, D. (2016). Exfoliation: towards a derivational theory of clause size. In *Paper presented at the Shrinking Trees Workshop*.
- Pesetsky, D. (2018). Nominative Case and Finiteness: Arguments for Exfoliation. In *Handout of a talk given at Stanford University*.

- Pesetsky, D. (2019). Exfoliation: towards a derivational theory of clause size. In *Manuscript*.
- Pesetsky, D. and Torrego, E. (2007). The syntax of valuation and the interpretability of features. In Karimi, S., Samiian, V., and Wilkins, W. K., editors, *Phrasal and Clausal Architecture. Syntactic Derivation and Interpretation*, pages 262–294. John Benjamins, Philadelphia, PA.
- Pitteroff, M. (2014). *Non-canonical ‘sich lassen’ middles*. PhD thesis, University of Stuttgart.
- Pitteroff, M. (2015). Non-canonical middles: a study of personal let-middles in German. *The Journal of Comparative Germanic Linguistics*, 18(1):1–64.
- Pitteroff, M. and Schäfer, F. (2017). Implicit control cross-linguistically. manuscript.
- Pitteroff, M. and Schäfer, F. (2019). Implicit control crosslinguistically. *Language*, 95(1):136–184.
- Polinsky, M. (2017). Antipassive. In *The Oxford Handbook of Ergativity*. Oxford University Press.
- Pollock, J.-Y. (1985). On case and the syntax of infinitives in french. In Guéron, J., Obenauer, H. G., and Pollock, J., editors, *Grammatical Representation*, pages 293–326. Foris.
- Postal, P. (1986). *Studies of Passive Clauses*. State University of New York Press, Albany, NY.
- Postal, P. M. (1974). *On Raising*. MIT Press.
- Postal, P. M. (1993). Some defective paradigms. *Linguistic Inquiry*, 24(2):347–364.
- Preminger, O. (2013). That’s not how you agree: a reply to Zeijlstra. *The Linguistic Review*, 30:491–500.
- Preminger, O. (2014). *Agreement and its failures*, volume 68. MIT Press.

- Primus, B. (2011). Animacy and telicity: Semantic constraints on impersonal passives. *Lingua*, 121:80–99.
- Pylkkänen, L. (2002). *Introducing Arguments*. PhD thesis, MIT.
- Pylkkänen, L. (2008). *Introducing arguments*. MIT Press, Cambridge, MA.
- Rackowski, A. and Richards, N. (2005). Phase edge and extraction: A tagalog case study. *Linguistic Inquiry*, 36(4):565–599.
- Ramchand, G. (2006). Direct and indirect causation in Hindi. In *Paper presented at the Workshop on Clitics, Intonation and Causatives*.
- Ramchand, G. C. (2008). *Verb Meaning and the Lexicon: A First-Phase Syntax*. Cambridge University Press, Cambridge.
- Reed, L. A. (2018). Against control by implicit passive agents. In *Romance Languages and Linguistic Theory 14: Selected papers from the 46th Linguistic Symposium on Romance Languages (LSRL)*, volume 14, pages 279–292. John Benjamins.
- Rezac, M. (2013). Case and licensing: evidence from ECM + DOC. *Linguistic Inquiry*, 44(2):299–319.
- Rezac, M. and Joutteau, M. (2016). The ways of referential deficiency: Impersonal *on* and its kin. CNRS-IKER ms, available at: http://www.iker.cnrs.fr/IMG/pdf/rezac_joutteau.impersonal.pdf.
- Rezac, M. and Joutteau, M. (2017). The ways of referential deficiency: Impersonal *on* and its kin. manuscript.
- Richards, N. (2001). *Movement in language: Interactions and architectures*. Oxford University Press.
- Richards, N. (2010). *Uttering trees*, volume 56. MIT Press.
- Rizzi, L. (1982). *Issues in Italian Syntax*. Foris, Dordrecht.

- Rizzi, L. (1986). Null objects in Italian and the theory of pro. *Linguistic Inquiry*, 17:501–557.
- Rochette, A. (1988). *Semantic and syntactic aspects of Romance sentential complementation*. PhD thesis, MIT.
- Roeper, T. (1987). Implicit arguments and the head-complement relation. *Linguistic Inquiry*, 18:267–310.
- Saad, G. N. (1982). *Transitivity, causation, and passivization: a semantic-syntactic study of the verb in classical Arabic*, volume 4. Kegan Paul International.
- Schäfer, F. (2008). *The Syntax of (Anti-)Causatives*. John Benjamins, Amsterdam/Philadelphia.
- Schäfer, F. (2012). The passive of reflexive verbs and its implications for theories of binding and case. *The Journal of Comparative Germanic Linguistics*, 15(3):213–268.
- Schäfer, F. (2017). Romance and Greek medio-passives and the typology of Voice. In D’Alessandro, R., Franco, I., and Ángel J. Gallego, editors, *The Verbal Domain*, pages 129–152. Oxford University Press.
- Sells, P. (1987). Aspects of logophoricity. *Linguistic Inquiry*, 18:445–479.
- Şener, S. (2008). Non-canonical case licensing is canonical: Accusative subjects of CPs in Turkish. manuscript.
- Şener, S. (2011). Cross clausal licensing of Accusative case on subjects of CPs in Turkish. In Lima, S., Mullin, K., and Smith, B., editors, *NELS 39: Proceedings of the 39th annual meeting of the North East Linguistic Society*, pages 679–690. Amherst, MA: GLSA Publications.
- Shibatani, M. (1972). Three reasons for not deriving ‘kill’ from ‘cause to die’ in Japanese. In *Syntax and Semantics Volume 1*, pages 125–137. Academic Press.
- Sigurðsson, E. F. and Wood, J. (2018). On the subject of subjectless ‘let’ complements. *Paper presented at the 42nd Penn Linguistic Conference (PLC42)*.

- Soltan, U. (2007). *On formal feature licensing in minimalism: Aspects of Standard Arabic morphosyntax*. PhD thesis, University of Maryland.
- Soltan, U. (2019). On sluicing and its kin in Egyptian Arabic. In *Talk given at the 33rd Annual Symposium on Arabic Linguistics*.
- Speas, M. (1994). Null arguments in a theory of economy of projection. In Benedicto, E. and Runner, J., editors, *University of Massachusetts occasional papers in linguistics*, pages 179–208. University of Massachusetts, GLSA, Amherst.
- Speas, M. (2006). Economy, agreement and the representation of null arguments. In Ackema, P., Brandt, P., Schoorlemmer, M., and Weerman, F., editors, *Arguments and agreement*, pages 35–75. Oxford University Press, Oxford.
- Stiebels, B. (2002). *Typologie des Argumentlinkings: Ökonomie und Expressivität*. Akademie, Berlin.
- Stromdahl, L. and Nematova, S. (2019a). Configurational Case is Needed to Explain Promotion to Subject in Uzbek Passives. In *Proceedings of NELS 49*.
- Stromdahl, L. and Nematova, S. (2019b). Optionality in Uzbek: Dative Causees vs. *by*-Phrases. In *Poster at GLOW 42*.
- Stromdahl, L. and Nematova, S. (2020). Transitivity and Causative Constructions. *Slides from University of Delaware SySeL*.
- Tan, T. L. and Köhler, N. (2019). The Double Duty of the Sakha “Passive”. Abstract for the 5th Workshop on Turkic and languages in contact with Turkic (Tu+5).
- Taraldsen, K. T. (1984). Some phrase structure dependent differences between Swedish and Norwegian. In *Working Papers in Scandinavian Syntax 9*, pages 1–45.
- Timberlake, A. (1982). The impersonal passive in Lithuanian. In *Proceedings of the eighth annual meeting of the Berkeley Linguistics Society*, pages 508–524.

- Tonyah, N. (2015). Non-structural datives in Turkish. Master's thesis, Boğaziçi University.
- Tucker, M. A. (2011). The morphosyntax of the Arabic verb: Toward a unified syntax-prosody. In *Morphology at Santa Cruz: Papers in Honor of Jorge Hankamer*, pages 177–211. Santa Cruz.
- Turan, Ü. D. (1996). *Null vs. overt subjects in Turkish discourse: A centering analysis*. PhD thesis, University of Pennsylvania.
- Ura, H. (1993). On feature-checking for *wh*-traces. In Bobaljik, J. D. and Phillips, C., editors, *Papers on case and agreement*, pages 215–242. MIT working papers in linguistics. MIT Press.
- van Urk, C. (2013). Visser's generalization: The syntax of control and the passive. *Linguistic Inquiry*, 44:168–178.
- Van Urk, C. (2015). *A uniform syntax for phrasal movement: A case study of Dinka Bor*. PhD thesis, Massachusetts Institute of Technology.
- Van Urk, C. and Richards, N. (2015). Two components of long-distance extraction: Successive cyclicity in dinka. *Linguistic Inquiry*, 46(1):113–155.
- von Stechow, A. (1996). The different readings of *wieder* “again”: A structural account. *Journal of semantics*, 13(2):87–138.
- Šereikaitė, M. (2018). Active Existential Voice In Lithuanian: Burzio's generalization revised. Talk at the 92nd Annual Meeting of the Linguistic Society of America (LSA).
- Šereikaitė, M. (2020). Active Existential Voice In Lithuanian: Remarks on Burzio's generalization. *Linguistic Inquiry*, pages 1–78.
- Williams, A. (2015). *Arguments in syntax and semantics*. Cambridge University Press.
- Williams, E. (1980). Predication. *Linguistic Inquiry*, 11(1):203–238.

- Williams, E. (1985). PRO and subject of NP. *Natural Language & Linguistic Theory*, 3(3):297–315.
- Williams, E. (1987). Implicit arguments, the binding theory, and control. *Natural Language & Linguistic Theory*, 5:151–180.
- Wood, J. (2011). Icelandic let-causatives and case. In *Working Papers in Scandinavian Syntax 87*, pages 1–52.
- Wood, J. (2015). *Icelandic morphosyntax and argument structure*, volume 90. Springer.
- Wood, J. and Á. Sigurðsson, H. (2014). Let Causatives and (A)symmetric Dat-Nom Constructions. *Syntax*, 17(3):269–298.
- Woolford, E. (2003). Burzio’s generalization, markedness, and constraints on nominative objects. In Brandner, E. and Zinsmeister, H., editors, *New perspectives on case theory*, pages 301–329. CSLI Stanford.
- Woolford, E. (2015). Ergativity and transitivity. *Linguistic Inquiry*, 46(3):489–531.
- Wunderlich, D. (1997). Cause and the structure of verbs. *Linguistic Inquiry*, 28:27–68.
- Wurmbrand, S. (2001). *Infinitives: Restructuring and clause structure*. Mouton de Gruyter, Berlin/New York.
- Wurmbrand, S. (2007). How complex are complex predicates? *Syntax*, 10(3):243–288.
- Wurmbrand, S. (2014). The merge condition: A syntactic approach to selection. In Kosta, P., Schürcks, L., Franks, S., and Radev-Bork, T., editors, *Minimalism and Beyond: Radicalizing the interfaces*, pages 139–177. John Benjamins, Amsterdam.
- Wurmbrand, S. (2016). Trying my best to control implicitly. Paper presented at Control Workshop, Berlin, Germany.
- Wurmbrand, S. (2017). Stripping and topless complements. *Linguistic Inquiry*, 48(2):341–366.

- Wurmbrand, S. and Shimamura, K. (2017). The features of the voice domain: actives, passives, and restructuring. In d'Alessandro, R., Franco, I., and Gallego, A., editors, *The verbal domain*, pages 179–204. Oxford University Press, Oxford.
- Yakut, A. B. (2013). Syntax of Sason Arabic: A Descriptive Review. *Manuscript, Boğaziçi University*.
- Yang, C. (2016). *The Price of Linguistic Productivity*. MIT Press, Cambridge, MA.
- Yarar, E. (2016). An analysis of *insan* and *insanlar* as impersonal pronouns in Turkish. manuscript.
- Yıldırım-Gündoğdu, H. (2017). The structure of *diye* clauses in Turkish. Master's thesis, Boğaziçi University.
- Zaenen, A., Maling, J., and Thráinsson, H. (1985). Case and grammatical functions: The Icelandic passive. *Natural Language & Linguistic Theory*, 3(4):441–483.
- Zeijlstra, H. (2012). There is only one way to agree. *The Linguistic Review*, 29:491–539.
- Zidani-Eroğlu, L. (1997). Exceptionally case-marked NPs as matrix objects. *Linguistic Inquiry*, pages 219–230.
- Zimmer, K. E. (1976). Some constraints on turkish causativization. In Shibatani, M., editor, *The grammar of causative constructions*, pages 399–412. Academic Press, New York.
- Zubizarreta, M. L. (1985). The relation between morphophonology and morphosyntax: The case of Romance causatives. *Linguistic Inquiry*, 16(2):247–289.