

AN EXAMINATION AND ANALYSIS OF FUGA'S  
*SCALINATA DELLE UNDICI FONTANE AND PROSPETTIVA*

Lisa Marie Sardegna

A THESIS

in

Historic Preservation

Presented to the Faculties of the University of Pennsylvania in  
Partial Fulfillment of the Requirements for the Degree of

MASTER IN SCIENCE

2005

---

Advisor  
Frank G. Matero  
Professor of Architecture

---

Reader  
Ernesto Borrelli  
Laboratory Coordinator  
International Centre for the Study of  
the Preservation and Restoration of  
Cultural Property

---

Graduate Committee Chair  
Frank G. Matero  
Professor of Architecture

## ACKNOWLEDGEMENTS

I would like to thank several people for their crucial roles in the completion of this thesis.

I would like to express my gratitude to many people in Rome for their knowledge, time, and support: Dr. Anna Lucia Francesconi and the staff of the Orto Botanico; Ernesto Borrelli and his laboratory staff, and the library staff at ICCROM; Prof. Francesco Scoppola at La Sapienza; Arch Gionata Rizzi; and Dr. Ann Pulver and Arch. Francesco Siravo.

More generally, I would like to thank the people of Rome who are so proud of their beautiful city and its history, especially Mr. Agostini who closed his shop in the middle of the day to take me to see an example of cortina which was being restored.

At the University of Pennsylvania, I owe a great debt of gratitude to Prof. Frank Matero for sharing his knowledge and giving his guidance, and to Rynta Fourie who was always willing to lend support.

I owe special gratitude to Dr. Carl Grimm and Patricia O'Regan at the San Francisco Fine Arts Museums for the introduction to the field of conservation, and for their continuing support.

Thank you to my parents, Carl and Pam, for their support and unwavering confidence that I could do anything that I wanted, and to David for being my voice of reason, my guiding star, and my anchor for so long.

## TABLE OF CONTENTS

TITLE PAGE .....	i
ACKNOWLEDGEMENTS .....	ii
TABLE OF CONTENTS .....	iii
LIST OF FIGURES .....	iv
INTRODUCTION .....	1
METHODOLOGY .....	5
Visual Examination .....	5
Archival Evidence .....	9
Material Samples .....	10
SITE HISTORY .....	12
The Villa Riario .....	12
Christina of Sweden .....	17
The Villa Corsini .....	20
Orto Botanico .....	21
ARCHITECTURAL STYLE .....	23
Nymphaeum .....	23
Ferdinando Fuga .....	27
The <i>Prospettiva (Nicchione)</i> .....	29
<i>Scalinata delle Undici Fontane</i> .....	31
FINISH ANALYSIS .....	36
Travertine color .....	37
Cortina color .....	43
MORTAR ANALYSIS .....	53
EXISTING CONDITIONS .....	62
<i>Scalinata</i> .....	62
<i>Prospettiva</i> .....	67
CONCLUSIONS .....	70
BIBLIOGRAPHY .....	72
APPENDIX A: SAMPLE LOCATIONS .....	74
APPENDIX B: TABLES OF SAMPLES .....	77
<i>Scalinata</i> Samples .....	77
<i>Prospettiva</i> Samples .....	81
Mortar Samples .....	83
Munsell Color Reference .....	85
INDEX .....	88

## LIST OF FIGURES

Figure 1.1	The <i>Scalinata delle Undici Fontane</i> . . . . .	2
Figure 1.2	The <i>prospettiva</i> . . . . .	3
Figure 2.1	Partitioning of site into study areas . . . . .	6
Figure 2.2	Typical tuff stone ranging in color from buff to yellow in the old scalinata walls. . . . .	7
Figure 2.3	Unusual red-brown tuff stones. . . . .	8
Figure 3.1	Detail of DuPerac’s map of 1577 Rome. . . . .	13
Figure 3.2	Detail of Paoli’s map of 1623 Rome. . . . .	14
Figure 3.3	Detail of eighteenth century plan of the site . . . . .	15
Figure 3.4	Detail of an early eighteenth century bird’s eye view of the Villa Riario. The <i>prospettiva</i> and the lateral stairs are visible. . . . .	16
Figure 3.5	Detail of Nolli’s 1748 map of Rome . . . . .	17
Figure 3.6	Detail of Pollastri’s plan of the site in 1873 . . . . .	18
Figure 3.7	Axial views from the top of the <i>scalinata</i> (top) and from the <i>Fontana dei Tritoni</i> (bottom). . . . .	19
Figure 4.1	Fuga’s drawing of the “Fontana delle Prospettive” . . . . .	28
Figure 4.2	The water stair and nymphaeum at Villa Aldobrandini . . . . .	29
Figure 4.3	View of the “green theater” setting created by Fuga . . . . .	30
Figure 4.4	An example of travertine and cortina finishes used on the Capitoline Palaces. . . . .	32
Figure 5.1	Locations of samples exhibiting travertine colored limewash . . . . .	37
Figure 5.2	An example of the yellow and cream travertine color from a decorative element (SC-009 at 25x magnification) . . . . .	38

Figure 5.3	An example of cream travertine color from a frame element (SC-013 at 25x magnification) . . . . .	39
Figure 5.4	An example of a modern repair of a light colored area (Sample SC-015 at 25x magnification). . . . .	40
Figure 5.5	An example of the yellow and cream travertine color from a frame element (Sample SC-017 at 25x magnification). . . . .	41
Figure 5.6	An example of and cream travertine color from a <i>prospettiva</i> frame element (Sample NI-008 at 25x magnification) . . . . .	42
Figure 5.7	Locations of samples with cortina colored limewash layers . . . . .	43
Figure 5.8	An example of the pink cortina color from an interior field (Sample SC-008 at 25x magnification). . . . .	44
Figure 5.9	An anomalous example of brick colored finish from a pilaster (Sample SC-012 at 25x magnification). . . . .	45
Figure 5.10	An example of the pink cortina color from an interior field element (Sample SC-014 at 25x magnification). . . . .	46
Figure 5.11	Watercolor depicting the top of the scalinata, 1780 . . . . .	47
Figure 5.12	water color depicting the scalinata, 1867 . . . . .	49
Figure 5.13	Exposed site of sample SC-012. The grey field below the exposed orange finish plaster appears to be a more recent repair. . . . .	50
Figure 5.14	Theoretical eighteenth century finish scheme. . . . .	51
Figure 5.15	Theoretical nineteenth century finish scheme. . . . .	52
Figure 6.1	Locations of the samples chosen for mortar analysis. . . . .	53
Figure 6.2	Sample M-001 (25x magnification) . . . . .	54
Figure 6.3	Sample M-006 (25x magnification) . . . . .	55
Figure 6.4	Sample M-007 (25x magnification) . . . . .	56

Figure 6.5	
Sample M-008 (25x magnification) . . . . .	57
Figure 6.6	
Sample M-009 (25x magnification . . . . .)	58
Figure 7.1	
Examples of finish materials and conditions found on the north rusticated wall of the <i>scalinata</i> . . . . .	63
Figure 7.2	
Pitted travertine surface on the <i>scalinata</i> baluster. . . . .	64
Figure 7.3	
Displaced masonry on the <i>scalinata</i> near the plane trees. . . . .	64
Figure 7.4	
Crystallized salt within plaster shown in UV photomicrograph (Sample SC-008 at 25x magnification). . . . .	66
Figure 7.5	
Example of damage to <i>spugne</i> textured surface caused by roots . . . . .	68
Figure 7.6	
Biogrowth on <i>prospettiva</i> . . . . .	69
Figure A.1	
Locations of the samples collected from the <i>prospettiva</i> . . . . .	74
Figure A.2	
Locations of the samples collected from the north wall of the <i>scalinata</i> . . . . .	75
Figure A.3	
Locations of the samples collected from the south wall of the <i>scalinata</i> . . . . .	76
Table 6.1	
Comparison of the analyzed mortars . . . . .	61

# 1. INTRODUCTION

In the early eighteenth century, Neri Corsini renovated his newly purchased palazzo on Rome's Via Lungara. Architect Ferdinando Fuga was hired by Corsini to oversee the expansion of the former sixteenth century Riario villa as well as the remodeling of the expansive gardens connected to the villa. Several features were constructed in the garden, including the *Fontana dei Tritoni* and the *Scalinata delle Undici Fontane*, the latter a water-stair type fountain composed of a monumental staircase with a cascading fountain bisecting the uppermost portion (*Figure 1.1*). These two structures were positioned in line with the central axis of the original palazzo, and in line with a large nymphaeum style niche structure, called a *grande prospetto* by Fuga<sup>1</sup>, on the hill above the water-stair. It is with this *prospetto* and the *scalinata* that this thesis is concerned. While similarities exist between these two elements, they are not contemporaneous, and instead are the final result of numerous building campaigns.

This thesis includes the examination of historic documentary sources and physical evidence to determine a theoretical construction sequence for the *scalinata* and *prospettiva*, and an in-depth study of their surface finishes. Historic sources include maps, secondary sources which catalogue archival documents and anecdotal evidence, and artwork portray-

---

1. This large niche structure is referred to as *un grande prospetto* by Fuga (see: Enzo Borsellino, *Palazzo Corsini alla Lungara* (Rome: Schena Editore, 1988), p. 239), a *prospettiva* in a receipt for painting done (ibid., p. 151), and a *prospettiva* or *grande nicchia in muratura* by Borsellino (ibid., p. 43 and p. 57). This structure is commonly referred to as the *nicchione* in the present day. In this document, these terms all refer to the niche structure.



*Figure 1.1: The Scalinata delle Undici Fontane (Sardegna, 2003)*

ing the garden and its features. Samples of plasters and mortars taken from the group are analyzed and compared to determine the evolution and appearance of the features over time, including past repairs and renovations.

The *scalinata* appears to have been built upon older structures preexisting on the site, continuing an earlier *prospetto*. Both features are nymphae type structures with rusticated finishes, yet there are differences in construction methods, and subtle stylistic dissimilarities. Despite its grand appearance, the *prospetto* is a modest structure, constructed of brick with a plaster skin. The *scalinata* incorporates the materials of the *prospetto*, but also employs travertine which is completely lacking in the *prospetto*. The *scalinata* shows Fuga's ability to reference the past designs while incorporating current tastes in an integrated creation.





Figure 1.2: The *prospettiva* (University of Pennsylvania, *The Orto Botanico and the Scala d'Acqua of Rome*, 2002)

Fuga's *Scalinata delle Undici Fontane* is not a well known work<sup>1</sup>. Nonetheless, it is an important example of the Roman architectural tastes of its era. Colors and finishes similar to those employed in other seventeenth and eighteenth century Roman architecture are used to render the *scalinata* retaining walls. The renewed interest in the classical past so

1. While the Palazzo Corsini is discussed in detail in many documents, the *Scalinata delle Undici Fontane* is generally briefly mentioned. It is discussed at length in: Enzo Borsellino, *Palazzo Corsini alla Lungara* (Rome: Schena Editore, 1988), pp. 55-67 and Vania Cutuli, L'intervento di Ferdinando Fuga nel Giardino di Palazzo Corsini a Roma, Alfonso Gambardella, ed., *Ferdinando Fuga: 1699-1999: Roma, Napoli, Palermo* (Napoli: Edizioni Scientifiche Italiane, 2001) pp. 135-140.

prevalent in the sixteenth and seventeenth centuries can be seen in the incorporation of the *prospetto* into the design. Fuga's work reflects the Baroque sensibilities of his predecessors, with the addition of logical refinements of his times.

Through the analysis of historical sources and the physical evidence, it is possible to hypothesize the sequence and appearance of the group at different times in the development of the villa and gardens, especially regarding their finishes. While the group's architectural form has changed little since Fuga's intervention in 1741, the finishes have been renewed periodically. The finish layer stratigraphies found in the samples collected from both the *prospettiva* and *scalinata* show the evolution in colors and materials used.

The synthesis of the physical and documentary data result in a better understanding of the development of the site, including both the larger structural changes during its early history, and the more subtle alterations from recent repair and dilapidation.

## 2. METHODOLOGY

Before collecting material samples, the *scalinata* and the *prospettiva* were examined for physical evidence to determine construction methods and sequences, and to identify possible areas to collect representative samples of the various elements and material types. Anomalous materials and construction methods were also noted.

First hand and anecdotal evidence were considered in addition to the physical clues. Detailed maps, paintings and photographs depicting the site, compilations of receipts and correspondence, and compiled histories were compared in determining the construction history.

Once representative areas were chosen, samples were collected that represented the various types of finish and construction materials used in the *prospettiva* and the *scalinata*. Samples were collected from areas which were likely to have a full stratigraphy of the finishes from the time of construction to the present.

### 2.1 Visual Examination

In choosing the locations for collecting material samples, the site as a whole was first considered and examined visually. A preliminary partitioning of the site was achieved by noting differences in building styles and materials.

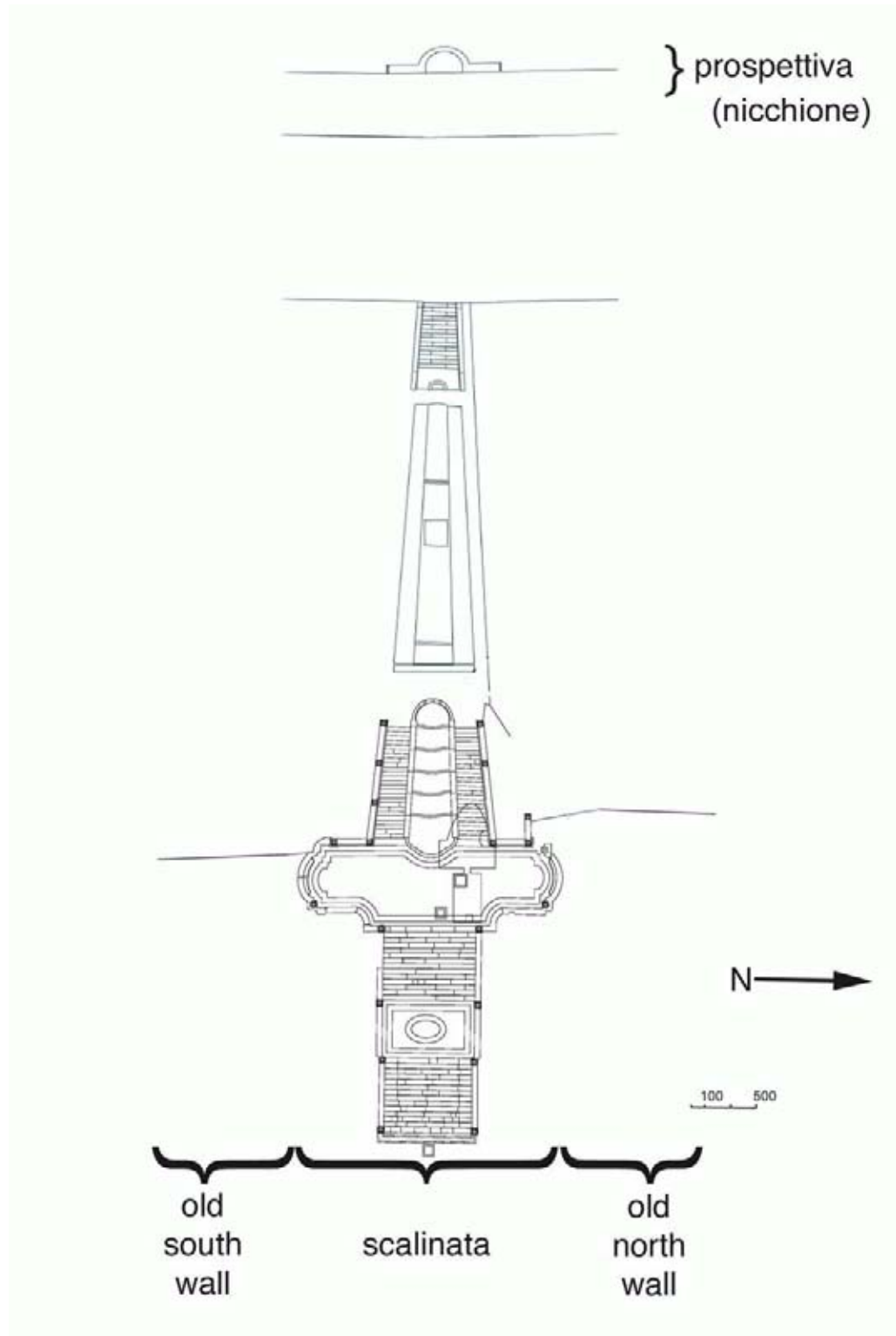

Figure 2.1: Partitioning of site into study areas (CAD Drawing: University of Pennsylvania, *The Orto Botanico and the Scala d'Acqua of Rome*, 2002)



*Figure 2.2:* Typical tuff stone ranging in color from buff to yellow in the old *scalinata* walls. (Sardegna, 2002)

The old walls that flank the *scalinata* are most notably from a different era. They are constructed from irregular tuff rock, instead of brick and travertine. What little finish surfaces remain are different as well. These walls appear to have been part of an earlier grotto rather than a nymphaeum. There are also elements which suggest that the north and south portions may not have been built at the same time, or were built by two groups of workers. Drains in these walls are of different configurations: those of the old south wall use bricks laid horizontally with the headers facing outward, and those of the old north wall use bricks laid vertically with the side edges facing outward. The stones also vary slightly in some places. There are small areas of irregularly shaped red-brown tuff (*Figure 2.3*) and yellow tuff in the old north wall that differ from the irregularly shaped tuff stones that vary

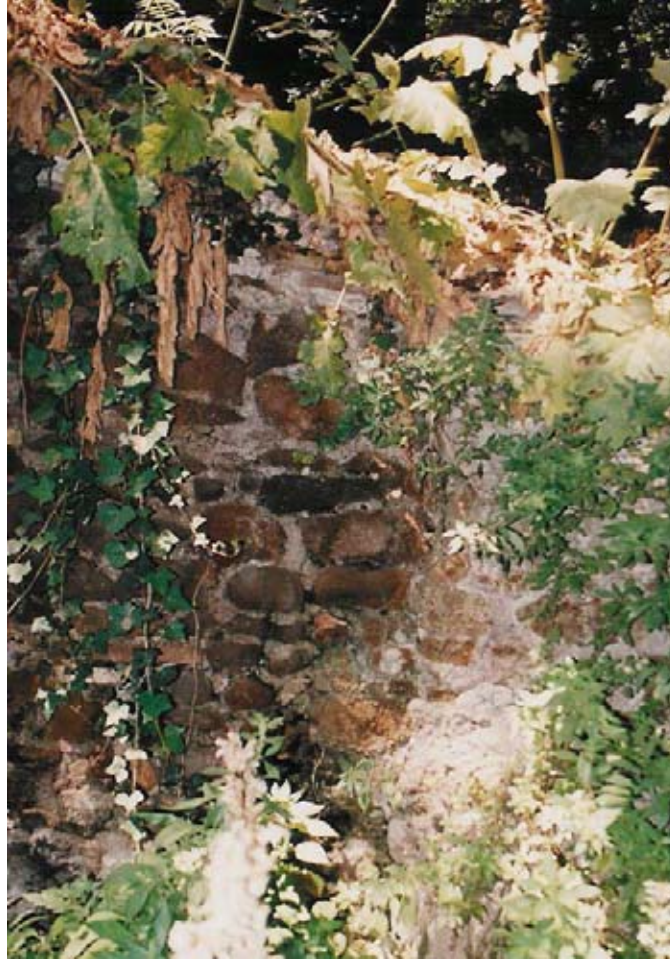

Figure 2.3: Unusual red-brown tuff stones. (Sardegna, 2002)

from buff to orange composing the largest part of the wall nearest to the *scalinata*. These unusual stones may be a repair or addition to the old north wall.

The *prospettiva* and the *scalinata* also appear to be from two different periods. Where the *scalinata* incorporates brick and travertine, the *prospettiva* was constructed solely with brick, its massive elements molded in plaster. The *prospettiva* is more ornately decorated

with small lozenges, a broken pediment, and a moulded shell which creates the ceiling of the niche. Many of the plaster elements were further embellished with natural coral rock.

The *nicchione* has not been well maintained over the years, so there is no evident patching. In fact there is a considerable amount of damaged or missing finishes from the structure. Probably because it is part of the Orto Botanico and receives more attention, the *scalinata* has been repaired several times since its construction, and repair and replacement of the stucco and finishes, as well as the stone texturing, is readily apparent.

This determination of dissimilar areas resulted in four study areas: the *Prospettiva*, the *Scalinata*, the old south wall, and the old north wall (*Figure 2.1*).

## **2.2 Archival Evidence**

Archival evidence was first examined to determine the construction history of the garden and villa, and the individual elements. This included maps, drawings and paintings, as well as a compilation of correspondence and original documents such as receipts. Histories of the area and its architectural traditions. A survey of the area conducted in 2002 by students from the University of Pennsylvania's European Studies course<sup>1</sup> was consulted as well, noting areas which were thought to be more recent repairs.

---

1. University of Pennsylvania, *The Orto Botanico and the Scala d'Acqua of Rome*, 2002, available at: <http://www.design.upenn.edu/hspv/rome/>

The preliminary partitioning of the site was supported by the evidence found in detailed maps of Rome. The evolution of structures on the site shown in the maps allowed a possible construction sequence to be determined for the elements of the present group.

Through the examination of texts and artwork, theoretical color schemes were formulated. Eighteenth century period images show a tradition of lighter frames around darker fields on the *scalinata*, so the colors found in texts could be verified. From this preliminary placement, areas were chosen for sampling from different architectural elements to confirm color palette theories.

### **2.3 Material Samples**

Material samples were collected during July 2003. Fifty samples were taken from the *scalinata* and the *nicchione*: 22 finish samples from the *scalinata*, 14 finish samples from the *nicchione*, and 14 mortar samples from the site as a whole. The finish samples were sorted into those from frame elements, those from interior field elements, and those from pilasters and other unique decorative elements. These samples were examined under a stereo binocular reflected light microscope at low magnification to determine the general features of the sample's microstructure and finish stratigraphy.

After preliminary examination, samples were typed and representative finish samples were selected for further investigation. The selected samples were the most promising



candidates for complete or well preserved evidence. These were mounted in Bioplast acrylic-polyester resin and cut and polished into cross sections. The cross sections were mounted on glass slides, and examined under normal and UV reflected light at 25x magnification.

Five of the mortar samples were selected to represent building campaigns: the *scalinata* retaining wall, collected from the north retaining wall where the finish is missing; the old north wall; the old south wall; and the *nicchione*. The five samples were cut into thin sections for comparison, and examined under normal reflected light and transmitted light at 25x magnification.

### 3. SITE HISTORY

The land that is presently Rome's Orto Botanico has a long complex history, beginning in antiquity. This area was known as the Horti Getae during the imperial Roman era. The site was outside the city walls, and therefore was not subject to Roman laws that prevented the construction of expansive palazzi and elaborate gardens within the city limits. The Horti Getae was one of several hillsides around Rome which were dotted with elaborate structures and large gardens containing fruit trees, grape vines, and other useful plants.<sup>1</sup>

#### 3.1 The Villa Riario

During the Renaissance, classical architecture enjoyed a revival, and ruins were studied for their value as design sources. The area surrounding Rome with their ruins were desirable for building new palazzi with gardens that incorporated the antiquities. In 1492, the site of the present Orto Botanico was purchased by Cardinal Raffaele Sanoni Riario.

Although a vineyard at the time of its purchase by Riario, the land was once the site of a Roman villa owing to the discovery of Roman statues.

Riario began the construction of a villa in 1510 after better roads were constructed along the Tiber, connecting the site to the rest of Rome. At this point, the Riario land remained outside the city walls, in the countryside. Like many wealthy Roman families of that time, the Riarios created a country estate, a villa suburbana, where they could create a large,

---

1. Marcello Fagiolo, *Roman Gardens* (New York: Monacelli Press, 2001) p. 9.

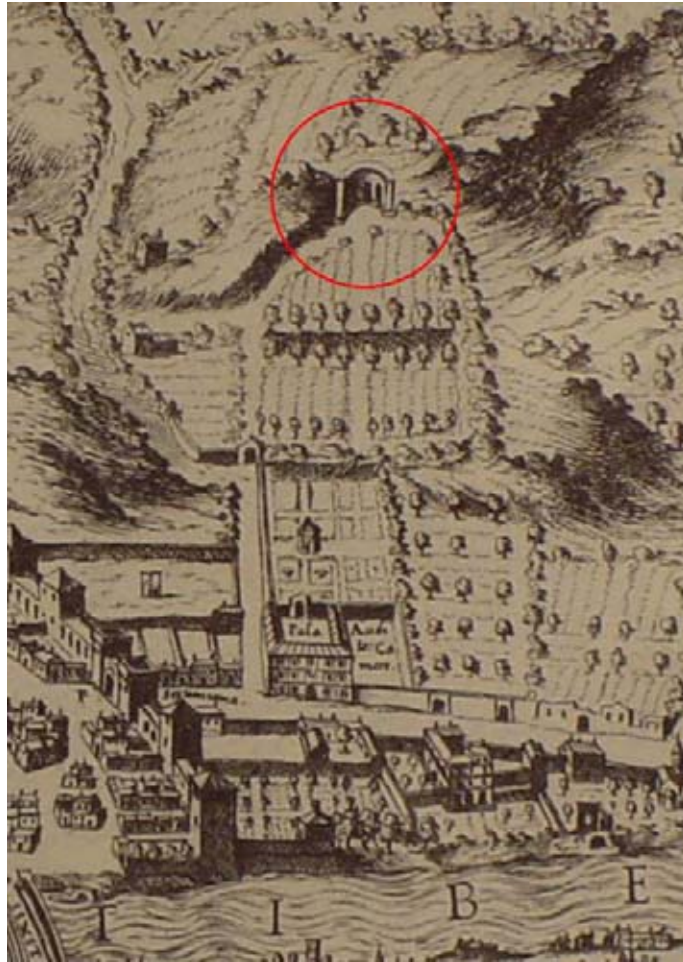

Figure 3.1: Detail of DuPerac's map of 1577 Rome (Frutaz, ed., *Le Piante di Roma*, vol II.)

ornate garden to accompany their house. A large U shaped villa was built, and formal gardens were designed on the adjacent land.

The gardens were laid out flanking a single axis centered on the villa. It is unclear when the *prospettiva* was built, but it seems likely that it was constructed during or soon after the construction of the palazzo by Riario in 1510. Vedute maps drawn by DuPerac in 1577 (Figure 3.1) and by Paoli in 1623 (Figure 3.2) each show a structure near where the *pros-*

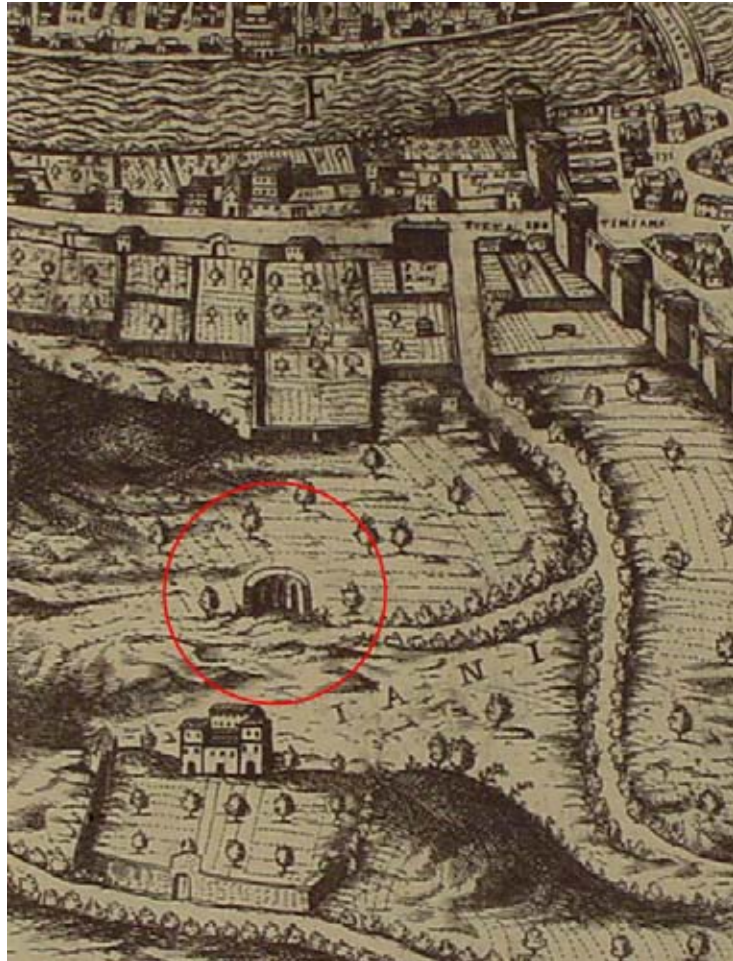

Figure 3.2: Detail of Paoli's map of 1623 Rome  
(Frutaz, ed., *Le Pianta di Roma*, vol II.)

*pettiva* is presently<sup>2</sup>. Both images depict a semicircular wall or exhedra with several niches, that resembles a nymphaeum. At this point, the *scalinata* has yet to appear, however this structure is situated near the axis of the original palazzo and terminates that axis at the edge of the cultivated garden (*Figure 3.1*). In both views, the structure is associated with a lateral path.

---

2. Amato Pietro Frutaz, ed., *Le Pianta di Roma*, vol II. (Rome: Istituto di Studi Romani, 1962).

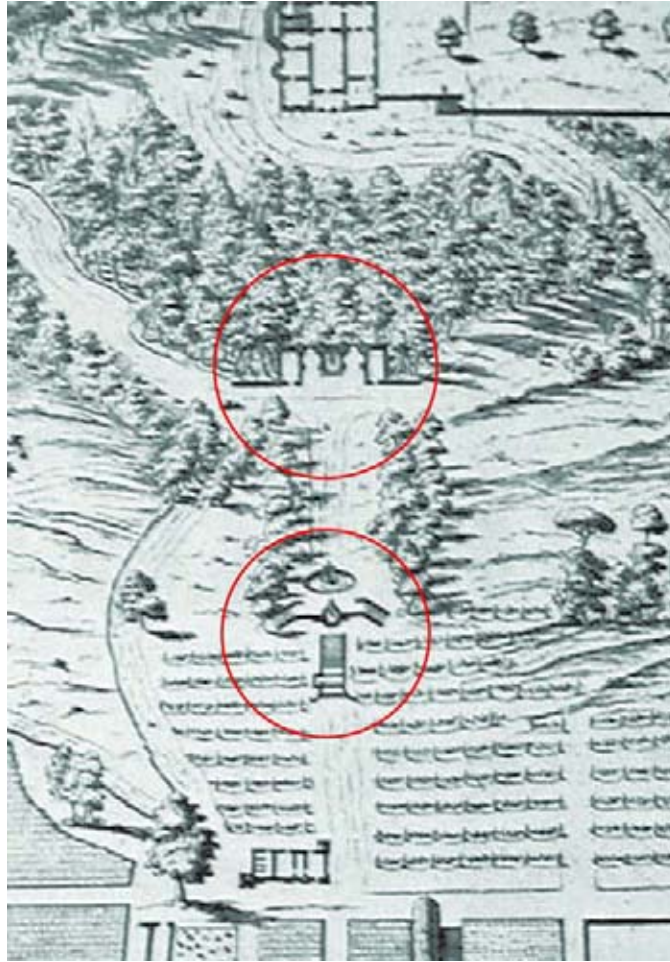
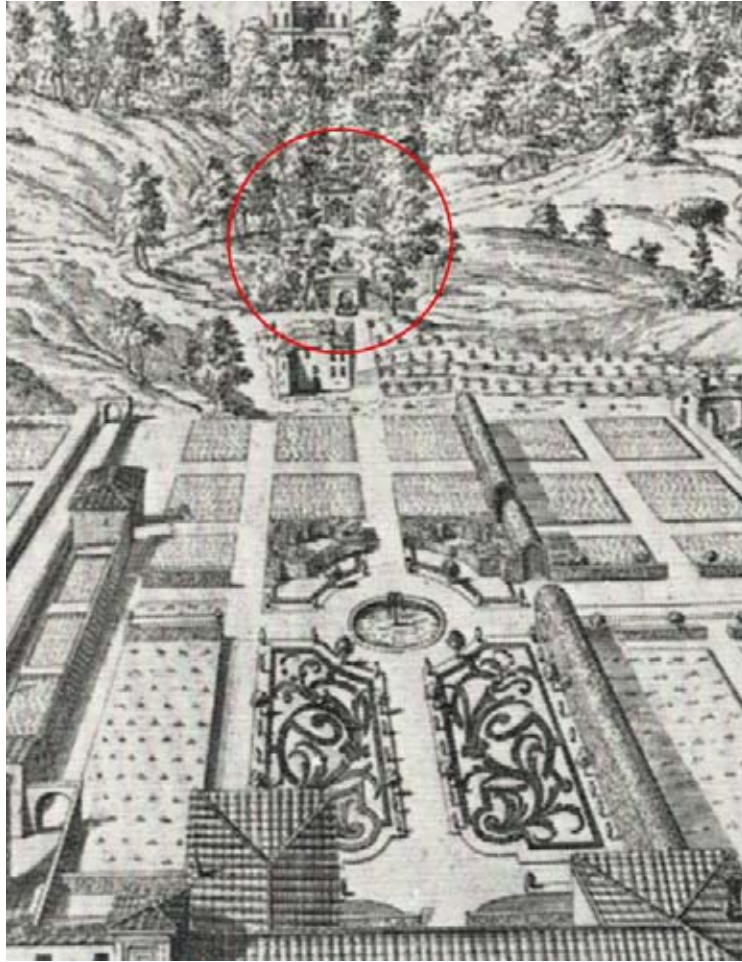

Figure 3.3: Detail of eighteenth century plan of the site, showing the *prospettiva* (above) and the precursor to the *scalinata* (below). (Firenze, Archivio Corsini)

A later plan from the beginning of the eighteenth century shows a more developed group of structures (Figure 3.3).<sup>3</sup> The *prospettiva* is linear rather than curved, and is composed of a large central niche flanked on either side by what appear to be two small rooms and retaining walls. The central niche appears to contain something, perhaps a fountain. The *scalinata* appears as a large flight of stairs on axis with the *prospettiva* and a pair of curved

---

3. Borsellino, Enzo, *Palazzo Corsini alla Lungara* (Rome: Schena Editore, 1988), p. 281.



*Figure 3.4:* Detail of an early eighteenth century bird's eye view of the Villa Riario. The *prospettiva* and the lateral stairs are visible. (Firenze, Archivio Corsini)

walls, each incorporating a smaller flight of steps. These two lateral stairs appear to be in the same position as the older retaining walls in the present *scalinata* and the entire feature may have been designed as an open grotto with rusticated walls and a central aedicula (*Figure 3.4*). Further upslope there is a circular fountain, but no stairs, where the water stair portion of the *scalinata* is presently located. It is also in this view that we begin to see reference to the planting of an allée of trees flanking the *scalinata*.

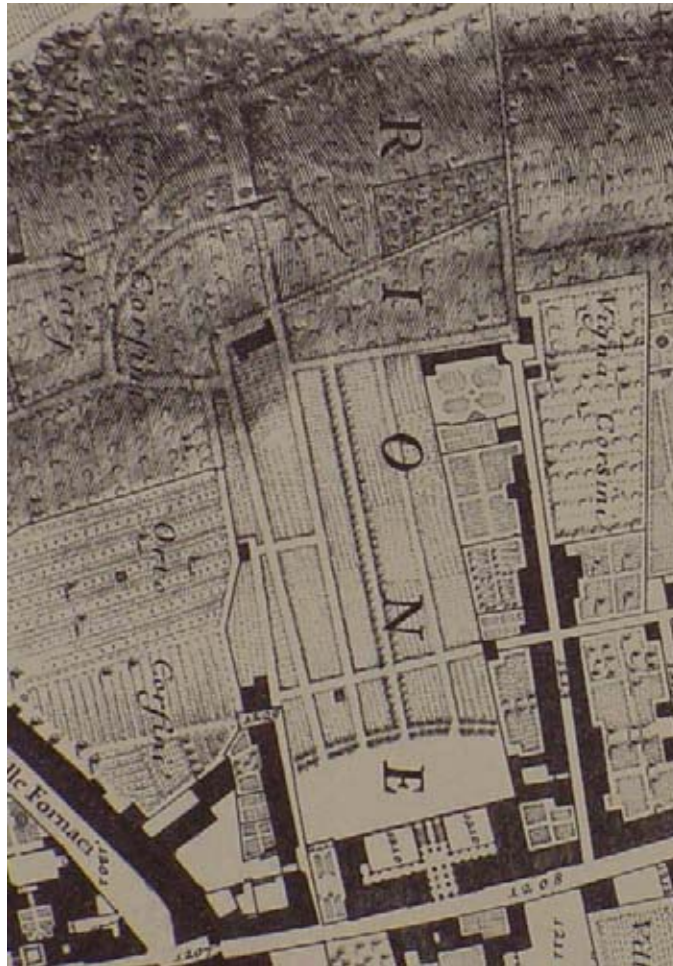

Figure 3.5: Detail of Nolli's 1748 map of Rome  
(Frutaz, ed., *Le Pianta di Roma*, vol II.)

### 3.2 Christina of Sweden

In 1659, Christina of Sweden took up residence at the Riario palazzo after she abdicated her throne, and remained until her death in 1689. During those thirty years, few changes were made to the property. Christina had many cultural interests, and the palazzo became a center of artistic and intellectual activity during her stay. Many of the changes that were made reflected her desire to better accommodate gatherings for the events she sponsored.

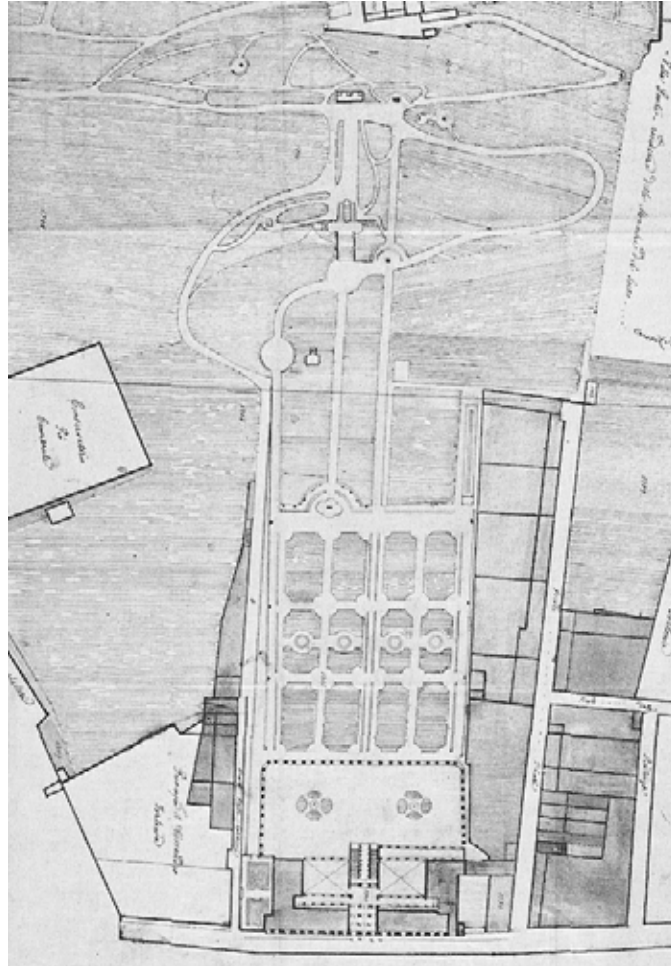

Figure 3.6: Detail of Pollastri's plan of the site in 1873  
(Firenze, Archivio Corsini)

These changes were primarily on the interior of the building. Two of the major changes that she implemented were the closure of the main entrance to the palazzo on the Via della Lungara and the addition of a secret staircase. Falda's map of Rome drawn in 1676 shows little change to the garden<sup>4</sup>. While the paths and parterres evolve slightly, the major structures remain the same.

---

4. Amato Pietro Frutaz, ed., *Le Piante di Roma, vol II*. (Rome: Istituto di Studi Romani, 1962).





*Figure 3.7: Axial views from the top of the scalinata (top) and from the Fontana dei Tritoni (bottom). Compare to the eighteenth century views in Figure 6.11 and Figure 4.3 (Sardegna, 2002)*

Many pieces of Christina's collection of arts and antiquities are still present in the gardens today. Christina's two large marble bathtubs reside in the greenhouses, and now are filled with plants. When the statue of Cornelius was placed in the niche in the *prospettiva* after Fuga's work in 1741, an antique pedestal from Christina's collection was used as its base, and is still present in the niche today.

### 3.3 The Villa Corsini

The Riario palazzo and gardens were purchased by Cardinal Neri Corsini in 1736. Architect Ferdinando Fuga was hired by Corsini to oversee the renovation and expansion of the palazzo as well as the remodeling of the expansive gardens connected to the palazzo. A second ell was added to the palazzo, but the garden's axis remained as it was before the renovation: centered on the original palazzo, and in line with the *Prospettiva*. Nolli's map of 1748 (*Figure 3.5*) shows the expanded palazzo and the garden as they appeared before 1741 when the *scalinata* and the *Fontana dei Tritoni* were constructed.

Fuga reinforced the old axis with the addition of elements in line with the *prospettiva*. Several structures were constructed in the garden, including the *Fontana dei Tritoni* and the *Scalinata delle Undici Fontane*, a water-stair type fountain composed of a monumental staircase with a cascading fountain bisecting the uppermost portion (*Figure 3.6*).<sup>5</sup>

---

5. Vania Cutuli, L'intervento di Ferdinando Fuga nel Giardino di Palazzo Corsini a Roma, Alfonso Gambardella, ed., *Ferdinando Fuga: 1699-1999: Roma, Napoli, Palermo* (Napoli: Edizioni Scientifiche Italiane, 2001) p. 138.

The construction of the *scalinata* took place in 1741-2. Little was documented of the garden renovations; what is known has been gleaned from letters from Corsini and from notes and receipts from the workers and suppliers. No drawings of the water stair are extant,<sup>6</sup> although there are descriptions of the design and color scheme in correspondence. There is one drawing of the *prospettiva* by Fuga, titled “Fontana delle Prospettive” (*Figure 4.1*). It is unclear however whether this documented of the existing structure, or Fuga’s proposed changes, as it differs significantly from the structure that appears today. More than likely it is Fuga’s proposed design which was simplified in construction.

### **3.4 Orto Botanico**

The palazzo and part of the grounds were sold to the Italian state in 1872. The palazzo became the seat of the Accademia Nazionale dei Lincei, and was eventually made into a museum. The grounds on the upper part of the Janiculum hill were incorporated into a park which is managed by the state. The remainder of the grounds became the botanical gardens or Orto Botanico, managed by the University of Rome-La Sapienza. In the transformation from private garden to botanical garden, the emphasis shifted from the arrangement of the plants to the plants themselves. Significant changes were made to the garden’s layout in an effort to incorporate plant specimens according to scientific principles. The parterres disappeared, the central axis was disrupted, and the unimpeded axial view from the palazzo to the *prospettiva* obscured by a collection of palm trees (*Figure 3.7*). Today,

---

6. Enzo Borsellino, *Palazzo Corsini alla Lungara* (Rome: Schena Editore, 1988), p. 58.

the *prospettiva* and *scalinata* that were once a destination in the garden both visually and physically are more of a curiosity within the context of the botanical gardens.

## 4. ARCHITECTURAL STYLE

The architectural style of the *scalinata* and the *prospettiva* appear similar at first glance, yet while the *prospettiva* is a good example of a Renaissance nymphaeum, the water stair is a hybrid of classical nymphaeum design and baroque mannerism, blended to allow the two to coexist comfortably.

### 4.1 Nymphaeum

The nymphaeum is the result of an evolution of the grotto caves into an above ground temple celebrating water. The nymphaeum brings logic and order to the natural elements of the grotto, resulting in a structure that has a more regular, distinctly architectural form. Like grottoes, nymphaeum structures were constructed using many types of natural, water related materials: coral, river pebbles, and elements created by the slow sedimentation left by the trickle of water in natural grottoes. These rock formations, often called *spugne*<sup>1</sup>, were used to create texture and atmosphere within the formal architecture of the nymphaeum. As a representation of the forms created by water in grottoes, the *spugne* and coral are an important part of not only the visual reading of the structure, but also of its ideological meaning as well.

The grotto, and by extension the nymphaeum, are linked with the divine in many ways. The Renaissance brought with it a revival of the classics. Older architectural forms became popular again, and brought with them the mythologies from the Golden Age.

---

1. Philippe Morel, *Les Grottes maniéristes en Italie au XVI<sup>e</sup> siècle: Théâtre et alchimie de la nature* (Paris: Éditions Macula, 1998), p. 9.

Grottoes were a place that held the mysteries of the oracles. Visitors traveled great distances to receive divine knowledge through prophecy in mythic grottoes. The water which is so plentiful in the design of the nymphaeum brings with it the power of life and creation, as well as the destruction of the deluge<sup>2</sup>. The nymphaeum becomes a bridge between the real and supernatural worlds, and places the viewer within the world of classical myth.

The grotto also drew power from scientific beliefs of the time. Many in pre-1500 Europe believed that certain waters had the power to turn any object into stone<sup>3</sup>. This explained the creation of objects such as stalactites and coral. The inclusion of *spugne* type stone into grottoes and nymphaeum links the structure to the stone's magical beginning. This idea is also shown in the inclusion of statues of humans, animals, and mythical creatures such as nymphs, as if they had been ossified by the water.

As the grotto and nymphae forms regained popularity, the Catholic church also lent its symbolism to the form. Water became a purifying element as the symbol of baptism. This was at times taken to extremes in an attempt to completely subjugate the pagan nymph worship, and no pagan symbols would be used in the design.<sup>4</sup>

These ideas would have been easily accessible to viewers of the sixteenth and seventeenth centuries, creating a space which is both natural and intellectual. The nymphaeum is a

---

2. Philippe Morel, *Les Grottes maniéristes en Italie au XVI<sup>e</sup> siècle: Théâtre et alchimie de la nature* (Paris: Éditions Macula, 1998), p. 94.

3. Ibid., pp. 57-58.

4. Naomi Miller, *Heavenly Caves* (New York: George Braziller, Inc., 1982), p. 42.

place where the human viewer could interact with science and nature, the ethereal and worldly, all at once.

In a time where classical architecture was once again valued, the nyphaeum was a portrayal of a new golden age. In earlier times, the grotto was a place of knowledge and oracle, but also a place to be enjoyed. It was a place of repose where visitors could enjoy the soothing sounds of the water. In the summer, the cooling effect of the water and the shade of the structures and foliage abated the heat. The nyphaeum structures built in the sixteenth and seventeenth centuries incorporated these ideas, but in a way that subjugated nature to man's will. Nature was imitated and improved upon using elaborate hydraulic systems. It was given a form incorporating reason in the regularity of the architecture. This imitation nature was utilized as a component of human art forms, not as beautiful in and of itself.

Elaborate use of hydraulic systems can be seen in many gardens created in the sixteenth and seventeenth centuries in Italy. Like the architecture of this time, the gardens were influenced by classical design ideals, drawing inspiration from literature and design treatises<sup>5</sup>. These gardens were usually a mix of classical architecture, water elements, and formal gardens, including intricately designed hedges and parterres.

The gardens at the Villa d'Este in Tivoli were designed to showcase the plentiful waters from the acqua Aniene.<sup>6</sup> Cardinal Ippolito d'Este planned the garden in the mid-sixteenth

---

5. University of Pennsylvania, *The Orto Botanico and the Scala d'Acqua of Rome*, 2002, available at: <http://www.design.upenn.edu/hspv/rome/>, p. 11.

century to be a pleasant retreat during the summer, and used the water and greenery in ways that utilize their cooling qualities. The many fountains are organized along axes that run in directions perpendicular and parallel to the palazzo to take full advantage of the garden's terrain. Their styles are numerous, ranging from large sprays in the *Fontana dei Draghi* to a gentle cascade in the water stair style *Scala dei Bollori*. The cooling effect of the water is heightened by the shade created by the architecture and the numerous hedges and trees.

In the mid-sixteenth century, the Farnese family renovated a large fortress in Caprarola, including the design of a large garden. The formal gardens at the Villa Farnese are arranged along a central axis, and as in the Villa d'Este, water has a strong presence in the design. There are nymphaeum type structures and a water stair along the axis leading to a belvedere. Water also takes an interactive role in this garden: there are spouts in unexpected places which could be turned on to startle the visitors.

In these and many other examples of gardens in Italy during the sixteenth and seventeenth centuries, nature was harnessed for human beings' delight. It was cooling during the summer, a pleasant sound away from the noise of the city, and a cornucopia of pleasing views placed so as to be easily accessed. Nature became the proscenium in outdoor theaters, and the frame for beautiful architecture.

---

6. Isabella Barisi, "Il disegno del giardino e l'architettura vegetale," *Villa D'Este* (Rome: De Luca Editori D'Arte S.r.l., 2003) p. 55.



## 4.2 Ferdinando Fuga

Architect Ferdinando Fuga was born in Florence in 1699, and remained there for the early part of his life. He studied the basics of architecture there under G.B. Foggini. Fuga moved to Rome in 1717, where his design skills matured beyond the Baroque design tenets that he strictly adhered to early in his career.<sup>7</sup>

Fuga came to Rome during an era rife with intellectual upheaval. The followers of Borromini and Bernini were at odds with each other over the design of several new monuments in Rome. The election of Pope Clemente XII Corsini caused a revisiting of classical Roman arts. Clemente XII and his entourage, which included Neri Corsini, exerted their influence to cause a renewed interest in antiquities. A surge in restorations, new structures incorporating classical style, and interests in collecting antiquities followed.<sup>8</sup>

Fuga brought a more rational Baroque style to Rome. His style was more mannerist, still influenced by Bernini and Borromini, but drawing inspiration from the forms of classic architecture. Fuga believed that the shortcomings of Baroque design could be mitigated by neoclassicism<sup>9</sup>.

Many of his later works built upon preexisting structures, requiring him to incorporate another architect's style into his additions to the building. Fuga did not copy the existing

---

7. Enzo Borsellino, *Palazzo Corsini alla Lungara* (Rome: Schena Editore, 1988), pp. 97-98.

8. *Ibid.*, p. 93-94.

9. *Ibid.*, p. 97.

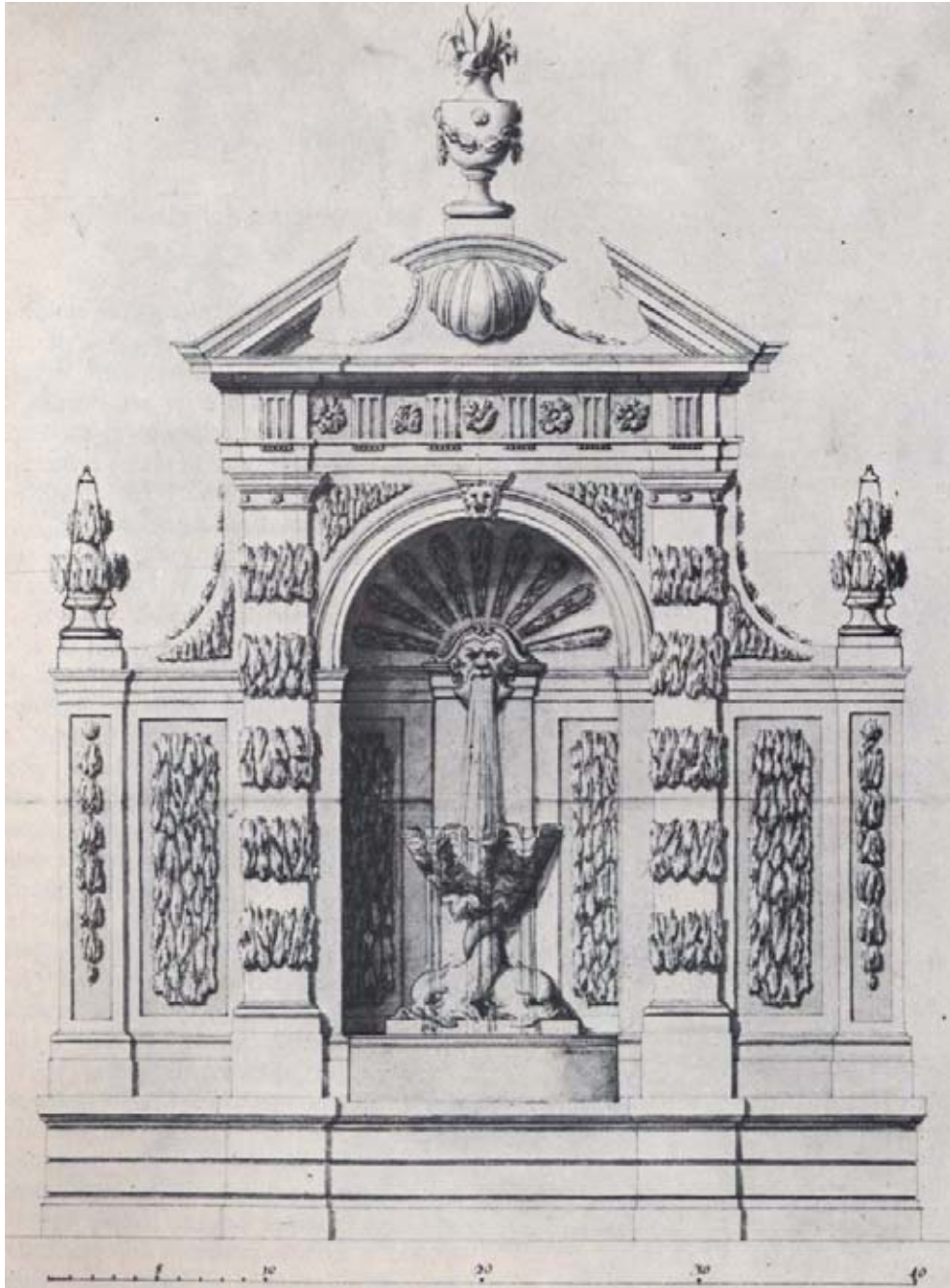
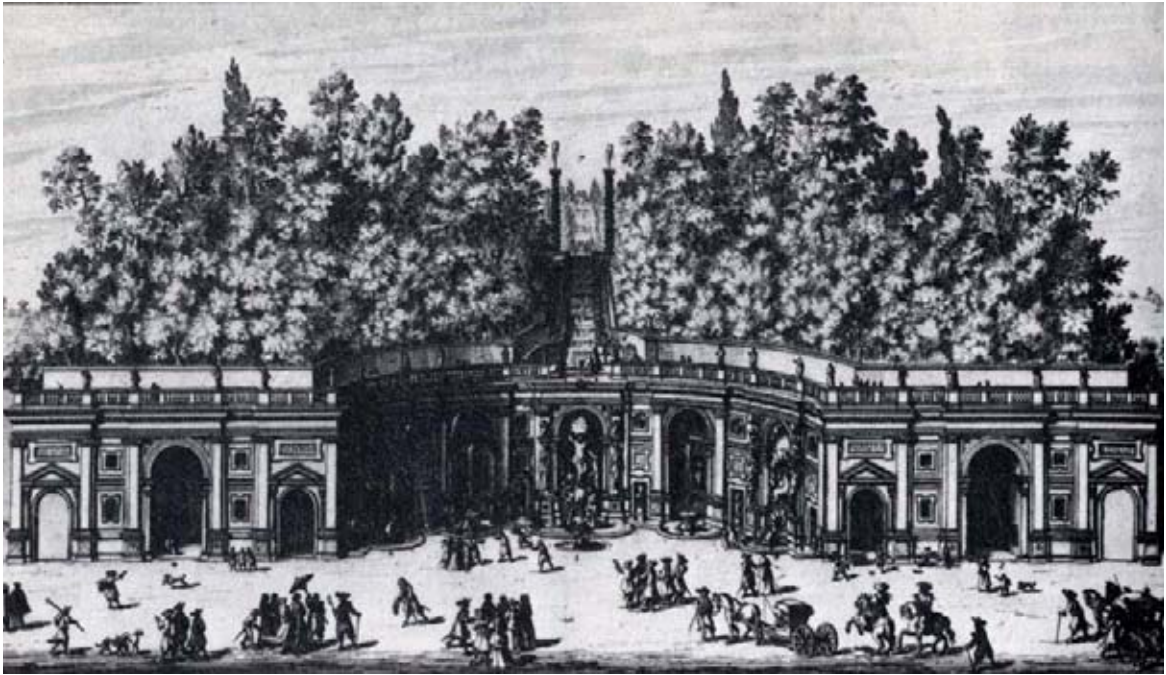

Figure 4.1: Fuga's drawing of the "Fontana delle Prospettive."  
The fountain was never built. (Kieven, *Ferdinando Fuga e l'Architettura Romana del Settecento*, p. 30)



*Figure 4.2: The water stair and nymphaeum at Villa Aldobrandini  
(Blunt, Guide to Baroque Rome, p. 266)*

style exactly, but instead in each case, he would use the rhythm of the elements to create an addition which was a fusion of baroque and classical elements. Probably the best known example of this type of Fuga's work is Santa Maria Maggiore church in Rome. Fuga designed a new facade and restored the interior of the church. In both the restoration and the new construction, he took his cue from the existing fifteenth century structure, creating elements that had a baroque flavor but coexisted peacefully with the older elements.

#### **4.3 The Prospettiva (Nicchione)**

The *prospettiva* is a nymphae type structure, probably originally built to mark a spring on the site. Natural springs dot the hillside above the Palazzo Corsini, and it is likely that one

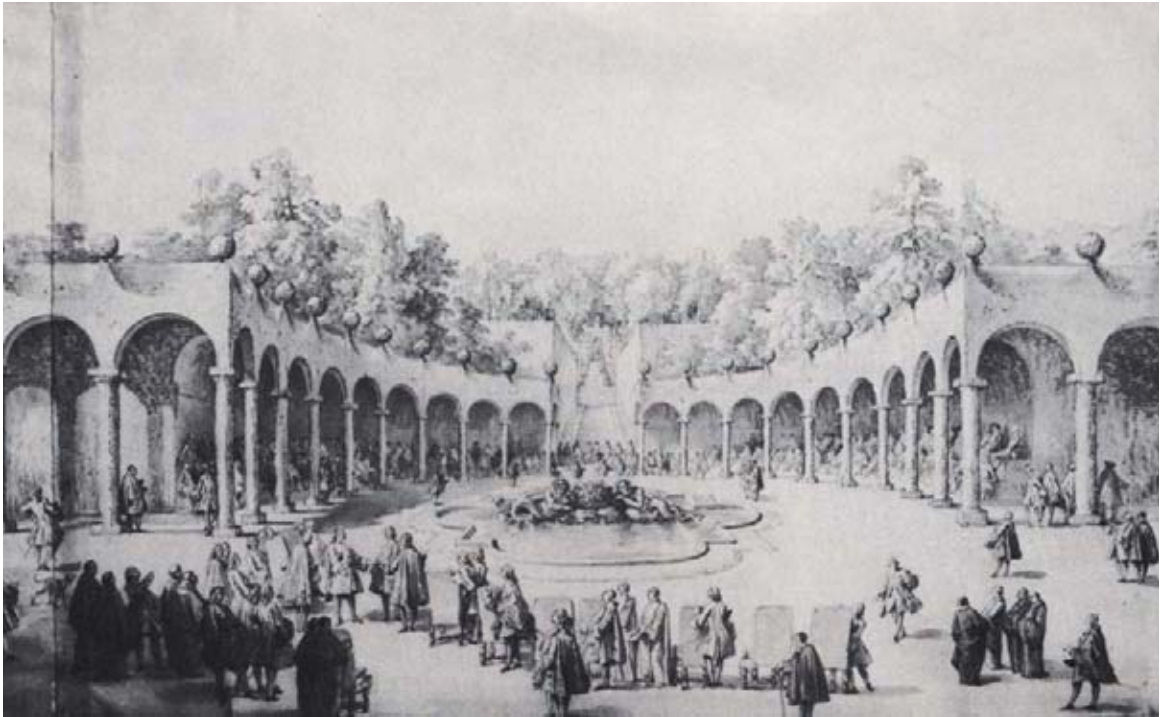

Figure 4.3: View of the “green theater” setting created by Fuga (Kieven, *Ferdinando Fuga e l’Architettura Romana del Settecento*, p. 231.)

existed at the site of the *prospettiva*<sup>10</sup>. Its form is heavy and massive, with multi panelled walls flanking a large niche and supporting a large broken pediment. The internal structure is brick with lime mortar joints. The finish elements are moulded in lime plaster. Much of the decoration has deteriorated, so many of the stucco elements described in historic texts or shown in drawings such as the “*rosoni*”<sup>11</sup> and urns are not evident. It has a rusticated finish, incorporating fields of *spugne* type stone within smooth plaster frames. Shell motifs can be found in the ornamentations and in the shape of the half dome of the niche. Texts and a drawing from Fuga’s renovation suggest that a fountain was to be constructed in the renovation (*Figure 4.1*). The fountain and the grotesques were not built. Instead of a

---

10. Lecture by and discussion with Leo Lombardi, July 7, 2003.

11. Enzo Borsellino, *Palazzo Corsini alla Lungara* (Rome: Schena Editore, 1988), p. 61.

fountain, a Roman pedestal and a statue of Cornelius Corsini occupied the niche after the work of 1741.

Maps predating 1741 show the footprint of the *prospettiva* as much larger than it is currently. This suggests that it was formerly a nymphaeum with flanking rooms, typical of the style popular in the Renaissance. Since Corsini wanted to retain as much of the historic fabric as possible<sup>12</sup>, it is likely that these structures had been damaged beyond repair before the time of the renovation. No part of them remains above ground.

#### **4.4 Scalinata delle Undici Fontane**

The style of the *scalinata*'s upper section mimics that of the *prospettiva*. This section is a mannerist nymphaeum, and water related imagery is utilized here in a way reminiscent of the *prospettiva*. The large retaining walls are composed of large panels textured with *spugne* type stone similar to that used in the *prospettiva*. The spring, and probably the unbuilt fountain, of the *prospettiva* is mirrored in the five tiered fountain that bisects the upper stair. Shell motifs are found in the shape of the basins, and a shell formerly adorned the apex of the fountain. The uppermost spout of the fountain originally had the shape of a dolphin. Fuga incorporated these elements without creating a strict nymphaeum, but the resulting structure exists harmoniously with the *prospettiva*.

---

12. Enzo Borsellino, *Palazzo Corsini alla Lungara* (Rome: Schena Editore, 1988), p. 101.



*Figure 4.4: An example of travertine and cortina finishes used on the Capitoline Palaces, and a detail of the cortina finish (Sardegna, 2004)*

In the upper section, Fuga marries the nymphaeum style to baroque sensibilities. As with his other later projects, Fuga takes the feel of the elements of the existing and incorporates this into a logical addition. The design of the *Scalinata delle Undici Fontane* was most

likely influenced by designs of the preceding century, such as the *Scala dei Brollori* at the Villa d'Este in Tivoli, and the Villa Aldobrandini del Belvedere in Frascati<sup>13</sup> (*Figure 4.2*). This type of structure lends itself well to the fashion of the melding of nymphaeum and theater in the Baroque era. Corsini wanted a theatrical setting in his garden, called a “Teatro della Verdura” (green theater) in correspondence<sup>14</sup>, that incorporated many of the new elements designed by Fuga. This concept was emphasized by the construction of a foliage arcade around the *Fontana dei Tritoni*, that framed the water stair high above on the slope beyond (*Figure 4.3*).

Like the *prospettiva*, the *scalinata* is constructed of bricks with lime mortar, but its construction differs in the use of large travertine elements which have not been carved. These large blocks are used in key structural locations, such as the bases and caps of the walls, and the large stair treads. They are not ornate, as is the top of the *prospettiva*. The ornamentation came from terra cotta planters, travertine urns, and marble busts, which were placed along the top of the walls and on each level of the fountain.<sup>15</sup>

On the upper panels, Fuga used a palette that was popular in Rome during that time. As in the lower panels, the frame elements were painted to mimic travertine. The inner panels were painted a cortina color, in imitation of fine Roman brickwork.<sup>16</sup> Similar designs were used in earlier structures in Rome such as the *Scala d'España* and the *Capitoline Palaces* (*Figure 4.5*).

---

13. Enzo Borsellino, *Palazzo Corsini alla Lungara* (Rome: Schena Editore, 1988), p. 59.

14. *ibid.*, pp. 56-57.

15. *Ibid.*, p. 239.

16. *Ibid.*, p. 58.

The fronts of the large retaining walls that flank the *scalinata* contain two rondels that contain remnants of sgraffito. The design appears to be a cream colored floral motif on a purple background. The sgraffito is incongruous in a nymphaeum setting. This type of decoration would have more likely been created using a mosaic of pebbles or shells. Excavations at the top of the stair have found a pavement of river stones, yet the fussiness of a pebble mosaic does not fit with the unadorned nature of Fuga's design and probably dates to the earlier design. The sgraffito is most likely a later nineteenth century addition.

Flanking the level below the *water stair* are retaining walls which appear to be remnants of the previous structure. They are constructed of large irregular stones with exposed mortar joints, and the walls are topped with a brick cap. They appear to have been part of an older grotto structure perhaps as seen in the DuPerac and Paoli views of the late sixteenth and early seventeenth centuries. Little of the finish elements survive. A large *spugne* outcropping remains on the south wall. There are openings in the walls that could have either been drains or sources of water for spouts. As with the *prospettiva*, it is likely that this structure was damaged before the construction began given Corsini's desire to preserve the older structures.

The lower sections connect the nymphae type structures with the palazzo both physically and stylistically. They continue the rhythm of the *scalinata*, but none of the panels are textured with *spugne* stone. The coloring of the panels is the same as the upper panels of the large retaining walls adjacent to the *scalinata*. Their style is further simplified, with no



ornamentation other than simple urns topping the pilasters. The simplicity of the palazzo and its fence is subtly mimicked in the rails.

## 5. FINISH ANALYSIS

For purposes of analysis, the finish samples from the *scalinata* are separated in three categories: those from frame elements, those from untextured panel elements, and those from pilasters or other decorative elements. The finish samples from the *prospettiva* are only from frame elements or pilasters due to restricted access. These samples were mounted and cross sectioned to view the substrate and finish layers. The cross sections were viewed and photographed using reflected normal and ultra-violet light under 25x magnification. See Appendix A for sample schedule and Appendix B for analysis.

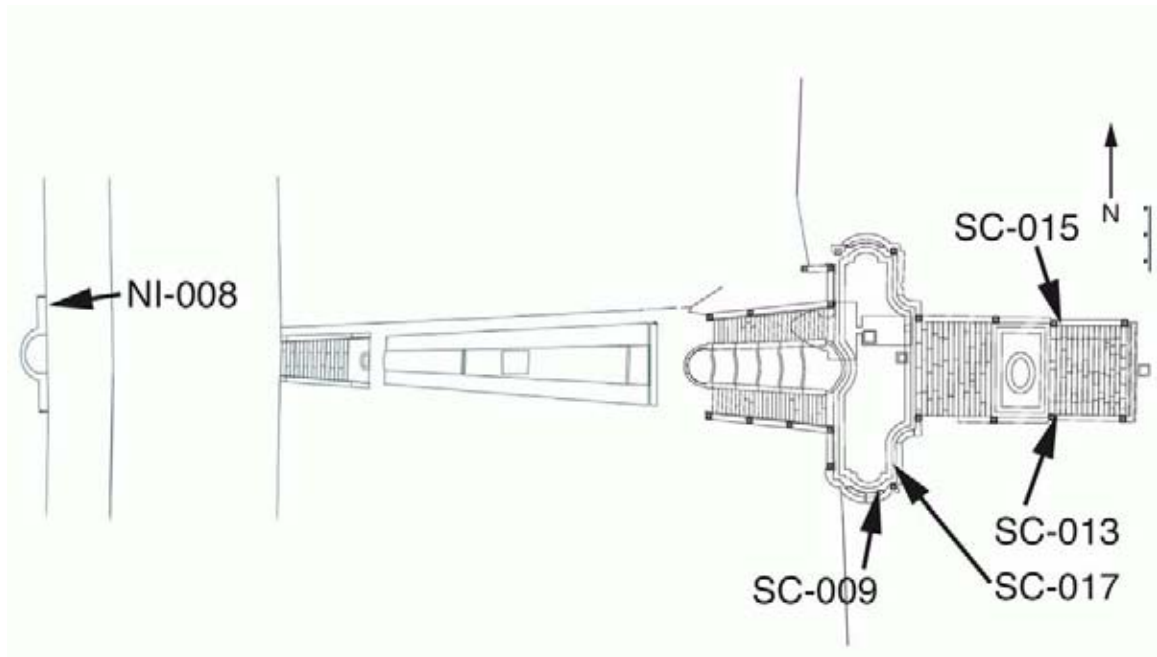
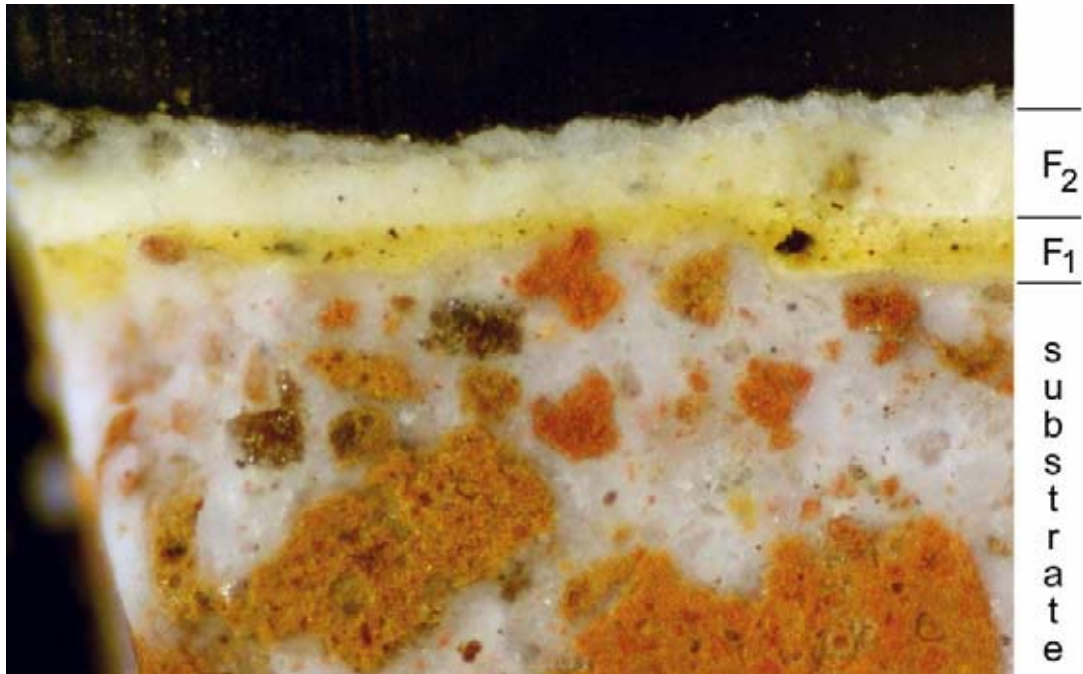

Figure 5.1: Locations of samples exhibiting travertine colored limewash

### 5.1 Travertine color

Surfaces decorated with a travertine color finish typically have layers varying in color from pale cream to yellow. The variations in color are used to mimic the natural coloration of travertine stone. The travertine finish gives the appearance of stone and corresponds to those areas where stone is used for structural reasons, such as the foundation and cap elements. Much of the *scalinata* plaster would have been painted a travertine color. This color was found on samples from frame elements, pilasters, and most flat surfaces. All early finishes appear to be limewashes.



*Figure 5.2: An example of the yellow and cream travertine color from a decorative element (SC-009 at 25x magnification)*

SC-009 (*Figure 5.2*)

This sample was collected in an area sheltered by a stone bench on the south portion of the terrace below the water stair. This is from a flat area that did not have framed elements and that would have most likely been travertine colored at the time of construction. There are three extant finish layers: one yellow and two pale cream limewash layers. All appear to have been applied as one campaign and probably date to the eighteenth century.

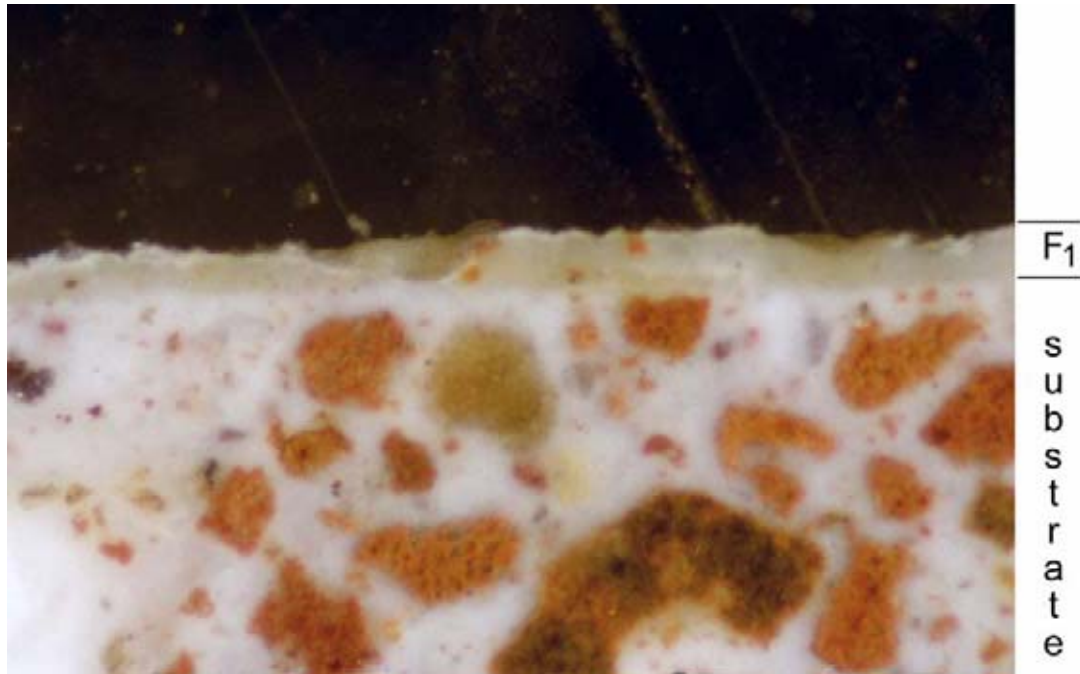
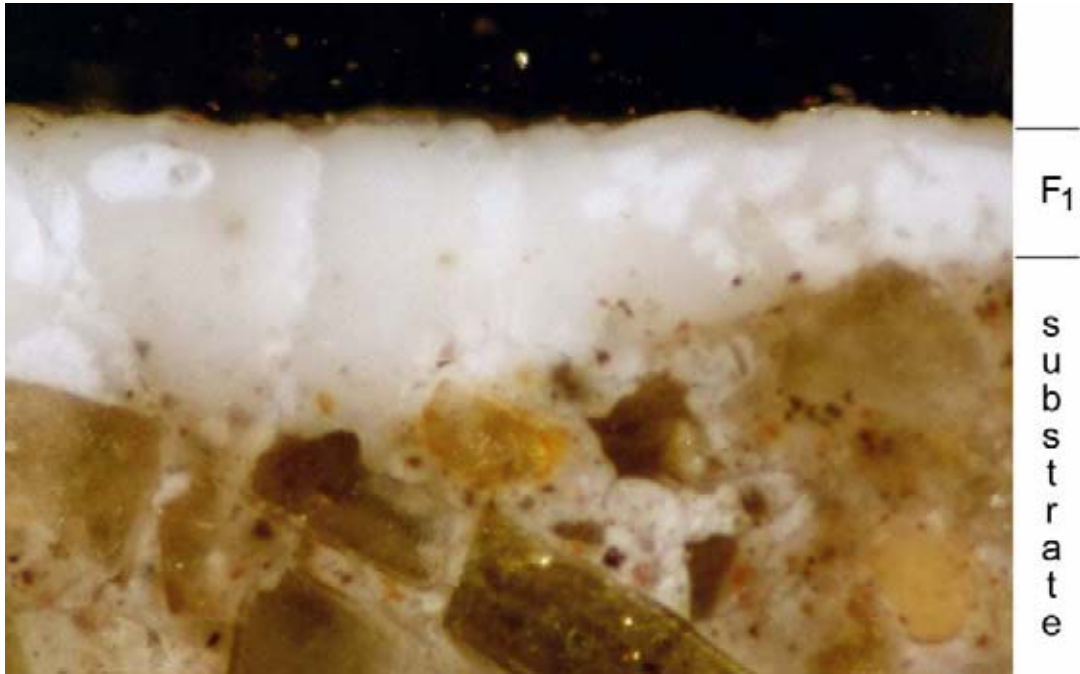

*Figure 5.3: An example of cream travertine color from a frame element (SC-013 at 25x magnification)*

SC-013 (*Figure 5.3*)

This sample was collected on the frame of a panel on the south wall of the lower stair. This area was probably travertine colored at the time of construction. There is one layer of creamy white limewash extant. The area of the sample was mottled with two similar colors which may have been used to create a travertine finish.

The plaster substrate is typical of many of the samples. It is composed of a white lime matrix with pozzolana aggregate. There is finer pozzolana near the top of the plaster layer.

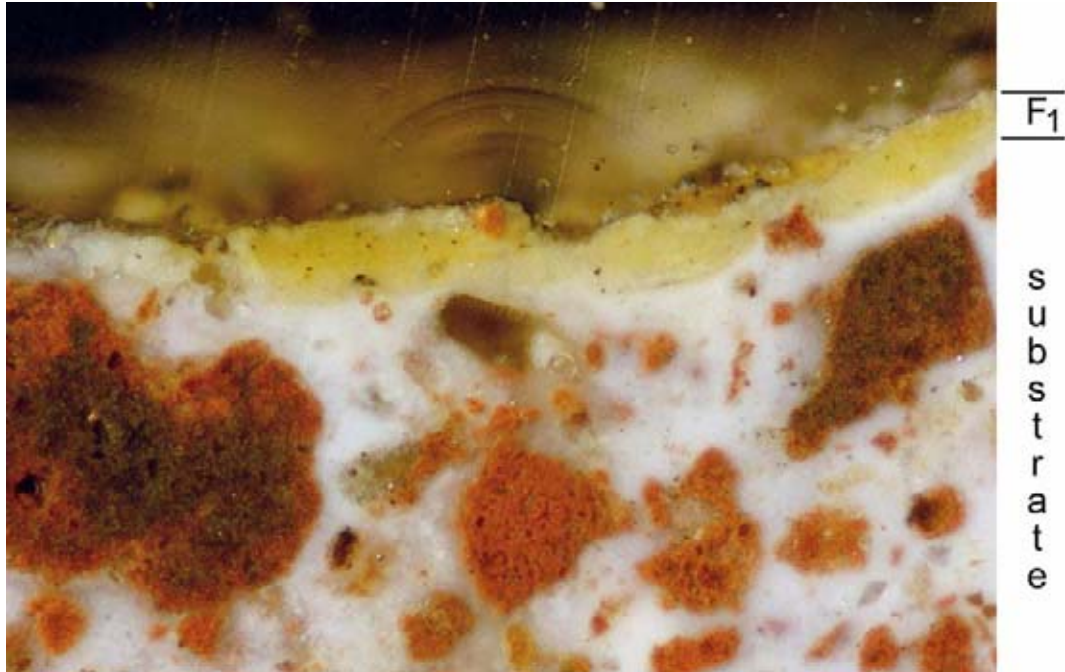

*Figure 5.4: An example of a modern repair of a light colored area (Sample SC-015 at 25x magnification)*

SC-015 (*Figure 5.4*)

This sample was collected from a pilaster on the north wall of the lower stair. This area may have been travertine colored at the time of construction. This sample appears to be a repair to the stair and has a very different appearance. The single limewash layer is very thick and white, and its constituents are more uniformly ground. In UV light, it fluoresces evenly, with no visible pigment particles.

The plaster differs substantially from most of the other samples in both its aggregate and matrix. Instead of pozzolana, the aggregate is composed primarily of sharp translucent particles. The matrix to aggregate ratio is much lower, and the matrix does not fluoresce as brightly under UV light.



*Figure 5.5: An example of the yellow and cream travertine color from a frame element (Sample SC-017 at 25x magnification)*

SC-017 (*Figure 5.5*)

This sample was also collected from the south portion of the terrace, from a frame element. This area would have been travertine colored at the time of construction. There is one mottled yellow and cream limewash layer remaining which appears to be original. The plaster is typical, composed of pozzolana aggregate and a white lime matrix.

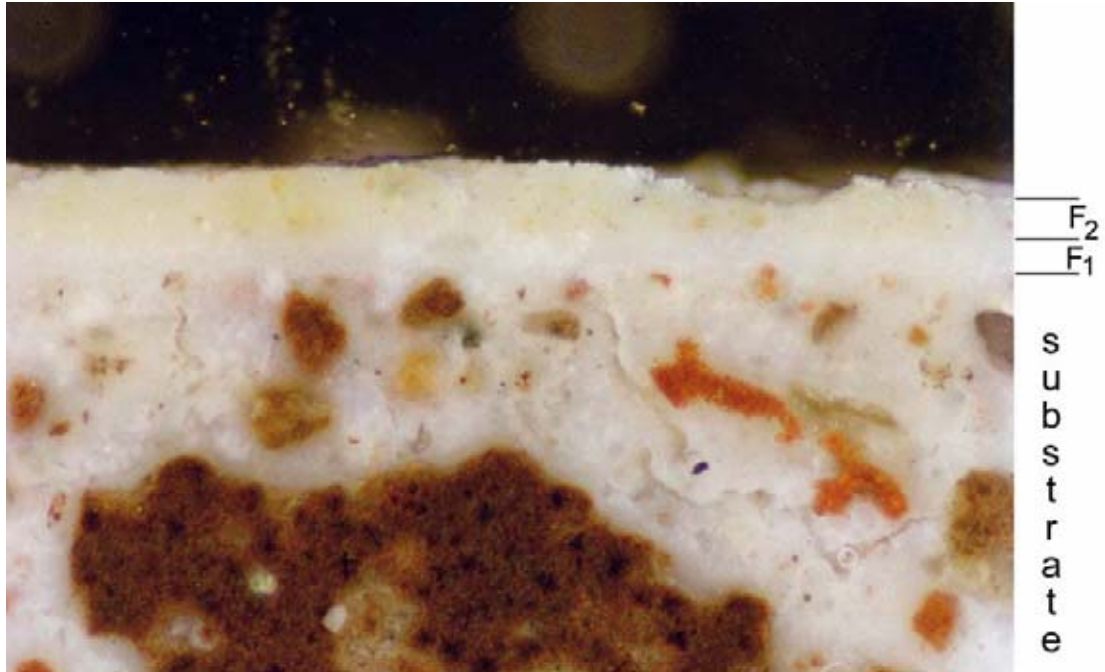

*Figure 5.6: An example of and cream travertine color from a *prospettiva* frame element (Sample NI-008 at 25x magnification)*

NI-008 (*Figure 5.6*)

This sample was collected from the frame of the northmost panel of the *prospettiva*. There are no records of the original color scheme of this structure, but it is likely that its heavy form would have been painted a travertine color to portray the implied monumentality of the structure. There are two cream limewash layers, that both appear to be original. The plaster substrate is similar to those found in many of the *scalinata* samples. It is a white lime matrix with pozzolana aggregate.



## 5.2 Cortina color

Surfaces decorated with a cortina color generally have layers varying from pink to pink-orange. Like the travertine finish, the cortina coloration is used to mimic a masonry material, in this case fine brickwork. The cortina color was used as a contrasting color in the central fields within the frame elements. It was found in other areas as well, which brings into question the areas which may have originally been cortina colored.

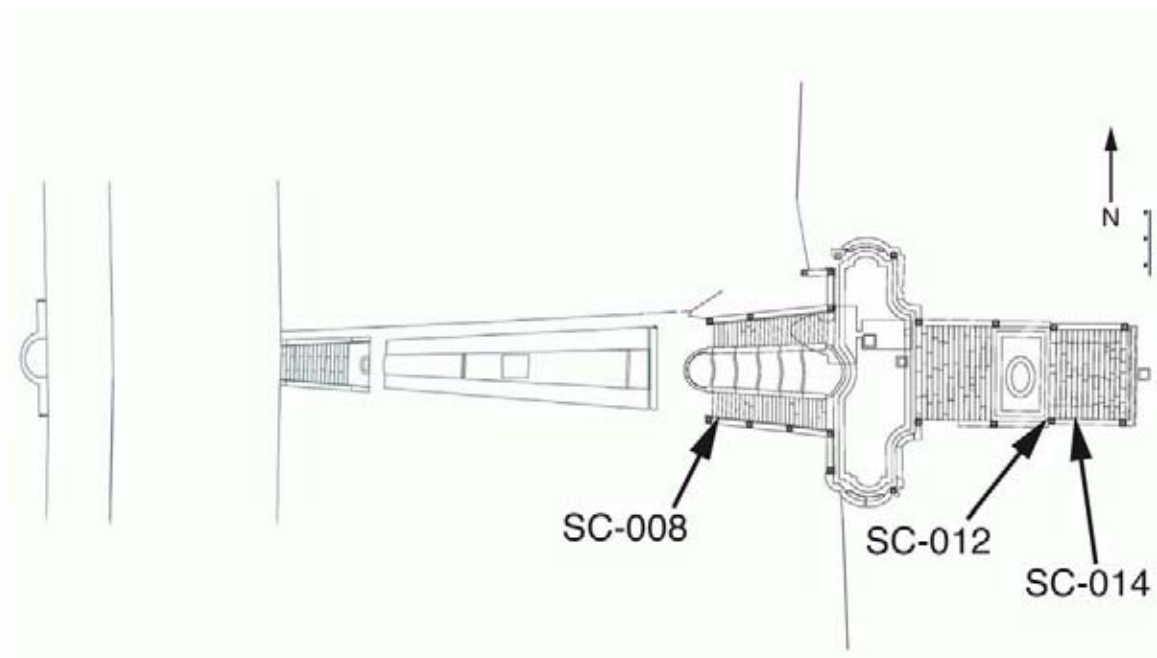

*Figure 5.7:* Locations of samples with cortina colored limewash layers.

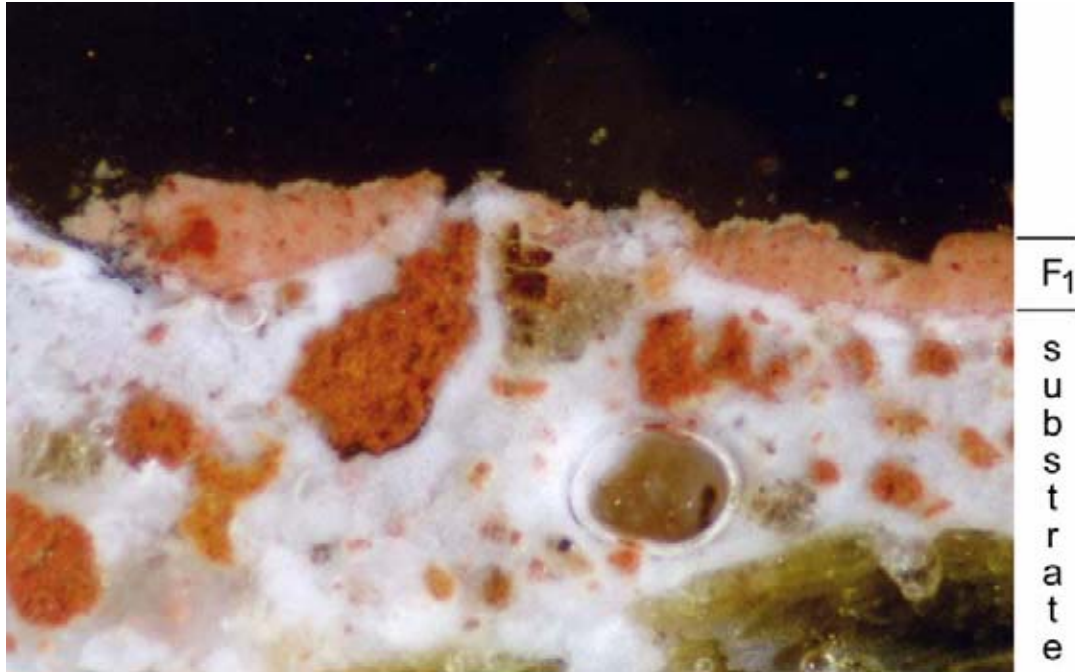
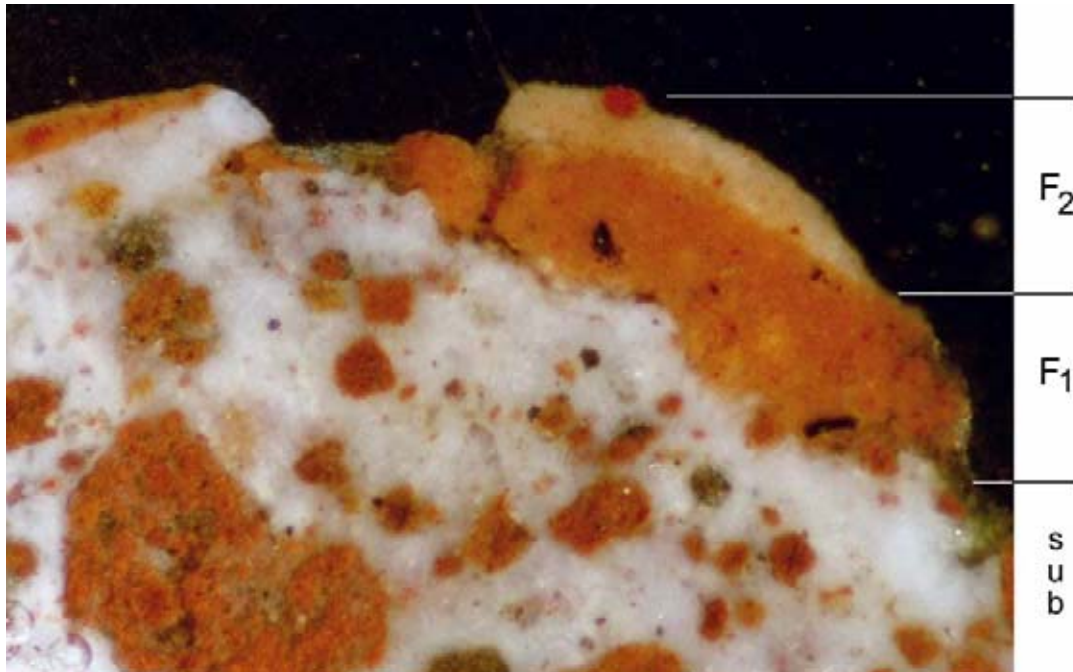

*Figure 5.8: An example of the pink cortina color from an interior field (Sample SC-008 at 25x magnification)*

SC-008 (*Figure 5.8*)

This sample was collected from the interior field of the southwest-most upper panel on water stair. There is one layer colored, which appears to be a pinkish limewash finish with dark reddish pink pigment agglomerants. This area was probably cortina colored at time of construction.

The plaster substrate is composed of a white lime matrix and pozzolana aggregate similar to other samples.

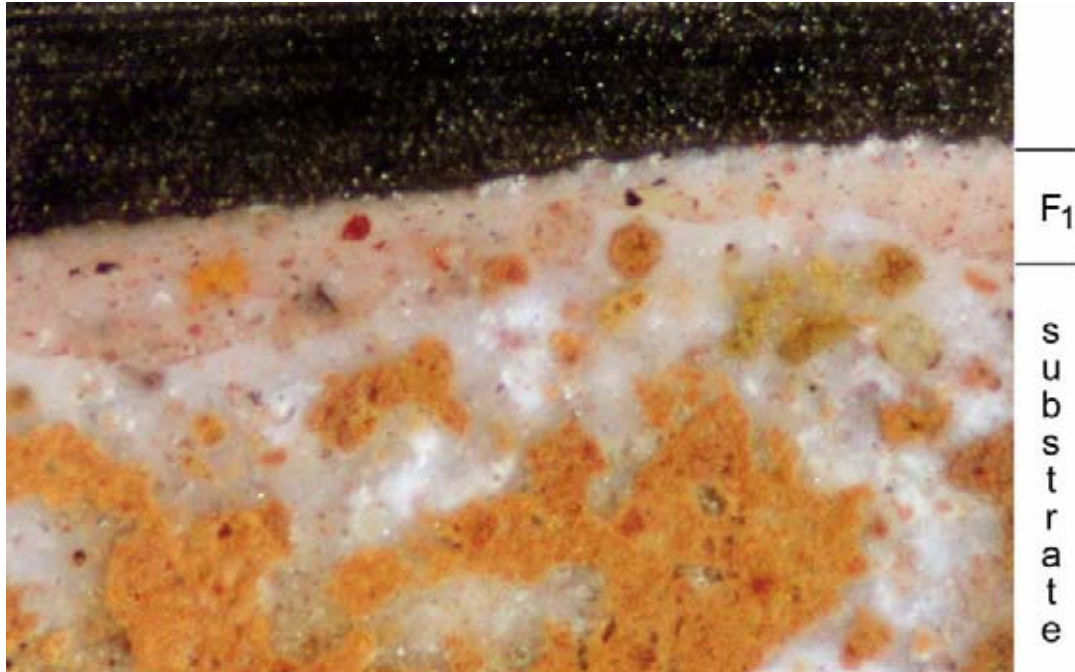

*Figure 5.9: An anomalous example of brick colored finish from a pilaster (Sample SC-012 at 25x magnification)*

SC-012 (*Figure 5.9*)

This sample was collected on a pilaster on the south wall of the lower stair. There are two finish layers: one orange (F<sub>1</sub>) and one pink (F<sub>2</sub>). This would not be remarkable if it were present in a central field, but as it was found on a pilaster in the lower part of the stair, where one might expect a creamy white travertine color, it presents an alternate color scheme. This sample was hidden under a coat of plaster, perhaps from a repair in recent years, that protected the older finish (*Figure 5.13*).

The plaster substrate is composed of a white lime matrix with pozzolana aggregate, typical of many of the samples. The plaster of the repair layer is similar to other more recent plaster.



*Figure 5.10: An example of the pink cortina color from an interior field element (Sample SC-014 at 25x magnification)*

SC-014 (*Figure 5.10*)

This sample was collected from an interior field on the south wall of the lower stair. There is one extant limewash layer, which is pale pink in color with a coarsely ground pigment. This area was probably cortina at time of construction.

The plaster substrate is slightly different from the typical plaster. It exhibits a white lime matrix with courser, pale pozzolana aggregate. There is a greater density of pozzolana in this plaster.



*Figure 5.11: Watercolor depicting the top of the scalinata, 1780 (University of Pennsylvania, *The Orto Botanico and the Scala d'Acqua of Rome*, 2002, p. 37.)*

These three samples are different in color and composition, suggesting different finish campaigns.

Finish stratigraphies suggest that the appearance of the water stair has changed little over time. Many of the samples have few layers; most surfaces are devoid of finishes from weathering. Most of those samples that have retained finishes have one to three layers, and are consistent with Fuga's color specifications<sup>1</sup>. These samples therefore appear to exhibit the original finishes. The color scheme is are consistent with paintings, and period photo-

graphs that exhibit tonal differences that correspond to the lighter travertine and the darker cortina.

The appearance of the pink and orange colors in Sample SC-012 on the pilaster suggests that the pilasters were originally colored cortina. This color placement is supported by the coloration in a watercolor dated 1780, soon after the water stair was constructed (*Figure 5.11*). The pilasters visible at the top of the water stair are a mottled pink, a similar color to the interior fields and a darker color than the neighboring frames. The two colors found in Sample SC-012 could be used to create this mottled appearance. These two colors are similar to the colors found during the survey of the faades of the Capitoline Palaces in the areas which were originally cortina.<sup>2</sup>

An illustration dated 1867 shows the pilasters as being a pale color which starkly contrasts the interior fields within the frames (*Figure 5.12*). This suggests that the coloring of samples SC-015 and SC-019 had replaced the cortina coloring by this point. SC-015 appears more modern: the paint layer is very thick, and the mortar has a unique appearance. The mortar contains primarily quartz sand in the paste. SC-019 may be much older. The paint layer is much thinner, and the mortar is similar to many of the other samples. The mortar contains a large amount of pozzolana rather than quartz sand.

- 
1. The colors used for the finishes, “color di travertino” and “color di cortina,” are described in original documents. See: Enzo Borsellino, *Palazzo Corsini alla Lungara* (Rome: Schena Editore, 1988), p. 58, footnote 10.
  2. N. Berlucchi and R. Ginanni Corradini, *Diagnostic Surveys of the Façades of the Capitoline Palaces in Rome: A Contribution to Knowledge and to Methods of Restoration*, available at: <http://www.unesco.org/archi2000/pdf/berlucchi.pdf>

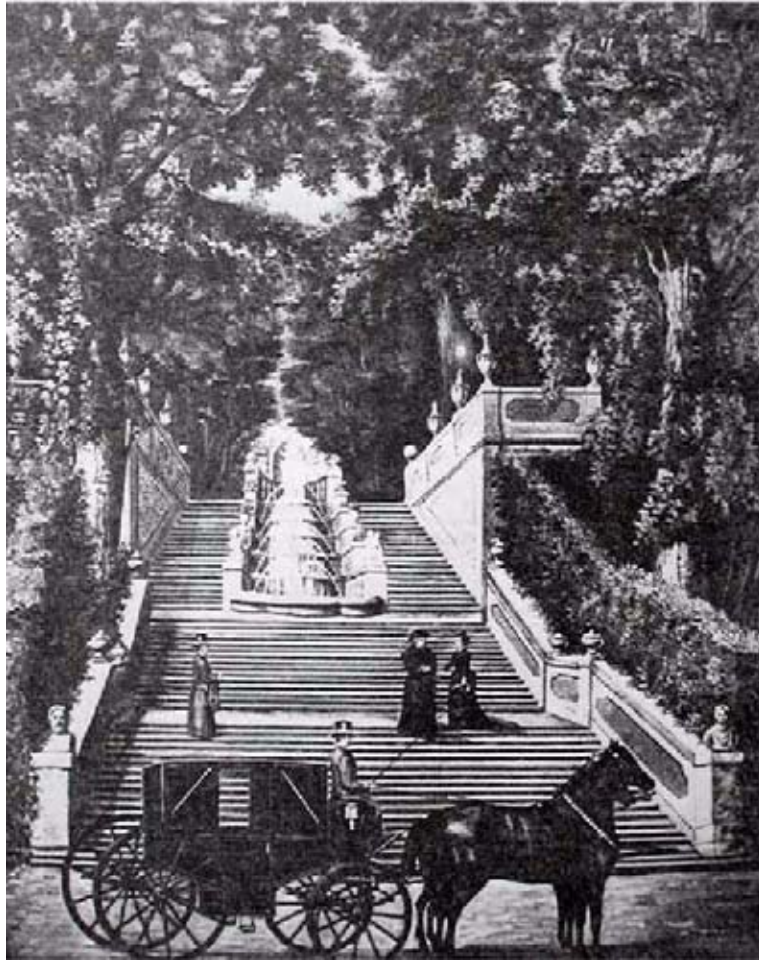

*Figure 5.12: Water color depicting the scalinata, 1867  
(Borsellino, Palazzo Corsini alla Lungara, p.328)*

The interior fields appear to have been consistently colored a cortina-like color. Where a finish layer exists in these areas, it is inevitably a pink color. This is consistent with period illustrations. Many of the interior panels were originally finished with a rough texture, contrasting with the smoother finished frames. Later repairs ignored this textural difference.



*Figure 5.13:* Exposed site of sample SC-012. The grey field below the exposed orange finish plaster appears to be a more recent repair.

The *prospettiva* has similarly changed little over the last two centuries. The cross sections show few layers of finish. It appears that the plaster was finished to imitate travertine throughout its existence. Some darker taupe colors appear in the niche, but these seem to be the result of fire damage rather than an intentional color.

A complete list of the samples and their analyses can be found in Appendix A.



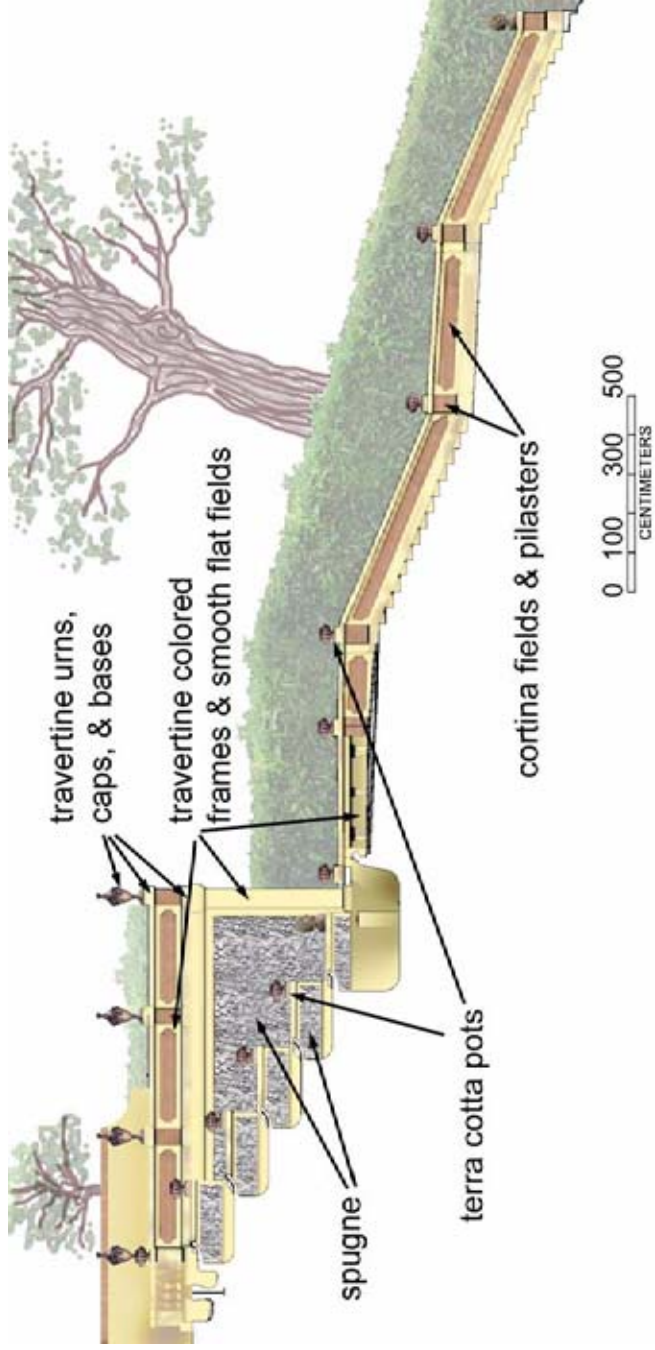

Figure 5.14: Theoretical eighteenth century finish scheme.

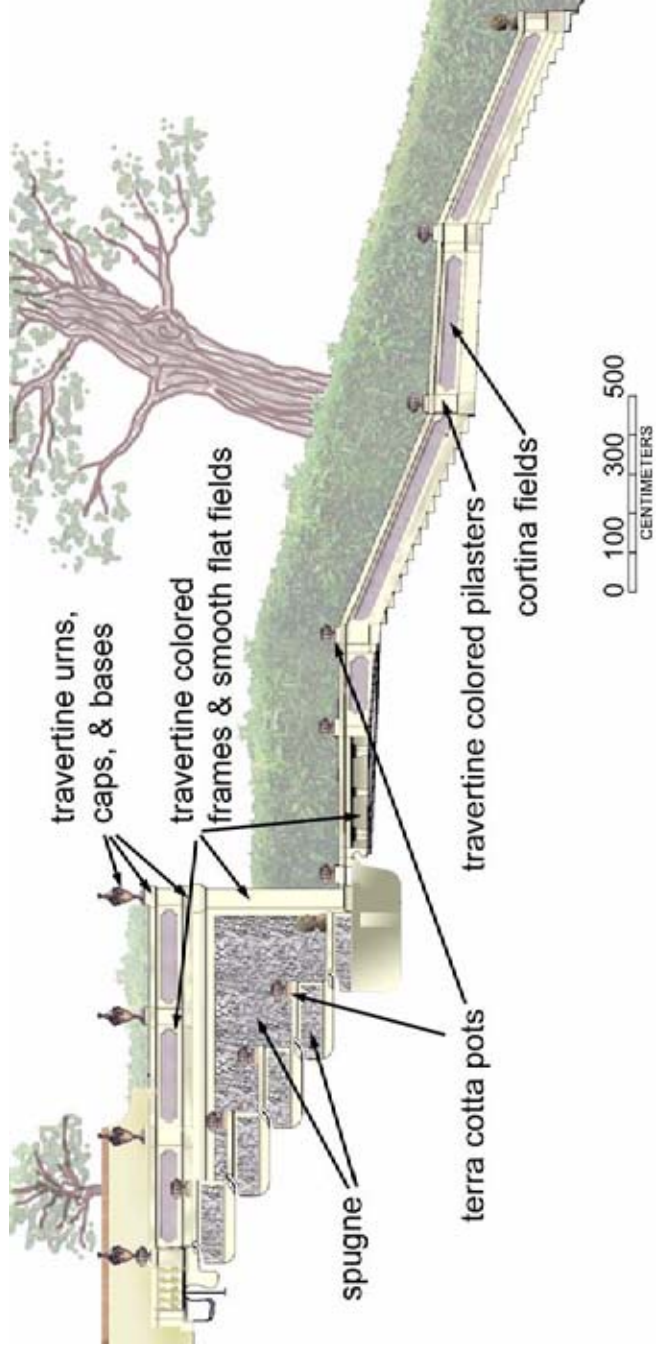

Figure 5.15: Theoretical nineteenth century finish scheme.

## 6. MORTAR ANALYSIS

Five mortar samples were selected and prepared as thin sections. These samples were collected in areas thought to date from different building episodes: the north wall of the *scalinata*, the old south wall near the *scalinata*, the old south wall near the *spugne* outcropping, the old north wall, and the *prospettiva*. The thin sections were examined under reflected and transmitted light at 25x magnification.

All of the thin sections were dyed on one half of the slide for  $\text{CaCO}_3$ . Each of the following samples showed positive staining of the matrix indicating a lime-based paste.

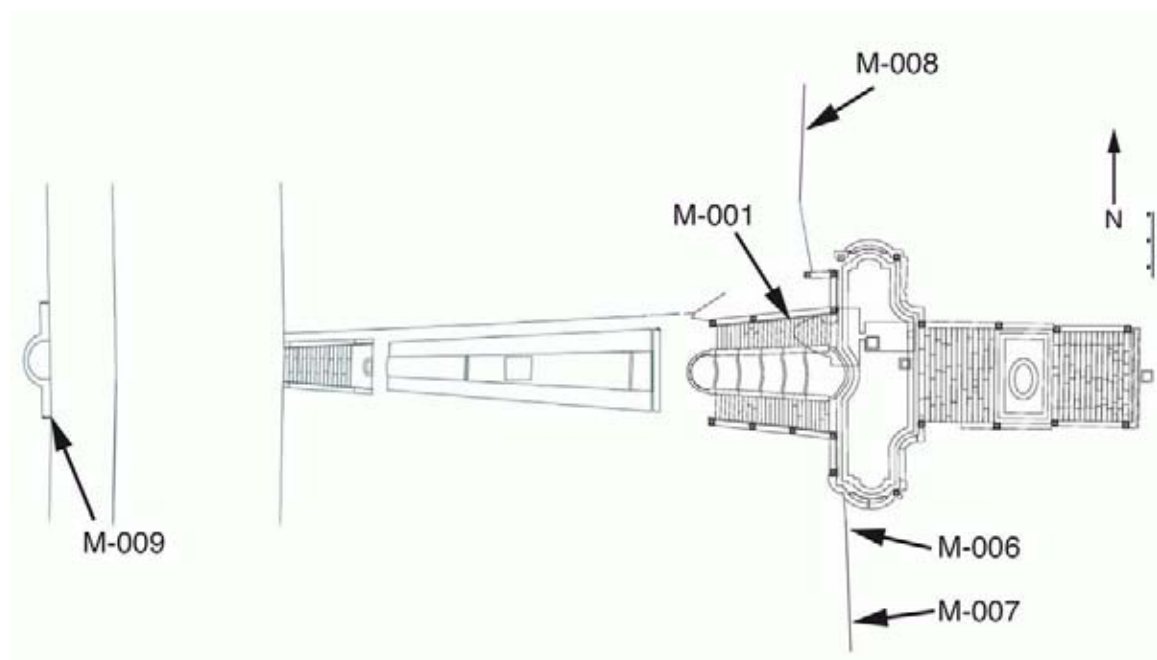
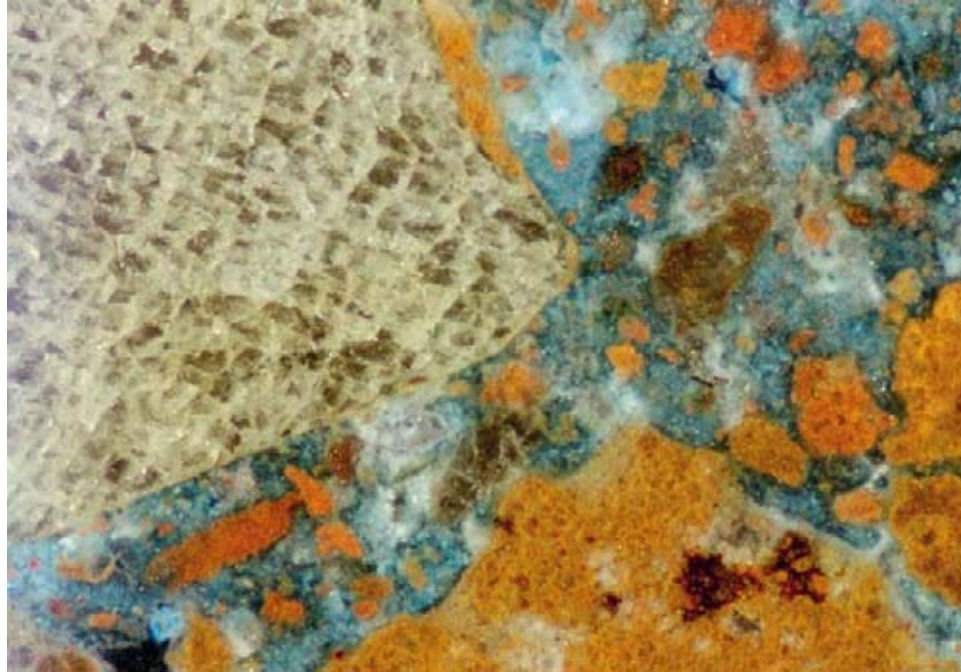

Figure 6.1: Locations of the samples chosen for mortar analysis.



*Figure 6.2: Sample M-001 (25x magnification)*

Sample M-001 (*Figure 6.2*)

This mortar sample was collected from between bricks in an area where the plaster and *spugne* finish is missing on the north *scalinata* wall. This area was chosen because it is likely to be representative of the mortar used during the construction of the *scalinata* in 1741. The matrix is light cream in color and stains positive for  $\text{CaCO}_3$  suggesting a lime putty paste. The aggregate contains: fine pozzolana, and both fine and coarse white translucent sand particles.

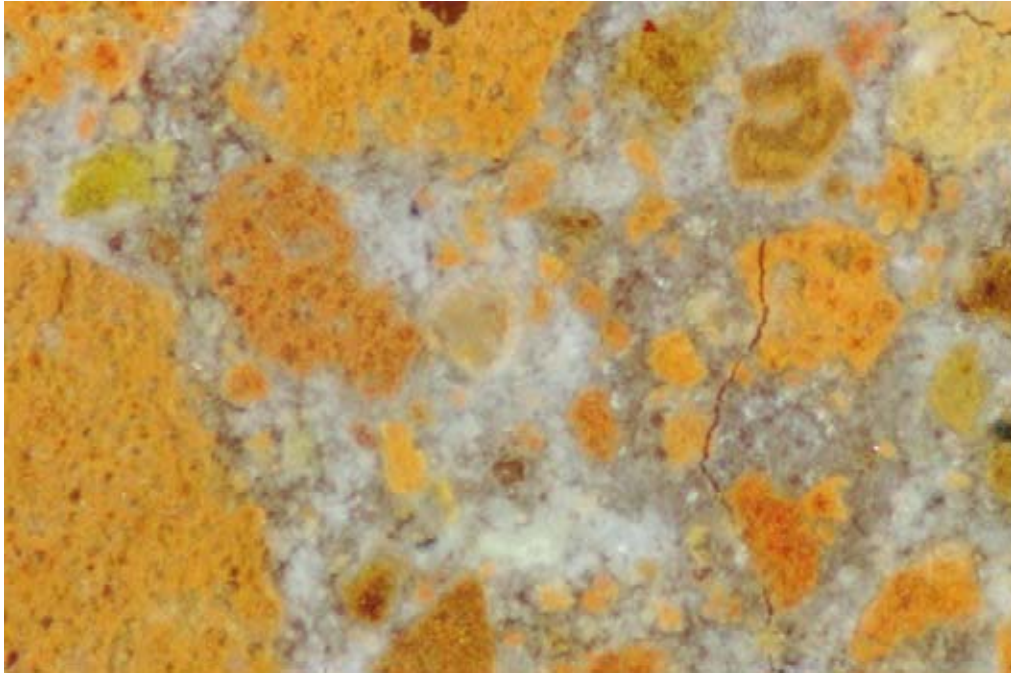

*Figure 6.3: Sample M-006 (25x magnification)*

Sample M-006 (*Figure 6.3*)

This mortar sample was collected from between stones in the south old wall, 1.64m south of the Fuga structure. This sample was chosen for further examination as an example of a possible section of an older pre-existing wall. The matrix is dark cream in color and stains positive for lime. The aggregate contains fine and coarse pozzolana.

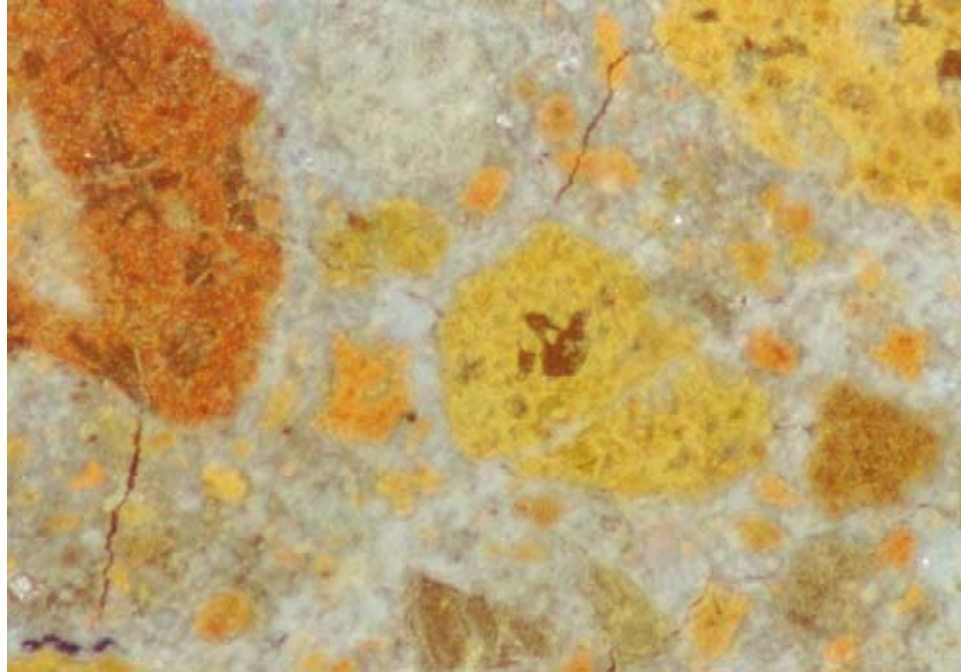

*Figure 6.4: Sample M-007 (25x magnification)*

Sample M-007 (*Figure 6.4*)

This mortar sample was collected from beside an O shaped stone which appears to be very old in the south old wall, south of the *spugne* outcropping. This section is another possible area of older wall which might be contemporaneous with the *prospettiva*. The matrix is also dark cream colored and stains positive for lime. The aggregate contains fine and coarse pozzolana, and fine translucent white sand particles.

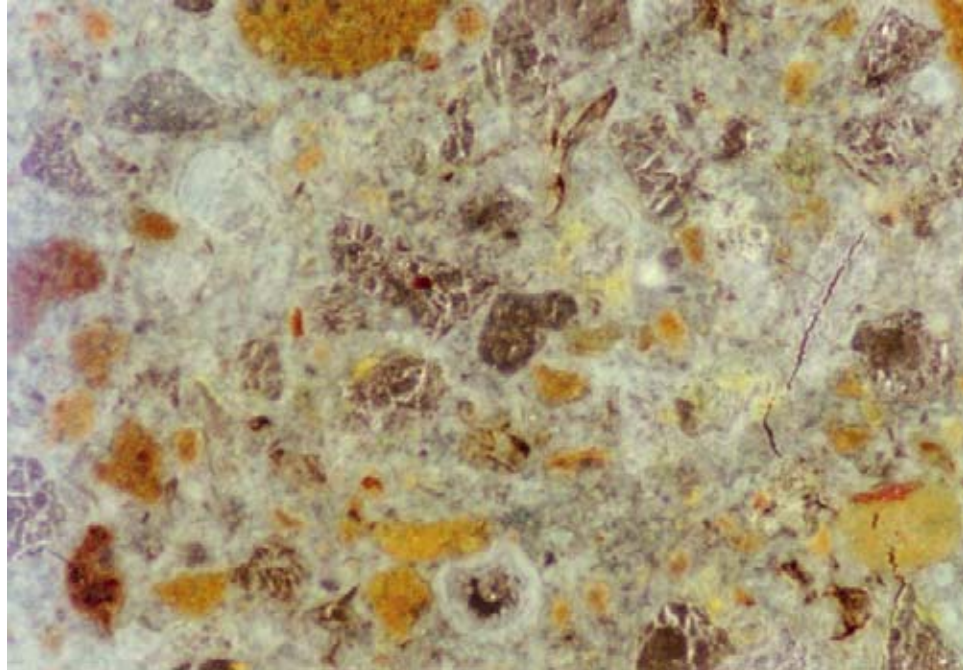

*Figure 6.5: Sample M-008 (25x magnification)*

Sample M-008 (*Figure 6.5*)

This mortar sample was collected from between stones in the north old wall in an area of unusual reddish tuff stones. This area appeared not to be an original part of the older wall, but instead a more recent addition or repair. The lime paste is similar to the typical dark cream colored paste, but the aggregate is markedly different. There is very little pozzolana. The primary component of the aggregate is very fine pale sand.



*Figure 6.6: Sample M-009 (25x magnification)*

Sample M-009 (*Figure 6.6*)

This mortar sample was collected from between bricks on the south corner of the facade of the *prospettiva*. This sample was collected for comparison to those samples taken from the *scalinata*. The lime paste is a dark cream color, and the aggregate is composed of pozzolana ranging in size from very fine to coarse.

Conclusions

While mortars cannot establish dates of construction, they can give supporting evidence for building campaigns based on the similarity of formulations and components. The mor-







tar (M-008) found in the section of red stones in the north wall is atypical in its lack of pozzolana, and seems not to be from the same building traditions of any of the other samples. The preponderance of translucent, quartz sand is reminiscent of the composition of the plaster substrate in sample SC-015 (*Figure 5.4*). The atypical nature of these samples, and the refined appearance of the limewash layer on sample SC-015, suggests that they are more modern repairs or additions.

The mortars from the two south wall locations (M-006, M-007) and the *prospettiva* (M-009) have a similar appearance. Their aggregates are primarily yellow and orange terra cotta colored pozzolana. The *prospettiva* mortar (M-009) and the mortar from the old south wall near the *scalinata* (M-007) could be contemporaneous. The scant amount of fine translucent sand aggregate present in the other old south wall sample (M-006) suggests that this sample may be from a different period, perhaps during a restoration of the wall during the construction of the *scalinata*. All three samples exhibit a dark cream matrix different from the lighter matrix in M-001.

The mortar from the north wall of the *scalinata* (M-001) contains both pozzolana and sand in a light cream colored matrix. This is typical of mortars sampled from the *scalinata* and appears to be representative of the eighteenth century construction.

These findings support the construction sequence suggested by the documentary sources. The older lateral walls and a *prospettiva* structure appear on the site by the late seven-

teenth century (*Figures 3.3 and 3.4*). These masonry features display similar mortars that differ from the mortars of other elements in the group. Fuga's *scalinata* (*Figure 3.5*), and a reconstructed *prospettiva* are constructed in the mid-eighteenth century using slightly different formulations, especially in the choice of aggregates.

Sample	Location	Date	Matrix	Aggregate	Photo (reflected light, 25x mag.)
M-001	<i>scalinata</i> : north wall	ca. 1741	light cream	fine pozzolana; fine & coarse sand	
M-006	<i>scalinata</i> : south wall remnant	17th century	dark cream	fine & coarse pozzolana; no sand	
M-007	<i>scalinata</i> : south wall remnant	17th century	dark cream	fine & coarse pozzolana; fine sand	
M-008	<i>scalinata</i> : north wall remnant	17th century repair	dark cream	no pozzolana; fine sand	
M-009	<i>prospettiva</i> : brick bedding mortar	17th century	dark cream	fine & coarse pozzolana; no sand	

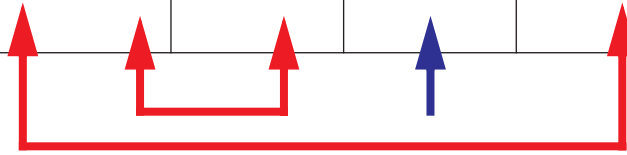

unique mortar



similar mortar pairs

Table 6.1: Comparison of the analyzed mortars

## 7. EXISTING CONDITIONS

Despite its age and years of deferred maintenance, the *scalinata* and *prospettiva* remain in remarkable condition, especially free from later alterations and repairs. Nevertheless both need immediate stabilization and conservation of the surface finishes as part of an overall restoration program for this important feature of the Orto Botanico.

### 7.1 Scalinata

#### Surface Finishes

The surface finishes on the *scalinata* are damaged in many places. There is delamination of the finish plaster in general, and in some places it is missing altogether. This type of damage is most pronounced in the areas where water is not properly draining. This appears to be an ongoing decay process. There are visible repairs throughout the structure. Mortar repairs have been made to the finish plaster using materials that are either dissimilar in composition or color.

There are numerous repair campaigns evident on the north retaining wall. These use different types of stones to replace the missing *spugne* which textured the wall. There are four distinct conditions: original *spugne* stone; composite stone composed of large pebbles and mortar; tufa like stone; and regions of loss (*Figure 7.1*). Smaller repairs of one or two stones using similar materials may be found throughout the textured surfaces.

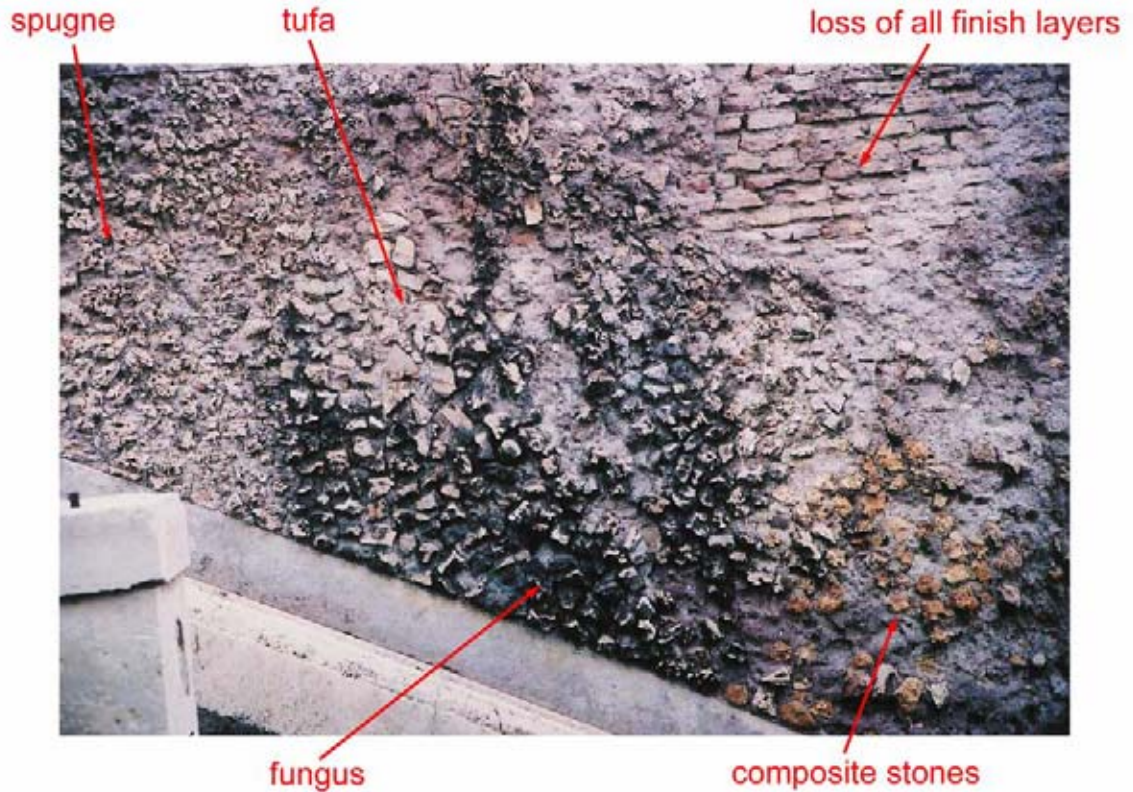

Figure 7.1: Examples of finish materials and conditions found on the north rusticated wall of the *scalinata*. (Sardegna, 2002)

The travertine balustrade at the top of the *scalinata* is eroded extensively, a result of many years of water spray. Many of the balusters have been replaced after sustaining damage presumably by the same means.

### Structure

Many elements of the *scalinata* are either missing or displaced. Several types of terra cotta urns and marble busts originally adorned the walls of the *scalinata*, the large retaining walls, and the walls of the lower stair. Many of the urns that remain are damaged. Others



*Figure 7.2: Pitted travertine surface on the scalinata baluster. (Sardegna, 2002)*



*Figure 7.3: Displaced masonry on the scalinata near the plane trees. (Sardegna, 2002)*

have toppled and now lay on the ground beside the structure. Several of the urns and all of the busts are missing altogether.

### Biogrowth

One of the most serious threats to the structural integrity of the water stair is the presence of vegetation in close proximity. The greatest threat is the plane trees that predate the construction and are now more than 300 years old. The plane trees have extensive root systems extending underneath the lower stairs. The steps have been displaced by the roots allowing water to penetrate and the underlying support to subside. A section of the south wall of the lower stair has been removed due to severe displacement by the tree roots. The plane trees are valuable specimens in the Orto Botanico, and cannot be removed. At the time of the research for this document, work had begun to both correct the displacement of the stones as well as lessen the threat of future damage by the largest roots.

Many other trees surround the water stair, and while they do not pose as great a threat to the stair as the plane trees, they do nonetheless pose a risk if proper maintenance is not regularly performed. Their roots are causing displacement, leaf debris causes acidic soil-ing and moisture retention, and shadowing supports damp conditions suitable for persistent microflora growth.

In addition to the vegetation around the *scalinata*, there are many vines, grasses, and smaller plants causing damage to the finishes of the water stair.

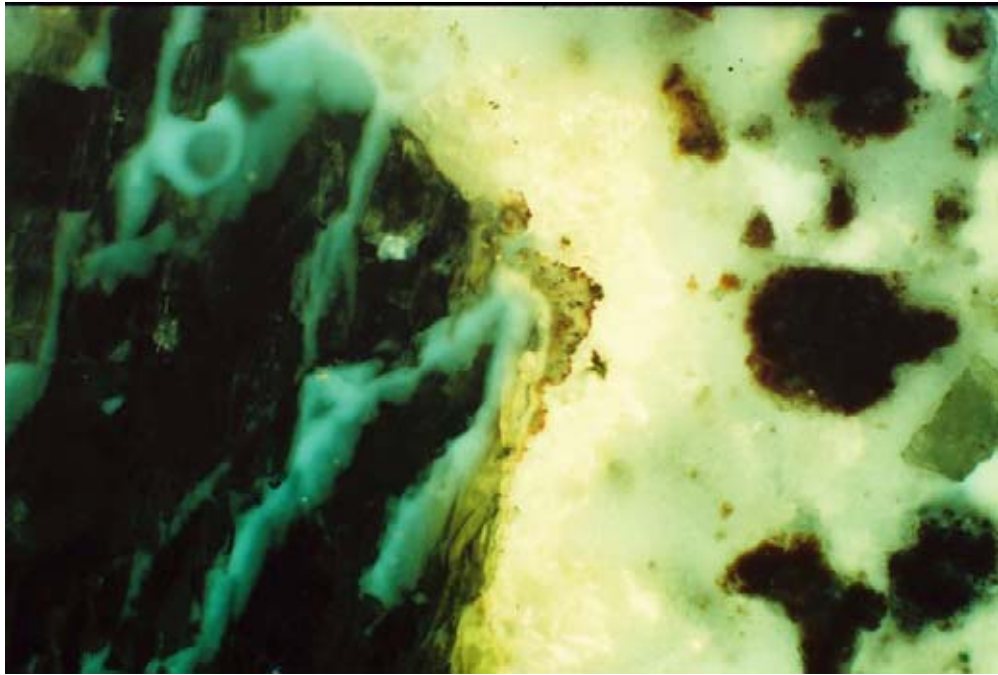

*Figure 7.4:* Crystallized salt within plaster shown in UV photomicrograph (Sample SC-008 at 25x magnification)

Dark colored micro flora (fungus) is growing on the areas where water is leaking through the walls, resulting in considerable staining of older finishes (*Figure 7.1*).

### Salts

There is evidence of efflorescence on areas of the large retaining walls which show other types of decay related to water. While the surface efflorescences are easily removed with water, salts within the masonry (subfluorescence) may be a source of past and future decay. Areas of *spugne* loss and the many repairs on the north retaining wall may be the result of the damage from salts entering the wall through water percolation from above.



## 7.2 Prospettiva

### Surface Finishes

Since the *prospettiva* is situated outside of the Orto Botanico's fence, it does not receive the same maintenance program. From the dates found in graffiti, it appears that the finishes have not been cleaned or repaired since the late nineteenth century. The surface finishes are damaged and heavily soiled. Little limewash remains on the *prospettiva*'s plaster. The finishes within the large niche have been damaged by fire, and are coated with soot.

The *spugne* is missing in many areas. Much of this loss appears to be the result of roots growing through the plaster in which the *spugne* was embedded (*Figure 7.5*). Unlike the walls of the *scalinata*, there is no evidence that the *spugne* finish has been repaired in the past.

### Structural

Many structural elements in the *prospettiva* are damaged. Decorative elements of the broken pediment are missing, leaving much of the top of the structure unprotected. Similarly, the plaster finish is missing in some areas, and the underlying bricks are exposed. Much of the mortar between the exposed bricks has eroded. The missing protection of the plaster elements combined with the action of vegetation and biogrowth described below creates a situation in which the *prospettiva* will quickly degrade further if not remedied quickly.



*Figure 7.5: Example of damage to spugne textured surface caused by roots; also visible on right is missing plaster and exposed brick. (Sardegna, 2002)*

### Biogrowth

The *prospettiva* is currently engulfed by vegetation (*Figure 7.6*). The vines which caused the failure of the plaster surface behind the *spugne* have died in many places although their roots remain. Many saplings and other plants are still growing on the top of the *prospettiva*.



*Figure 7.6: Biogrowth on prospettiva. (Sardegna, 2002)*

A detailed condition report was written in 2002, and may be found in the course report for the University of Pennsylvania's European Studies Course.<sup>1</sup>

---

1. The Graduate Program in Historic Preservation, University of Pennsylvania, "The Orto Botanico and the Scala d'Acqua of Rome", available at: <http://www.design.upenn.edu/hspv/rome/>.

## 8. CONCLUSIONS

The site of Fuga's *Scalinata delle Undici Fontane* and *Prospettiva* has been a series of gardens for millennia, each paying homage to water in its own way. The pre-Renaissance orto composed of groups of grape vines, fruit trees, and medicinal herbs gave way to formal gardens of purely ornamental plants organized by color and texture in the area near the Riario family's new home after the construction of the villa in 1510. The garden gained more architectural structure with the construction of a simple stair and fountain, and a large nymphaeum inspired by classical sources by the early eighteenth century. The architectural structures, the plants, and the palazzo were connected spatially through a central axis that rose up the slope to a *prospettiva*.

Corsini's renovation of the villa starting in 1736 resulted in changes to the formal garden, alterations to the *prospettiva*, and a greater emphasis on water with the addition of the *Fontana dei Tritoni* and the *Scalinata delle Undici Fontane*. Although Fuga made significant changes to the villa, he kept the ties to its past by preserving the axis, now off center with the palazzo, by utilizing portions of the existing stair in the construction of the *scalinata*, and keeping much of the *prospettiva*.

The site's present state combines elements from all its past lives. The plan of the once formal garden is now similar to that of the pre-Renaissance vineyards and fruit orchards. The

Orto Botanico houses an extensive collection of plants, but they are ordered primarily by their functional and scientific values rather than by their aesthetic values.

The design of the *prospettiva* remains unaltered but somewhat neglected. The finishes on the extant portion have not changed greatly for hundreds of years. It survives as a ruin.

The *scalinata*'s appearance has changed little since its construction. The form and those finishes that are extant have remained true to Fuga's intent through more than 250 years. There is evidence of several different repairs of the finishes using limewashes similar to the travertine and cortina colors specified by Fuga in 1741. The *scalinata*, including portions of the older walls, was stabilized structurally and thoroughly cleaned during the summer of 2003 by the Istituto Centrale di Restauro to preserve its form for future generations.

## 9. BIBLIOGRAPHY

*Ferdinando Fuga and the Baroque Era:*

Blunt, Anthony. *Guide to Baroque Rome*. New York: Harper & Row Publishers, 1982.

Borsellino, Enzo. *Palazzo Corsini alla Lungara*. Rome: Schena Editore, 1988.

Gambardella, Alfonso, ed. . *Ferdinando Fuga: 1699-1999: Roma, Napoli, Palermo*.  
Napoli: Edizioni Scientifiche Italiane, 2001.

Frutaz, Amato Pietro, ed. *Le Pianta di Roma*, vol II. Rome: Istituto di Studi Romani,  
1962.

Kievan, Elisabeth. *Architettura del Settecento a Roma: nei Disegni della Raccolta Grafica  
Comunale*. Roma: Carte Segrete, 1991.

Kievan, Elisabeth. *Ferdinando Fuga e l'architettura romana del Settecento: I disegni di  
architettura dalle collezioni del Gabinetto Nazionale delle Stampe*. Roma: Multi-  
grafica Editrice, 1988

Matthiae, Guglielmo. *Ferdinando Fuga e la Sua Opera Romana*. Roma: Fratelli Palombi,  
1952.

Portughesi, Paolo. *Roma Barocca*. Bari: Editori Laterza, 1988.

*Mortar and Plaster Analysis:*

Berlucci, N. and R. Ginanni Corradini. "Diagnostic Surveys of the Facades of the Capito-  
line Palaces in Rome: A Contribution to Knowledge and to Methods of Restoration."  
Available at: <http://www.unesco.org/archi2000/pdf/berlucci.pdf>

Ferroni, Enzo. "Chimica fisica degli intonaci affrescati." *Problemi di Conservazione*,  
(1973), pp. 269-281.

Fratini, Fabio; Manganelli, Carlo; Matteini, Mauro; Moles, Arcangelo; Pecchioni, Elena;  
and Rizzi, Maria. "Il "Colosso dell' Appennino" del Giambologna: studio delle malte e  
dei laterizi pertinenti della struttura e del rivestimento." *Le pitture murali: tecniche,  
problemi, conservazione*. Centro Di della Edifimi s.r.l., Danti, Cristina, Matteini,  
Mauro, and Moles, Arcangelo, Editors(1990), pp. 59-72.

- Goins, Elizabeth. "A standard method for the analysis of historic cementitious materials." *NCPTT notes*, no. 36 (2000 Jul).
- Gulec, Ahmet and Ersen, Ahmet. "Characterization of ancient mortars: evaluation of simple and sophisticated methods." *Journal of Architectural Conservation*, vol. 4, no. 1 (1998), pp. 56-67.
- Rava, Antonia. "Restauro e Colorature di Edifici Storici a Roma." *Coloriture e Trattamenti degli Edifici Storici a Roma*, Luisa Cardilli, ed. Rome: Assessorato alla Cultura, Soprintendenza Comunale, 1990, pp. 42-51.
- Stewart, John and Moore, James. "Chemical techniques of historic mortar analysis." *Mortars, cements and grouts used in the conservation of historic buildings. Symposium, Rome, 3-6 Nov. 1981*. International Centre for the Study of the Preservation and the Restoration of Cultural Property, (1982), pp. 297-310.
- Stewart, John and Moore, James. "Chemical techniques of historic mortar analysis." *APT bulletin*, 14, no. 1 (1982), pp. 11-16
- Wetter, Karin. "The possibility of dating Roman monuments built of Opus caementicium by analysing the mortar." *Opuscula Romana*, 12, no. 4 (1979), pp. 45-46.
- Nymphae and Grotto Structures, and Historic Gardens:*
- Ballerini, Isabella Lapi and Litta Maria Medri, eds. *Artifici d'Acque e Giardini: La Cultura delle Grotte e dei Ninfei in Italia e in Europa*. Firenze: Centro di, 1999.
- Barisi, Isabella. "Il disegno del giardino e l'architettura vegetale." *Villa D'Este*. (Rome: De Luca Editori D'Arte S.r.l., 2003) pp. 55-81.
- Fagiolo, Marcello. *Roman Gardens*. New York: Monacelli Press, 2001.
- Magnani, Lauro, ed. *Tra Magia, Scienza e "Meraviglia": le Grotte artificiali dei Giardini Genovesi nei secoli XVI e XVII*. Genova: Sagep Editrice, 1984.
- Miller, Naomi. *Heavenly Caves*. New York: George Braziller, Inc., 1982.
- Morel, Philippe. *Les Grottes mani ristes en Italie au XVI<sup>e</sup> si cle: Th tre et alchimie de la nature*. Paris: ditions Macula, 1998.
- University of Pennsylvania. *The Orto Botanico and the Scala d'Acqua of Rome*, 2002, available at: <http://www.design.upenn.edu/hspv/rome/>

## APPENDIX A: SAMPLE LOCATIONS

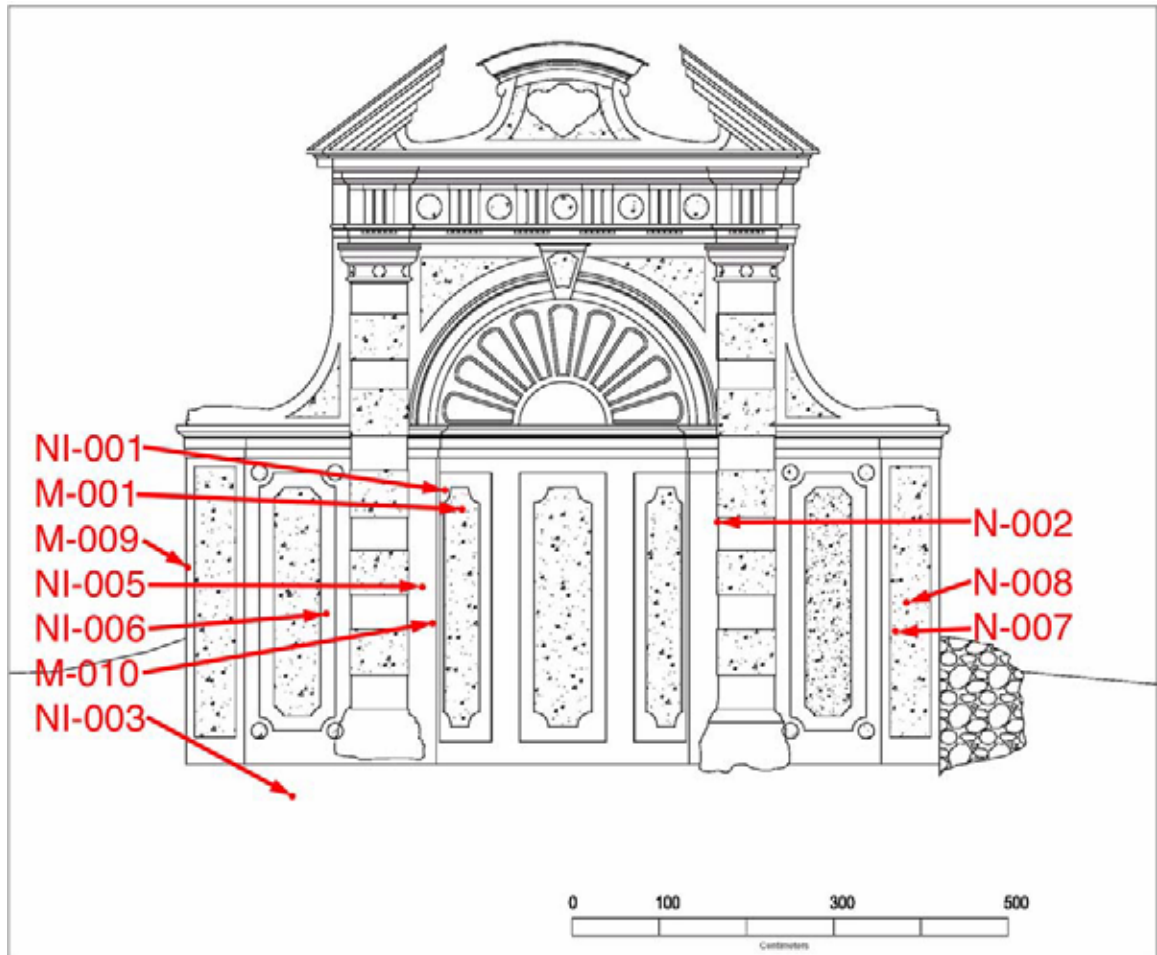

Figure A.1: Locations of the samples collected from the *prospettiva* (CAD drawing: University of Pennsylvania, *The Orto Botanico and the Scala d'Acqua of Rome*, 2002)



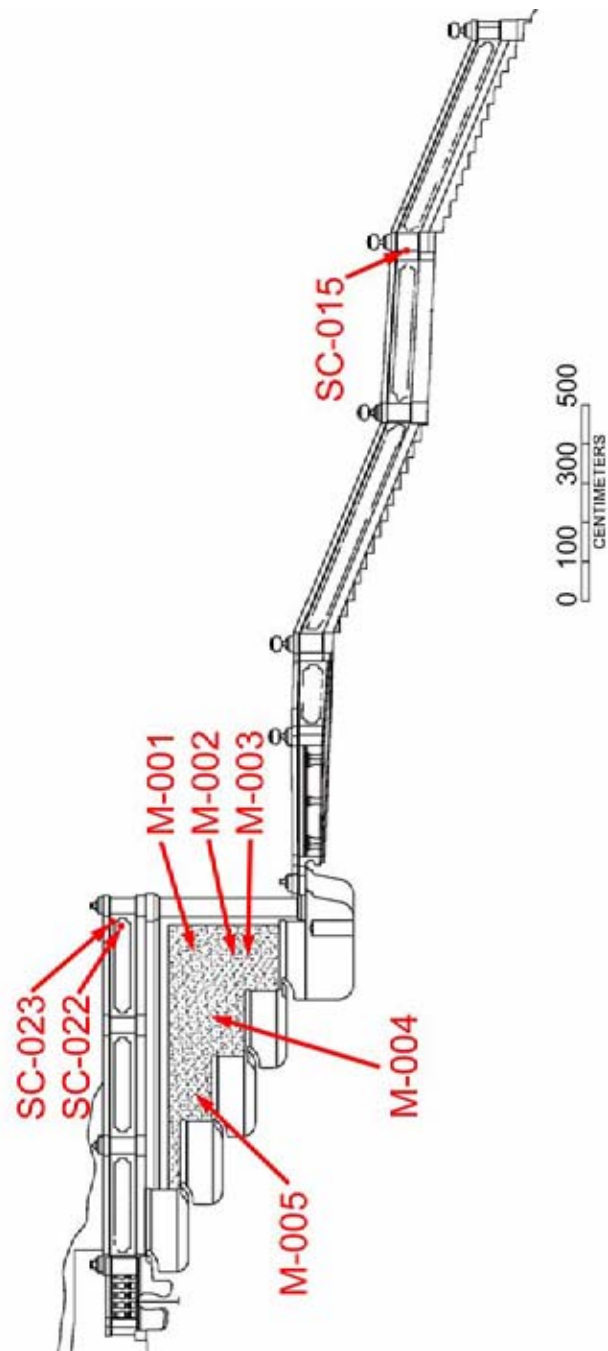

Figure A.2: Locations of the samples collected from the north wall of the *scalinata* (CAD drawing: University of Pennsylvania, *The Orto Botanico and the Scala d'Acqua of Rome*, 2002)

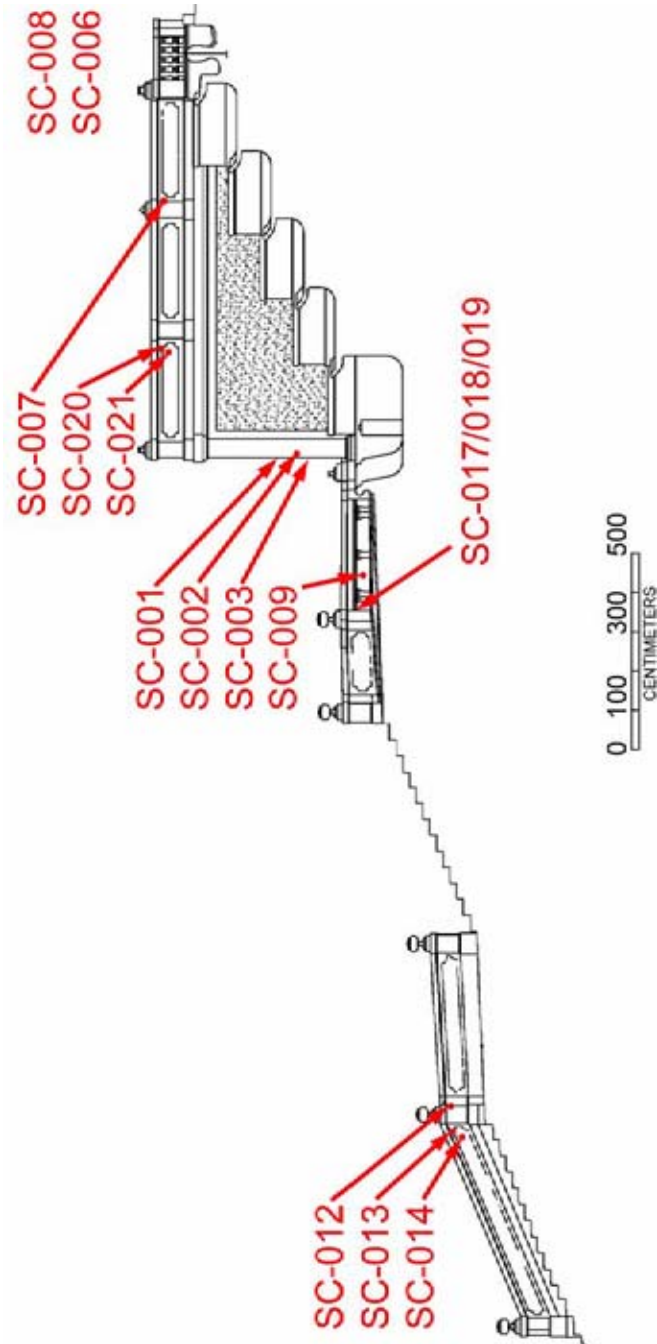

Figure A.3: Locations of the samples collected from the south wall of the *scalinata* (CAD drawing: University of Pennsylvania, *The Orto Botanico and the Scala d'Acqua of Rome*, 2002)

## APPENDIX B: TABLES OF SAMPLES

### Scalinata Samples

NUMBER	SAMPLE	LOCATION	CHARACTERISTICS (at 7.1x mag)	LAYERS (from topmost to substrate)
SC-003	finish coat, decorative	rondel	yellow limewash layer: 10YR 7/4 with fine layer of fine red pozzolana underneath mortar: 10YR 9/1 with very little agg	1. cream substrate
SC-005	finish coat, decorative	ballustrade curve of end bracket	no paint layer mortar: 5YR 9/1	
SC-009	finish coat, decorative	under south bench		3. cream 2. yellow 1. deep yellow substrate
SC-017	finish coat, decorative	SE wall beside south bench	yellow limewash layer: 10YR 8/6 mortar: 10P 9/1 with red pozzolana inclusions (fine to ~ 3mm)	1. yellow substrate
SC-013	finish coat, frame	south wall lower stair frame of panel	cream limewash: 10YR 9/ 2 and 10YR 6/4, fine layer of red pozzolana under mortar: 10P 9/1	1. white substrate
SC-020	finish coat, frame rail	frame of panel: south scala wall frontmost panel	no paint layer mortar: 10P 9/1 with layer of fine red pozzolana as surface decoration (5R 4/ 2); 1-2mm pozzolana inclusions + other pale agg of similar size	NA

NUMBER	SAMPLE	LOCATION	CHARACTERISTICS (at 7.1x mag)	LAYERS (from topmost to substrate)
SC-023	finish coat, frame rail	frame of panel: north scala wall frontmost panel, taken near SC-022	no paint layer mortar: 10P 9/1 with layer of fine red pozzolana as surface decoration (5R 4/ 2); 1-2mm brick inclusions + other pale agg of similar size	red pozzolana
SC-006	finish coat, interior field	middle of southwest most upper panel on scala	no paint layer mortar: 10R 9/1 some red pozzolana near surface	
SC-008	finish coat, interior field	middle of southwest most upper panel on scala; shows remains of paint layer	pink limewash layer: 5R 8/4 with layer of red pozzolana underneath, and layer of grey mortar above 10R 8/1 mortar: 10R 9/1 with very little agg or pozzolana	1. pink substrate
SC-014	finish coat, interior field	south wall lower stair middle textured field of panel	pink limewash layer: 2.5R 8/4 with inclusions of red pozzolana in finish (possible that this is abrasion, but may be intentional) mortar: 5YR 9/1 with very little agg or pozzolana	1. pink substrate
SC-016	finish coat, interior field	south wall lower stair middle non- textured field of panel	creamy yellow limewash layer: 10YR 9/2 very thin, worn mortar: 5YR 8/1 some aggregate, pozzolana; more intense layer of pozzolana near finish	1. cream substrate

NUMBER	SAMPLE	LOCATION	CHARACTERISTICS (at 7.1x mag)	LAYERS (from topmost to substrate)
SC-021	finish coat, interior field	interior textured field: taken near SC-020	no paint layer mortar: 10P 9/1 red pozzolana near surface (10R 4/4)	
SC-022	finish coat, interior field	interior textured field: taken near SC-023	no paint layer mortar: 10R 9/1 red pozzolana near surface (5R 4/2)	red pozzolana
SC-001	finish coat, pilaster	return of S pilaster	yellow limewash layer: 10YR 7/4 with fine layer of fine red pozzolana underneath mortar: 10YR 9/1 with very little agg	
SC-002	finish coat, pilaster	flat of S pilaster	yellow limewash layer: 10YR 7/4 with fine layer of fine red pozzolana underneath mortar: 10YR 9/1 with very little agg	2. cream 1. cream substrate
SC-007	finish coat, pilaster	return of SW most pilaster upper scala	brown yellow limewash layer: 10YR 5/2 with fine layer of red pozzolana underneath mortar: 10YR 9/1 with very little agg.	1. creamy white substrate

NUMBER	SAMPLE	LOCATION	CHARACTERISTICS (at 7.1x mag)	LAYERS (from topmost to substrate)
SC-012	finish coat, pilaster	return of pilaster, south wall, first landing, E pilaster	limewash: yellow 10YR 8/ 4 with darker spots; reddish 10R 7/6 and 10R 5/8 mortar: repair 10R 7/1 with 3-4mm red brick inclusions; older 10PB 9/ 1	3. cream 2. orangish white 1. orange substrate
SC-015	finish coat, pilaster	north wall lower stair W return of pilaster	white limewash layer: 10YR 9/1 (a bit paler) mortar: 5RP 8/1	1. white substrate
SC-019	finish coat, pilaster	SE wall beside south bench	cream limewash layer: 10YR 9/1 (darker parts 10YR 8/2) mortar: 5RP 7/1	1. white substrate
SC-004	mortar	back of S bench		
SC-010	piece of coral rock	north wall of scala, rock type section D		

## Prospettiva Samples

NUMBER	SUBJECT	LOCATION	CHARACTERISTICS (at 7.1x mag)	LAYERS (from topmost to substrate)
NI-001	finish plaster, frame	inside niche, south panel, upper framing field	appears to have cream limewash under soot/soiling mortar: 10YR 9/1 with fine pozzolana + fine agg (yellow pozzolana or tufa?)	1. cream substrate
NI-002	finish plaster, pilaster	return of N pilaster	buff limewash finish: 5YR 8/2 with darker spots (soiling?) mortar: 5YR 9/1 with little incl except near finish (scattered fine red pozzolana)	1. cream substrate
NI-003	plaster	16cm below grade under large S panel	mortar: 10YR 9/1 with coarse agg, some medium red pozzolana	
NI-004	plaster	found in excavation; has colored coat	appears to be similar to NI-015 or 016	2. cream 1. cream fine layer coarse layer
NI-005	finish plaster, frame	outside of niche on S wall before pilaster	yellow limewash finish: 2.5Y 8/ 4 with soiling mortar: 5R 8/1 with some medium to coarse red pozzolana, a few very large particles 5-8mm	1. cream substrate
NI-006	finish plaster, frame	inside frame of large S panel	yellow limewash finish: 10YR 8/6 mortar: 10RP 9/1 with 3-4mm red pozzolana inclusions +fine agg	2. cream 1. cream substrate

NUMBER	SUBJECT	LOCATION	CHARACTERISTICS (at 7.1x mag)	LAYERS (from topmost to substrate)
NI-007	finish plaster, frame	N most panel	appears to have pale limewash under black soot layer mortar: 5YR 8/1 with fine red pozzolana, fine agg (maybe yellow brick/tufa?)	1. cream substrate
NI-008	finish plaster, frame	N most panel	white limewash (?) finish: 10YR 9/2 mortar: 5YR 9/1 with fine agg; layer of 3-4mm red and orange pozzolana	2. cream 1. cream substrate
NI-015	finish plaster, frame	outside frame of large south panel	yellow limewash finish: 10YR 8/4 mortar: 10YR 9/1 with fine red pozzolana	2. cream? 1. cream substrate
NI-016	finish plaster, pilaster	return of S pilaster	yellow limewash finish: 10YR 9/2 > 10YR 8/2 > 10YR 7/4 mortar: 10YR 9/1 with some fine to medium red pozzolana	2. cream? 1. cream substrate
NI-017	finish plaster, frame	frame of N most panel	white limewash finish: 10YR 8/ 1 mortar: 10YR 9/1 with fine red pozzolana near finish surface	1. cream substrate
NI-018	finish plaster, frame	rear wall of niche btn mid and S panels	appears to have pale limewash under black soot layer mortar: 5YR 9/1 with some fine red pozzolana, fine agg (maybe yellow brick/tufa?)	2. brown (fire damage?) 1. cream substrate
NI-019	finish plaster, frame	outside frame of N most panel inside niche	buff limewash finish: 7.5YR 8/2 with darker pattern (soiling?) mortar: 7.5YR 9/2 with fine agg, some fine red pozzolana	1. cream substrate



## Mortar Samples

NUMBER	SUBJECT	LOCATION	THIN SECTION OBSERVATION
M-001	mortar from between bricks where plaster/rock finish is missing	north scala wall; rock type section A	some fine pozzolana; very fine white translucent particles; fine white translucent particles w/lattice structure; light cream lime paste
M-002	mortar around composite stones	north scala wall; rock type section B	
M-003	mortar around composite stones	north scala wall; rock type section B	
M-004	mortar around composite stones	north scala wall; rock type section C	
M-005	mortar around composite stones	north scala wall; rock type section D	
M-006	mortar from between stones	south old wall, 164 cm from Fuga wall	coarse pozzolana; very fine pozzolana; dark cream lime paste
M-007	mortar from beside O shaped stone	south old wall, south of grotto formation	coarse pozzolana; some fine pozzolana; some fine translucent white particles; very fine pozzolana throughout; dark cream lime paste

NUMBER	SUBJECT	LOCATION	THIN SECTION OBSERVATION
M-008	mortar from between stones	north old wall: area of reddish stones	very fine pale translucent particles throughout; some fine pozzolana; dark cream lime mortar
M-009	mortar from between bricks	south corner of nicchione	coarse to very fine pozzolana; dark cream lime paste
M-010	mortar from between bricks	south corner of niche, middle of column	
M-011	decorative mortar around stones	inside niche, south panel, upper interior field	
M-020	mortar from between stones	yellow stone portion of north old wall (northmost section of old wall)	

## Munsell Color Reference<sup>1</sup>

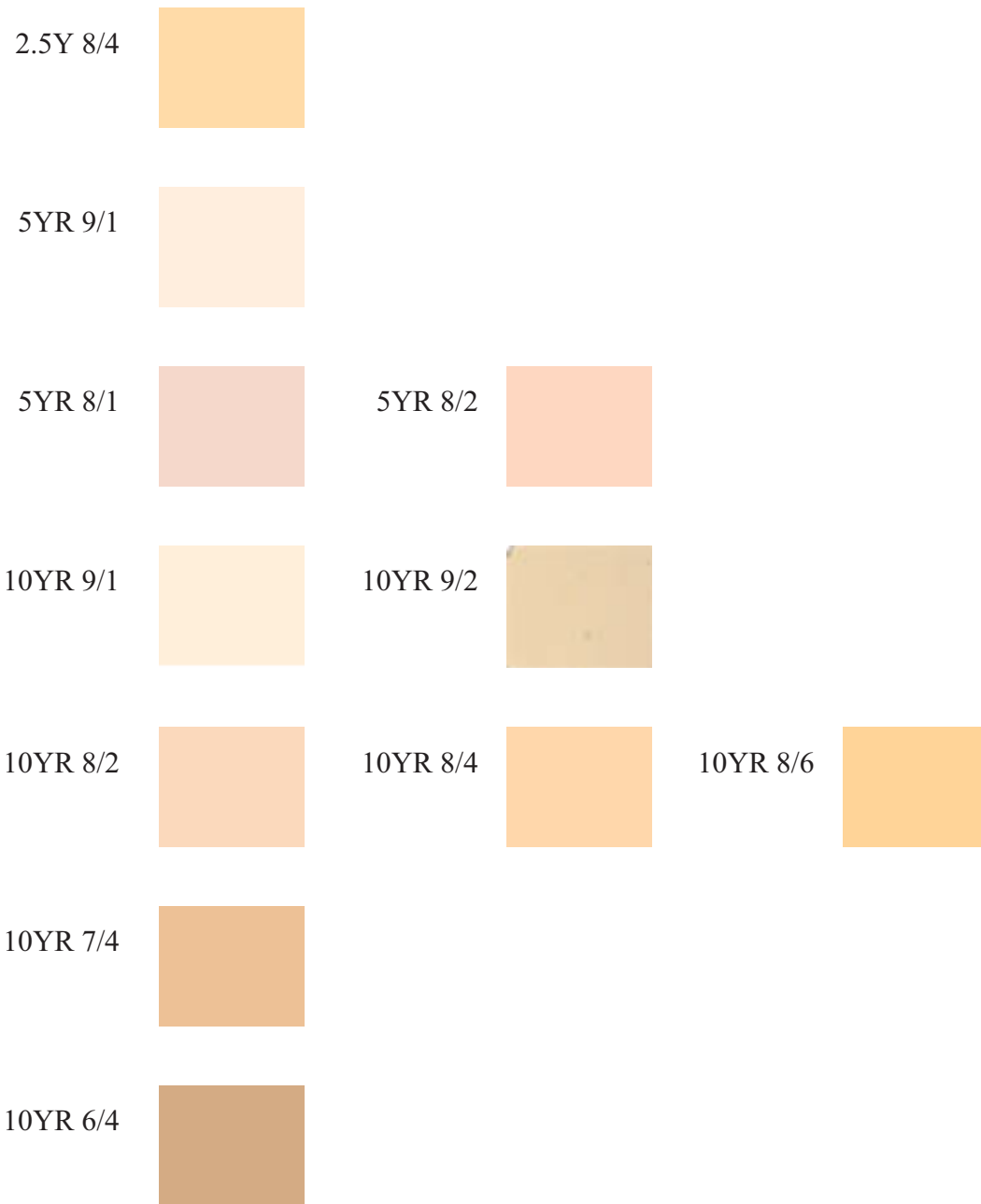

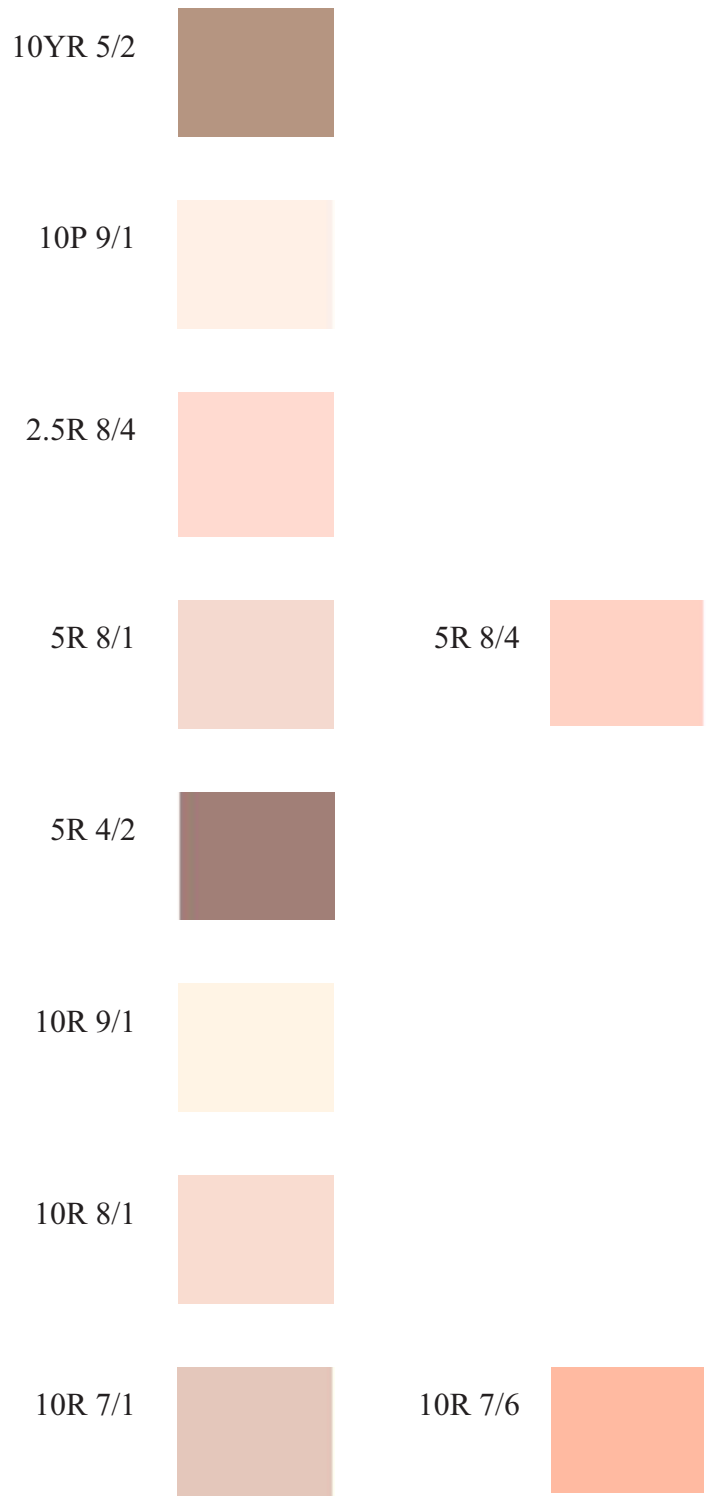

---

1. These colors are given for reference and comparison only. A Munsell color reference book should be consulted for more accurate representations of the colors noted.

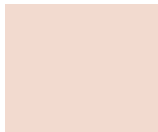

10R 5/8 

5RP 8/1 

5RP 7/1 

## INDEX

### B

Biogrowth, *prospettiva* 68

Biogrowth, *scalinata* 65

### C

Capitoline Palaces 32, 33

Christina of Sweden 17

Clemente XII 27

composite stone 62

Corsini 20

Cortina 43

cortina color finish 43, 48

### D

DuPerac 13

### E

efflorescence 66

### F

*Fontana dei Draghi* 26

fungus 66

### G

G.B. Foggini 27

green theater 30, 33

grotto 23

### H

Horti Getae 12

### M

map of 1577 Rome 13

map of 1748 Rome 17

map of eighteenth century *scalinata* site 15

micro flora 66

### N

Nolli 17

nymphae 23

nymphaeum 24

## P

Paoli 13  
plane trees 65

## R

Riario 12

## S

Salts 66  
Santa Maria Maggior 29  
*Scala dei Bollori* 26, 33  
springs 29  
*spugne* 23, 24, 31, 62  
Structural condition, *prospettiva* 67  
Structure conditions, *scalinata* 63  
Surface Finish conditions, *prospettiva* 67  
Surface Finish conditions, *scalinata* 62

## T

Teatro della Verdura 33  
Travertine 37  
travertine color finish 37

## V

Villa Aldobrandini del Belvedere 33  
Villa d'Este 25,33  
Villa Farnese 26