



3-2013

Event-based Green Scheduling of Radiant Systems in Buildings

Truong X. Nghiem

University of Pennsylvania, nghiem@seas.upenn.edu

George Pappas

University of Pennsylvania, pappasg@seas.upenn.edu

Rahul Mangharam

University of Pennsylvania, rahulm@seas.upenn.edu

Follow this and additional works at: https://repository.upenn.edu/mlab_papers



Part of the [Controls and Control Theory Commons](#), and the [Power and Energy Commons](#)

Recommended Citation

Truong X. Nghiem, George Pappas, and Rahul Mangharam, "Event-based Green Scheduling of Radiant Systems in Buildings", . March 2013.

BibTeX:

```
@INPROCEEDINGS{NghiemEtAl13acc, author = {Truong X. Nghiem and George J. Pappas and Rahul Mangharam}, title = {Event-based Green Scheduling of Radiant Systems in Buildings}, booktitle = {American Control Conference (ACC)}, year = {2013}, month = {June} }
```

© 2013 IEEE. Personal use of this material is permitted. Permission from IEEE must be obtained for all other uses, in any current or future media, including reprinting/republishing this material for advertising or promotional purposes, creating new collective works, for resale or redistribution to servers or lists, or reuse of any copyrighted component of this work in other works.

This paper is posted at ScholarlyCommons. https://repository.upenn.edu/mlab_papers/57
For more information, please contact repository@pobox.upenn.edu.

Event-based Green Scheduling of Radiant Systems in Buildings

Abstract

This paper looks at the problem of peak power demand reduction for intermittent operation of radiant systems in buildings. Uncoordinated operation of the circulation pumps of a multi-zone hydronic radiant system can cause temporally correlated electricity demand surges when multiple pumps are activated simultaneously. Under a demand-based electricity pricing policy, this uncoordinated behavior can result in high electricity costs and expensive system operation. We have previously presented Green Scheduling with the periodic scheduling approach for reducing the peak power demand of electric radiant heating systems while maintaining indoor thermal comfort. This paper develops an event-based state feedback scheduling strategy that, unlike periodic scheduling, directly takes into account the disturbances and is thus more suitable for building systems. The effectiveness of the new strategy is demonstrated through simulation in MATLAB.

Keywords

green scheduling, event-triggered, radiant systems, buildings, peak reduction, energy

Disciplines

Controls and Control Theory | Power and Energy

Comments

BibTeX:

```
@INPROCEEDINGS{NghiemEtAl13acc, author = {Truong X. Nghiem and George J. Pappas and Rahul Mangharam}, title = {Event-based Green Scheduling of Radiant Systems in Buildings}, booktitle = {American Control Conference (ACC)}, year = {2013}, month = {June} }
```

© 2013 IEEE. Personal use of this material is permitted. Permission from IEEE must be obtained for all other uses, in any current or future media, including reprinting/republishing this material for advertising or promotional purposes, creating new collective works, for resale or redistribution to servers or lists, or reuse of any copyrighted component of this work in other works.

Event-based Green Scheduling of Radiant Systems in Buildings

Truong X. Nghiem, George J. Pappas and Rahul Mangharam
Department of Electrical and Systems Engineering
University of Pennsylvania
{nghiem, pappasg, rahulm}@seas.upenn.edu

Abstract—This paper looks at the problem of peak power demand reduction for intermittent operation of radiant systems in buildings. Uncoordinated operation of the circulation pumps of a multi-zone hydronic radiant system can cause temporally correlated electricity demand surges when multiple pumps are activated simultaneously. Under a demand-based electricity pricing policy, this uncoordinated behavior can result in high electricity costs and expensive system operation. We have previously presented Green Scheduling with the periodic scheduling approach for reducing the peak power demand of electric radiant heating systems while maintaining indoor thermal comfort. This paper develops an event-based state feedback scheduling strategy that, unlike periodic scheduling, directly takes into account the disturbances and is thus more suitable for building systems. The effectiveness of the new strategy is demonstrated through simulation in MATLAB.

I. INTRODUCTION

Radiant heating and cooling systems, or radiant systems for short, serve as an alternative to the conventional forced-air heating, ventilating and air conditioning (HVAC) systems for buildings. In radiant systems, heat is supplied to or removed from building elements such as floors, ceilings and walls by circulating water, air or electric current through a circuit embedded in or attached to the structure [1]. Radiant systems depend largely on radiant heat transfer between the thermally controlled building elements and the conditioned space. The benefits of radiant systems over forced-air HVAC systems for residential and commercial buildings have been well-studied [2]. Essentially, there are three major benefits: human comfort, reduced heat loss, and peak energy demand reduction. Because the building elements used in radiant systems have high thermal mass, they serve as energy storage whose slow thermal behaviour is exploited to provide cooling or heating. Hence, the building's thermal mass can be utilized to flatten out peaks in energy demand. Nowadays, radiant systems are widely used in buildings in Korea, Germany, Austria, Denmark and some parts of the United States [3].

Two-position control is the simplest control method for radiant systems, where the system is switched on/off when the zone temperature reaches certain thresholds. Outdoor reset control, which sets the supply water temperature according to the ambient air temperature by a predetermined rule, and PID control are also used in practice [1]. More advanced control methods for radiant systems have also been proposed, e.g., model predictive control was shown to improve the comfort and energy consumption of radiant systems in [4].

Recently, intermittent operation of the circulation pumps in hydronic radiant systems was investigated in [5] for reducing the electricity consumption of radiant systems. The focus of [5] was on maintaining the thermal comfort in a single zone. However, intermittent operation can cause highly fluctuating electricity demand of the pumps, which results in high peaks in the electricity demand. Particularly, in a system of multiple zones with multiple pumps, temporally correlated electricity demand spikes can occur when multiple pumps are activated simultaneously. High peaks in electricity demand are costly under a demand-based electricity pricing policy, in which a customer is charged for both its electricity consumption and its peak demand over the billing cycle. The unit price of the peak demand charge is usually very high to discourage the use of electricity under peak load conditions. Many commercial electricity customers are subject to demand-based pricing. Therefore reducing the peak electricity demand of intermittent operation of radiant systems is desirable.

In our recent paper [6], the *Green Scheduling* approach was proposed to schedule the operation of electric radiant systems to reduce the aggregate peak power demand while ensuring that indoor thermal comfort is always maintained. We studied periodic scheduling, which was simple and scalable but did not take into account disturbances (which are often abundant in building systems). *The major contribution of this paper is to develop an event-based state feedback scheduling strategy, which directly handles the disturbances and is therefore more suitable for buildings.* Through simulation in MATLAB of a 10-zone hydronic radiant system, our approach was shown to achieve a 77.8% reduction in peak demand and a 31.2% reduction in total energy consumption, compared to uncoordinated operation of the pumps.

This paper is organized as follows. Section II presents the hydronic radiant system's model and formulates the Green Scheduling problem. We develop the new scheduling algorithm in Sections III and IV and demonstrate it through MATLAB simulations in Section V. We discuss related work in Section VI. Finally, Section VII concludes the paper with a summary and future research directions.

II. SYSTEM'S MODEL AND PROBLEM DEFINITION

In hydronic radiant systems, hot or chilled supply water is pumped through a system of tubes laid in a pattern inside the radiant building elements. Consider two zones equipped with a hydronic radiant system as depicted in Fig. 1. Embedded in a slab under the floor or above the ceiling of each zone is a piping system that carries water from a supply source, e.g., a boiler for heating or a chiller for cooling. The piping systems for the zones are separate from each other. As illustrated in

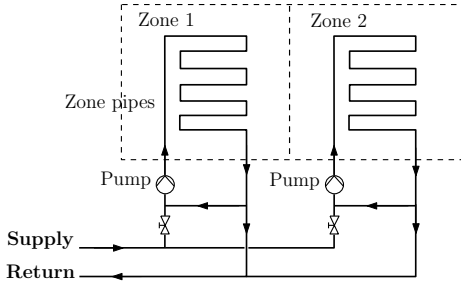

Fig. 1: Diagram of a hydronic radiant system for two zones.

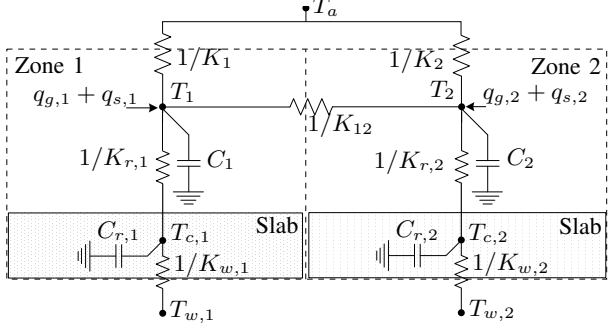

Fig. 2: RC network model of the radiant system in Fig. 1.

Fig. 1, each zone has its own supply and return pipes as well as a circulation pump. This hydronic circuit topology is similar to that used in [5].

A. Intermittent Operation of Radiant Systems

For the hydronic radiant system in Fig. 1, the supply water temperature and the mass flow rate by the pump are the two manipulatable variables for low level control. In practice, typically one of these two controllable variables is fixed or only changed infrequently. That is, either the supply water temperature is fixed and variable speed control is used for the pump, or the pump runs at constant speed and the supply water temperature is varied. However, both options require continuous operation of the circulation pump, which can result in high electricity cost of the radiant system.

Intermittent operation of the circulation pump was studied in [5] for reducing the energy consumption of radiant systems. Essentially, the supply water temperature is fixed and the pump is either switched off or operated at a constant speed. Because of the high thermal inertia of the radiant systems, this simple control method is appropriate for regulating the zone temperature. Furthermore, as the pump no longer runs continuously, the electricity consumption and cost of the system can be reduced. In this paper, we assume this intermittent control method for the circulation pumps.

B. Thermal Model for Radiant Systems

Similar to [7], we assume that the slab is uniformly heated and there is no lateral temperature difference or heat transfer. For each zone, the thermal dynamics from the supply water temperature to the zone temperature is then modeled using a Resistance–Capacitance (RC) network model as shown in Fig. 2. The model for each zone i , $i = 1, 2$, has 4 nodes: T_a is the common ambient air temperature, T_i is the zone temperature, $T_{c,i}$ is the core temperature, and $T_{w,i}$ is the supply water temperature. The parameters and variables of the RC network model are summarized in Table I. We

TABLE I: Parameters of the model in Fig. 2, for $i = 1, 2$.

T_a	ambient air temperature ($^{\circ}\text{C}$)
T_i	air temperature of zone i ($^{\circ}\text{C}$)
$T_{c,i}$	core temperature of the slab of zone i ($^{\circ}\text{C}$)
$T_{w,i}$	supply water temperature for zone i ($^{\circ}\text{C}$)
$q_{g,i}$	internal heat gain of zone i (W/m^2)
$q_{s,i}$	heat gain due to solar radiation of zone i (W/m^2)
K_i	thermal conductance between T_i and T_a ($\text{W}/(\text{K m}^2)$)
$K_{r,i}$	thermal conductance between $T_{c,i}$ and T_i ($\text{W}/(\text{K m}^2)$)
$K_{w,i}$	piping thermal conductance of zone i ($\text{W}/(\text{K m}^2)$)
K_{ij}	thermal conductance between zone i and zone j ($\text{W}/(\text{K m}^2)$)
C_i	thermal capacitance of zone i (J/K)
$C_{r,i}$	thermal capacitance of the slab of zone i (J/K)

can now write the differential equations for the thermal dynamics of the zones and their radiant systems. When the pump of zone i is circulating water in its piping system, the differential equation for the core temperature node $T_{c,i}$ is

$$C_{r,i} \frac{dT_{c,i}}{dt} = K_{r,i}(T_i - T_{c,i}) + K_{w,i}(T_{w,i} - T_{c,i}) \quad (1)$$

When the pump is not running, equivalently the supply water temperature node $T_{w,i}$ is removed, we have

$$C_{r,i} \frac{dT_{c,i}}{dt} = K_{r,i}(T_i - T_{c,i}). \quad (2)$$

The differential equation for the zone temperature T_i is

$$C_i \frac{dT_i}{dt} = K_{r,i}(T_{c,i} - T_i) + K_i(T_a - T_i) + \sum_{j \neq i} K_{ij}(T_j - T_i) + q_{g,i} + q_{s,i}. \quad (3)$$

The model for each zone i has two state variables T_i and $T_{c,i}$. It also has three disturbance variables T_a , $q_{g,i}$ and $q_{s,i}$. The supply water temperature $T_{w,i}$ can be regulated or fixed, depending on the control method for the radiant system.

Let us consider $n > 1$ zones instead of two zones and suppose that $T_{w,i}$ are fixed for all i . Define the state vector $x = [T_1, T_{c,1}, \dots, T_n, T_{c,n}]^T \in \mathcal{X} = \mathbb{R}^{2n}$ and the disturbance vector $d = [q_{g,1}, q_{s,1}, \dots, q_{g,n}, q_{s,n}, T_a]^T \in \mathbb{R}^{2n+1}$. Let binary variable $u_i \in \{0, 1\}$ denote the status of pump i : $u_i = 1$ if the pump is running and $u_i = 0$ otherwise. Define the binary vector $u = [u_1, \dots, u_n] \in \{0, 1\}^n$. Then Eqs. (1) to (3) for all zones can be combined in a state-space model:

$$\begin{aligned} \dot{x}(t) &= (A_0 + \sum_{i=1}^n A_i u_i(t))x(t) + Bu(t) + Wd(t) \\ &= A(u(t))x(t) + Bu(t) + Wd(t) \end{aligned} \quad (4)$$

where $A(u) = A_0 + \sum_{i=1}^n A_i u_i$. We note that:

- The state matrix $A(u)$ depends on u (i.e., switching state matrix) because the differential equation of $T_{c,i}$ changes with respect to u_i (Eqs. (1) and (2)).
- From the thermal Eqs. (1) to (3), it is evident that the state matrix $A(u)$ is always strictly diagonally dominant with negative diagonal entries, hence it is Hurwitz [8].

C. Green Scheduling for Peak Demand Reduction

Though radiant systems have the capability to flatten out peaks in energy demand, the intermittent operation of the circulation pump causes significant fluctuations in the electricity demand, hence neutralizes this peak demand reduction benefit for a single zone. Furthermore, in a system of multiple zones, temporally correlated energy demand spikes can occur when multiple circulation pumps are activated simultaneously. This phenomenon will be demonstrated in the simulation in Section V, particularly in Fig. 8.

As we discussed in Section I, high peaks in electricity demand can be costly for commercial electricity customers. Therefore, it is desirable to reduce the peak aggregated electricity demand of the pumps, which must be achieved through coordination of the pumps' operations. At the same time, thermal comfort must be maintained in all the zones, specifically the zone temperature T_i should be kept within a comfortable range $[l_i, h_i]$ where $l_i < h_i$ are given. In our previous work [6], we proposed Green Scheduling as an approach for reducing peak energy demand. Essentially, in Green Scheduling, *multiple interacting control systems are coordinated within a constrained peak demand envelope while ensuring that safety and operational conditions are facilitated*. The peak demand envelope is formulated as a constraint on the number of binary control inputs that can be activated simultaneously, that is $\sum_{i=1}^n u_i(t) \leq k \forall t \geq 0$ for some given $k \in \{0, 1, \dots, n\}$. Evidently, this approach can be applied to coordinate the intermittent operations of the pumps, as stated in the following problem.

Problem 1: Given model (4) of the radiant system, comfort regions $[l_i, h_i]$ for $i = 1, \dots, n$, and peak constraint $0 \leq k \leq n$, schedule the operations of the circulation pumps so that the peak demand constraint is satisfied at all time while thermal comfort in each zone is maintained.

A control signal $u(\cdot)$ can be thought of as a schedule that switches on-off and coordinates the individual sub-systems. Hence, we will use interchangeably the terms *control signal* and *schedule*, and the terms *controller* and *scheduler*.

III. STATE FEEDBACK GREEN SCHEDULING

Periodic scheduling was utilized in our previous work [6] for Green Scheduling. While being simple and scalable, periodic scheduling does not take into account the influence of disturbances nor feedback information from the plant, hence it is unsuitable when large disturbances are present. In this section, we will develop a state feedback Green Scheduling strategy that can handle large disturbances.

We first define several essential notions. Consider the dynamical system in Eq. (4). In practice, the disturbances d are always bounded. Therefore, we assume that d is constrained in a convex and compact subset \mathcal{D} . The peak demand constraint k on the control inputs u is generalized as a non-empty finite constraint set $\mathcal{U} \subseteq \{0, 1\}^n$ of valid control inputs, meaning that $u(t) \in \mathcal{U}$ for all $t \geq 0$. When u is constrained by k , $\mathcal{U} := \{u \in \{0, 1\}^n : \|u\|_1 \leq k\}$.

A disturbance signal $d(\cdot)$ is *admissible* if it satisfies $d(t) \in \mathcal{D} \forall t \geq 0$. Similarly, an admissible control signal $u(\cdot)$ satisfies $u(t) \in \mathcal{U} \forall t \geq 0$. Given admissible signals $d(\cdot)$ and $u(\cdot)$, a state trajectory $x(\cdot)$ of the system is a continuous signal that satisfies Eq. (4) at all time. For any initial state $x(0) \in \mathbb{R}^n$, the state trajectory $x(\cdot)$ exists and is unique [9].

Because we are only interested in the zone temperatures, let us define the output vector $y = [T_1, \dots, T_n]^T$. Obviously $y = Cx$ with an appropriate matrix $C \in \mathbb{R}^{n \times 2n}$. Let $\text{Safe} \subset \mathbb{R}^n$ denote a compact set of safe, or desired, outputs of the system. For the radiant system in Section II, Safe specifies the desired zone temperature ranges: $\text{Safe} := [l_1, h_1] \times \dots \times [l_n, h_n]$. Our goal is to devise a scheduling strategy so that

from any initial state $x(0)$, the output $y(\cdot)$ is always driven to Safe in finite time and is maintained inside Safe indefinitely, regardless of the disturbances. Such an output trajectory is said to be (*eventually always*) *safe* and is defined below.

Definition 1: An output trajectory $y(\cdot)$ is (eventually always) safe if there exists a finite time $0 \leq \tau < +\infty$ such that $y(t) \in \text{Safe}$ for all $t \geq \tau$.

A. State Feedback Scheduling Strategy

A state feedback scheduling strategy is a feedback law $\kappa : \mathcal{X} \rightarrow \mathcal{U}$. The resulting state trajectory $x(\cdot)$ satisfies the *closed-loop* differential equation $\dot{x}(t) = A(\kappa(x(t)))x(t) + B\kappa(x(t)) + Wd(t)$, $\forall t \geq 0$, with initial state $x(0)$. To solve Problem 1, we aim to find a feedback law such that from any initial state and for any admissible disturbance signal, the resulting output trajectory is safe. Such a feedback law is called a *safe feedback law* (or *safe feedback scheduling strategy*). To this end, we use the concept of *attracting sets* of control systems [10]. However, to satisfy the finite-time requirement in Definition 1, we modify the definition of attracting sets as follows.

Definition 2: A set $\mathcal{A} \subset \mathcal{X}$ is a (finite-time) attracting set of control system (4) and a set $\mathcal{B} \subseteq \mathcal{X}$ is a basin of attraction of \mathcal{A} if there exists a feedback law $\kappa : \mathcal{X} \rightarrow \mathcal{U}$ such that for any initial state $x(0) \in \mathcal{B}$ and any admissible disturbance signal $d(\cdot)$, the resulting state trajectory $x(\cdot)$ satisfies $x(t) \in \mathcal{A}$, $\forall t \geq \tau$ for some finite $\tau \geq 0$.

It is readily seen that if an attracting set \mathcal{A} satisfies $C\mathcal{A} = \{Cx : x \in \mathcal{A}\} \subseteq \text{Safe}$ then there exists a safe state feedback scheduling strategy for all $x(0) \in \mathcal{B}$. The following result allows us to determine an attracting set of control system (4) and an associated safe feedback law.

Theorem 1: Let $x_c \in \mathcal{X}$ be a given point. Suppose there exist $M \in \mathbb{R}^{2n \times 2n}$, $\lambda > 0$ and $\alpha > 0$ such that

$$M \succeq C^T C, \quad M \succ 0, \quad (5a)$$

$$A(u)^T M + M A(u) \preceq -2\lambda M \quad \forall u \in \mathcal{U}, \quad (5b)$$

$$\alpha > \frac{1}{\lambda} \max_{z^T M z = 1} \min_{u \in \mathcal{U}} \max_{d \in \mathcal{D}} z^T M (A_0 x_c + \hat{B}u + Wd) \quad (5c)$$

where $\hat{B} = [b_1 + A_1 x_c, \dots, b_n + A_n x_c]$ and b_i is the i^{th} column of B . Then $\mathcal{A} := \{x \in \mathbb{R}^n : (x - x_c)^T M (x - x_c) \leq \alpha^2\}$ is an attracting set of control system (4) with basin $\mathcal{B} = \mathcal{X}$ and with state feedback law $\kappa(\cdot)$ given by

$$\kappa(x) = \arg \min_{u \in \mathcal{U}} (x - x_c)^T M \hat{B}u, \quad \forall x \in \mathcal{X}. \quad (6)$$

In addition, if the ball $\mathfrak{B}(Cx_c, \alpha) = \{y : \|y - Cx_c\|_2 \leq \alpha\}$ is a subset of Safe then $\kappa(\cdot)$ is a safe state feedback law.

Due to the page limit, the proof of Theorem 1 is omitted. M and λ satisfying Eqs. (5a) and (5b) can be computed by solving a Generalized Eigenvalue Problem (GEVP) [11], e.g., using the function `gevp` of the Robust Control Toolbox of MATLAB [12]. We remark that the function $V(x) := (x - x_c)^T M (x - x_c)$ is a robust control Lyapunov function of the control system [13]. Eq. (5c) essentially means that for any x outside \mathcal{A} , i.e., $V(x) > \alpha^2$, $u = \kappa(x)$ is such that, for all $d \in \mathcal{D}$, V always decays along the system's flow at a rate not slower than $-\gamma$, for some constant $\gamma > 0$. A detailed argument can be found in [14].

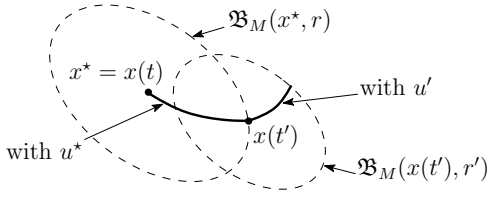

Fig. 3: Illustration of the event-based scheduling strategy.

Theorem 1 immediately gives us a safe feedback scheduling strategy. Note that we only need to re-compute u when x is outside \mathcal{A} . Once x is inside \mathcal{A} , we can simply keep the current control vector u until x hits the boundary of \mathcal{A} . Therefore, a basic feedback scheduling strategy is given by

$$u(t) = \begin{cases} \arg \min_{u \in \mathcal{U}} (x(t) - x_c)^T M \hat{B} u & \text{if } V(x(t)) \geq \alpha^2 \\ u(t^-) & \text{otherwise} \end{cases} \quad (7)$$

in which $u(t^-)$ denotes the currently used control vector. We note that M , x_c and α are pre-computed and fixed.

The basic scheduling strategy has several limitations:

- 1) It requires solving the minimization (7) continuously in real time, which is impractical.
- 2) It usually results in a high-frequency sliding mode control signal [15], when u switches rapidly and repeatedly between control vectors u' and u'' , causing x to slide along the boundary of two regions of state: one in which u' is optimal and the other in which u'' is optimal. This effect is often undesirable in practice.

IV. EVENT-BASED GREEN SCHEDULING

To overcome the aforementioned limitations of the basic feedback law, we will develop in this section an event-based scheduling strategy based on the basic strategy.

Consider any x outside \mathcal{A} . The feedback law in Eq. (7) essentially finds a control that always reduces $V(x(t))$ at the fastest rate possible. However, it is certainly sufficient to use a control that reduces $V(x(t))$ at a rate not slower than $-\gamma$. That is, as long as the current control, denoted u^* , satisfies $\max_{d \in \mathcal{D}} \dot{V}(x(t)) \leq -\gamma$ then we do not need to compute and switch to a new control. This observation leads to an event-triggered scheme where we only switch the control when it does not satisfy the previous inequality at the current state.

Define the norm $\|x\|_M := \sqrt{x^T M x}$. Let t be the current time and $x^* = x(t)$ be the current state. Instead of solving the optimization $\max_{d \in \mathcal{D}} \dot{V}(x(t))$ continuously in real time, we find a ball $\mathfrak{B}_M(x^*, r) := \{x : \|x - x^*\|_M \leq r\}$ with radius $r > 0$ around x^* so that for all $x \in \mathfrak{B}_M(x^*, r)$,

$$\max_{d \in \mathcal{D}} \dot{V} = \max_{d \in \mathcal{D}} 2(x - x_c)^T M (A(u^*)x + Bu^* + Wd) \leq -\gamma. \quad (8)$$

Once r is determined, we can keep $u(t') = u^*$ for $t' \geq t$ as long as $x(t') \in \mathfrak{B}_M(x^*, r)$ and only compute a new control by Eq. (7) when the event $\|x(t') - x^*\|_M \geq r$ is detected. This event-triggered scheme is illustrated in Fig. 3. The radius r can be estimated using the following propositions.

Proposition 1: The radius r is bounded below by

$$r_1 = \beta + \frac{1}{2} \left(\xi - \sqrt{\xi^2 + 4\beta\xi + \frac{4\theta}{\lambda} + \frac{2\gamma}{\lambda}} \right) \quad (9)$$

where $\theta = \max_{d \in \mathcal{D}} (x^* - x_c)^T M (A(u^*)x_c + Bu^* + Wd)$, $\beta = \|x^* - x_c\|_M$, $\xi = \frac{1}{\lambda} \max_{d \in \mathcal{D}} \|A(u^*)x_c + Bu^* + Wd\|_M$.

TABLE II: Parameter values for a zone in the simulation.

Space length, width, height: 6 m × 6 m × 3 m	
External/internal pipe diameter: 20/15 mm	
Mass flow rate (per slab area): 15 kg/(h m ²)	
1/ K_{ij} (only for adjacent zones): [0.16, 0.20] (K m ² /W)	
Desired zone temperature range: [22, 26] (°C)	
Façade area: 18 m ²	Internal-wall area: 36 m ²
Thickness of concrete slab: 250 mm	Pipe spacing: 200 mm
1/ $K_{w,i} \in [0.05, 0.07]$ (K m ² /W)	1/ $K_i \in [2.1, 2.2]$ (K m ² /W)
1/ $K_{r,i} \in [0.124, 0.130]$ (K m ² /W)	$T_{w,i} = 18$ °C
$C_i \in [1900, 2100]$ (kJ/K)	$C_{r,i} \in [3000, 4000]$ (kJ/K)

Proposition 2: The radius r is bounded below by

$$r_2 = - \frac{\gamma/2 + \zeta}{\|(R^{-1})^T A^T M (x^* - x_c)\|_2 + \chi} \quad (10)$$

in which nonsingular upper-triangular matrix R satisfying $R^T R = M$ is determined by the Cholesky decomposition of M , $\zeta = \max_{d \in \mathcal{D}} (x^* - x_c)^T M (A(u^*)x^* + Bu^* + Wd)$, and $\chi = \max_{d \in \mathcal{D}} \|A(u^*)x^* + Bu^* + Wd\|_M$.

Although Eq. (10) has a negation sign, it is usually the case that $\zeta < -\gamma/2$, hence r_2 is usually positive. The radius r is then estimated as the larger value of r_1 and r_2 . Note that M , λ , γ , x_c , u^* , and x^* are all fixed. Thus the optimization programs involved in those results are convex quadratic and linear programs, which can be solved efficiently.

A. Improved Scheduling with Disturbance Prediction

If short-term disturbance predictions are available, they can be utilized to improve Green Scheduling. Specifically, suppose that at any time $t \geq 0$, a prediction of the disturbance constraint set can be obtained for a finite time horizon $h > 0$, that is $d(\tau) \in \mathcal{D}_{[t, t+h]} \forall \tau \in [t, t+h]$, where $\mathcal{D}_{[t, t+h]}$ is known and is not larger than \mathcal{D} . Then the event-based scheduling strategy can be modified to exploit this information by replacing \mathcal{D} by $\mathcal{D}_{[t, t+h]}$ in calculations of r_1 and r_2 , which often results in larger estimates of r ;

V. SIMULATION EXAMPLE

We consider a building of 10 zones of equal size. Five of them face north while the other five face south. The building is cooled by a hydronic radiant cooling system with the same configuration as described in Section II and illustrated in Fig. 1. The supply water temperature is the same for all zones and is fixed at a predetermined value T_w .

For each zone, we used the parameter values from [7] for a typical office building, which are summarized in Table II. Because the parameters in [7] are for a single zone, while the considered building has 10 zones, we varied several parameter values for each zone uniformly randomly around the nominal values in [7]. The ranges for these parameters are also reported in Table II. For the corner zones that have two external walls, we increased K_i accordingly. The comfort range of zone temperature is 22 °C to 26 °C for all zones.

A. Disturbances

We assume that weather forecasts give us the ranges of T_a and $q_{s,i}$ for each zone i at any given time during the day. The constraint of $q_{g,i}$ for each zone i can be calculated

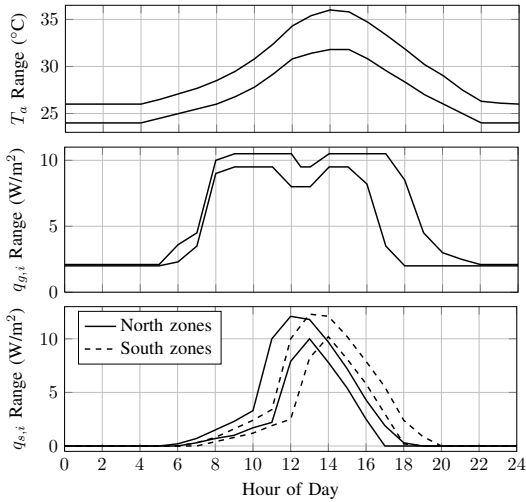

Fig. 4: Time-varying constraints of the disturbances T_a (top), $q_{g,i}$ (middle) and $q_{s,i}$ (bottom) affecting each zone.

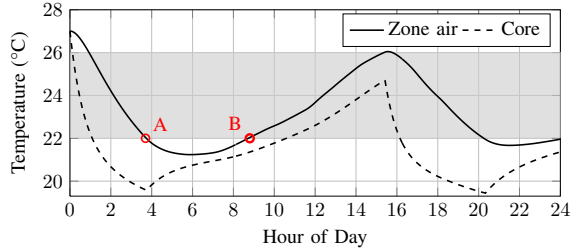

Fig. 5: Air and core temperatures of zone 1 for the unsafe uncoordinated intermittent operation.

based on the power rates of the equipment and lights in the zone as well as its occupants' schedules. In this example, the time-varying constraints of T_a , $q_{g,i}$ and $q_{s,i}$, for every $i \in \{1, \dots, 10\}$, are given in Fig. 4. Note that between the north zones and the south zones, their solar radiation heat gain profiles are different, as clearly displayed in Fig. 4. Each disturbance signal for each zone was then generated uniformly randomly within its given time-varying constraint.

B. Uncoordinated Intermittent Operation

We considered the uncoordinated intermittent operation of the pumps as the baseline. For each zone i , its pump is switched on/off with hysteresis independently of the other zones as follows: whenever $T_i \geq 26^\circ\text{C}$, $u_i = 1$; whenever $T_i \leq 22^\circ\text{C}$, $u_i = 0$. This simple control strategy was simulated in MATLAB for 24 hours. The initial temperatures for all zones were set to 27°C . The resulting air temperature T_1 and core temperature $T_{c,1}$ of zone 1 are plotted in Fig. 5.

As obviously seen in Fig. 5, T_1 dropped below 22°C , to as low as about 21°C , twice during the day. For example, between points A and B in Fig. 5, T_1 was below 22°C for more than 5 hours. This phenomenon can be explained by the high thermal inertia of the radiant system. When the pump was switched off (point A), the slab stopped being cooled; however the core temperature was still significantly below the zone temperature, causing the air to continue being cooled.

To avoid this issue, we increased the pumps' switching-off thresholds by 1.15°C to 23.15°C . The new simulation

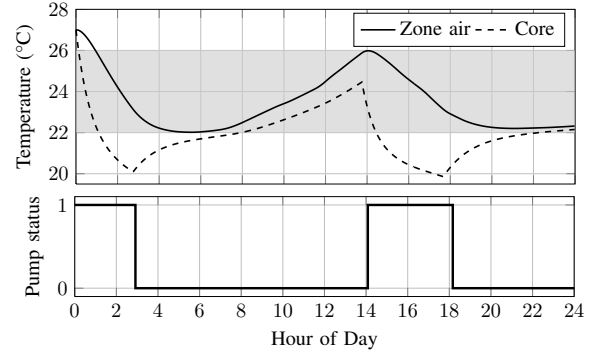

Fig. 6: Temperatures (top) and pump's status (bottom) of zone 1 for the safe uncoordinated intermittent operation.

results are reported in Fig. 6. Clearly T_1 was driven to and maintained within the desired range (gray-filled area).

Because the pumps' power information was not provided in [7], we assumed a normalized power demand of 1 (power unit) for each pump. Fig. 8 shows the normalized total power demand of the pumps (dashed line). Evidently, the demand fluctuated significantly during the day and attained a high peak of 9 during the on-peak hours between 3:30 PM and 5:45 PM. A high peak of 10 was attained before 3:00 AM due to the uncoordinated initialization of the zonal controllers. Thus, under a demand-based electricity tariff, it would incur a high demand cost. The total energy consumption of the pumps was 62.5 (power unit \times hour).

C. Event-based Green Scheduling

To flatten out the high peak demand incurred by the uncoordinated intermittent operation, the event-based Green Scheduling strategy was applied. We assumed that at any time, one-hour predictions of the disturbance constraints were available to the scheduler. Therefore, we used the improved scheduling strategy with disturbance prediction, presented in Section IV-A. The peak constraint on the control inputs was chosen to be $k = 2$ at all time. A MATLAB simulation was performed for 24 hours with the same disturbance profiles and the same initial temperatures as in Section V-B. Fig. 7 plots the simulation results. It is clear that T_1 was safe as it was driven to and maintained inside the desired range (gray-filled area). Compared to the uncoordinated scheduling, the pump of zone 1 was switched on and off twice as often, however its switching frequency was still slow (less than once every 3 hours). Each iteration of the event-based scheduling algorithm took an average of about 16 ms on MATLAB on a MacbookPro computer with 2.26 GHz Core 2 Duo processor and 4 GB RAM.

The total power demand of the pumps is plotted in Fig. 8 in comparison with that for the uncoordinated operation. Evidently, the peak demand was flattened out and significantly reduced. In fact, the demand of Green Scheduling was constant at 2 for most of the day. The normalized peak demand and total energy consumption of both scheduling strategies are compared in Table III. Note that we only report the peaks during the on-peak hours. By applying Green Scheduling, we saved 77.8% in peak demand and 31.2% in

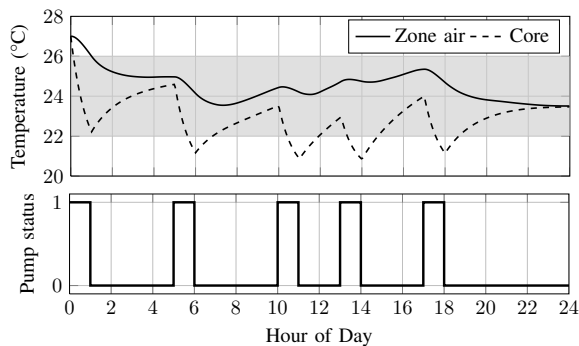

Fig. 7: Temperatures (top) and pump’s status (bottom) of zone 1 for the event-based Green Scheduling algorithm.

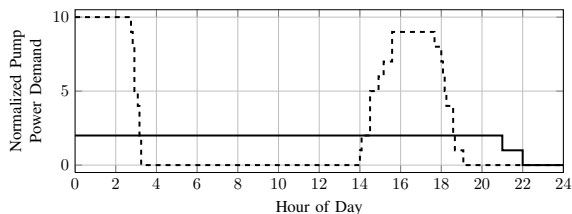

Fig. 8: Normalized total power demand for Green Scheduling (solid) and uncoordinated scheduling (dashed) strategies.

total energy consumption. Under a demand-based electricity tariff, this would amount to a large saving in electricity cost.

VI. RELATED WORK

There are various approaches to balance the power consumption in buildings and to flatten out peaks in power demand, e.g., load shifting and load shedding [16]. However, they operate on coarse grained time scales and do not guarantee any thermal comfort. Model Predictive Control (MPC) has received increasing attention in energy efficient control and peak electricity demand reduction for commercial buildings [17], [18]. Although MPC can be used for the Green Scheduling problem, the combinatorial nature of the control inputs usually results in mixed integer programs, which can be expensive computationally to solve. Hence we opted for a simple scheduling approach in this paper.

Essentially, the Green Scheduling problem is a safe control problem for switched systems [19]. There has been a vast literature on safe switching controller synthesis for switched systems (see e.g., [20]). However, most of these synthesis methods are not scalable in terms of the number of discrete modes and the dimension of the state space.

Event-triggering has been used in control theory since the end of the nineties for efficient implementations of control laws in situations where limited resources, such as actuation and network communication, are shared among several subsystems [21]. Similar to this paper, control Lyapunov

TABLE III: Normalized peak demand and total energy consumption of both scheduling strategies.

	Peak	Consumption
Uncoordinated scheduling	9	62.5
Green Scheduling	2 (-77.8%)	43 (-31.2%)

functions were usually used in the literature for deriving the event-triggering conditions.

VII. CONCLUSION

In this paper, we developed an event-based state feedback scheduling strategy for the Green Scheduling problem. Unlike the periodic scheduling approach used in our previous work, this new scheduling algorithm directly takes into account the influence of disturbances. It was applied to scheduling intermittent operations of pumps of hydronic radiant systems, and was shown through simulations in MATLAB to be effective for reducing the peak electricity demand of the pumps.

For future work, we aim to develop distributed and hierarchical scheduling algorithms for peak demand reduction in extremely large systems. We are also investigating scheduling strategies based on dynamic pricing models that can lead to demand cost reduction in a more on-line fashion.

REFERENCES

- [1] R. Watson and K. Chapman, *Radiant Heating and Cooling Handbook*, ser. McGraw-Hill Handbooks. McGraw-Hill, 2002.
- [2] D. Saelens, W. Parys, and R. Baetens, “Energy and comfort performance of thermally activated building systems including occupant behavior,” *Building & Environment*, vol. 46, no. 4, pp. 835–848, 2011.
- [3] B. Olesen, “Radiant floor heating in theory and practice,” *ASHRAE Journal*, vol. 44, no. 7, pp. 19–24, 2002.
- [4] T. Y. Chen, “Application of adaptive predictive control to a floor heating system with a large thermal lag,” *Energy and Buildings*, vol. 34, no. 1, pp. 45–51, 2002.
- [5] M. Gwerder, J. Tödtli, B. Lehmann, V. Dorer, W. Güntensperger, and F. Renggli, “Control of thermally activated building systems (TABS) in intermittent operation with pulse width modulation,” *Applied Energy*, vol. 86, no. 9, pp. 1606–1616, 2009.
- [6] T. X. Nghiem, M. Behl, G. J. Pappas, and R. Mangharam, “Green scheduling for radiant systems in buildings,” in *IEEE CDC*, 2012.
- [7] M. Gwerder, B. Lehmann, J. Tödtli, V. Dorer, and F. Renggli, “Control of thermally activated building systems (TABS),” *Applied Energy*, vol. 85, pp. 565–581, 2008.
- [8] R. A. Horn and C. R. Johnson, *Matrix analysis*. Cambridge University Press, 1990.
- [9] W. J. Rugh, *Linear System Theory*. Prentice-Hall, 1996.
- [10] H. K. Khalil, *Nonlinear systems*. Macmillan New York, 1992.
- [11] S. Boyd, L. E. Ghaoui, E. Feron, and V. Balakrishnan, *Linear matrix inequalities in system and control theory*. SIAM, 1994.
- [12] The MathWorks, “Robust control toolbox,” 2012.
- [13] Z. Artstein, “Stabilization with relaxed controls,” *Nonlinear Analysis: Theory, Methods & Applications*, vol. 7, no. 11, pp. 1163–1173, 1983.
- [14] T. X. Nghiem, “Green scheduling of control systems,” Ph.D. dissertation, University of Pennsylvania, 2012.
- [15] C. Edwards and S. Spurgeon, *Sliding Mode Control: Theory And Applications*. Taylor & Francis, 1998.
- [16] K. ho Lee and J. E. Braun, “Development of methods for determining demand-limiting setpoint trajectories in buildings using short-term measurements,” *Building & Environment*, vol. 43, no. 10, 2008.
- [17] Y. Ma, F. Borrelli, B. Hency, B. Coffey, S. Bengesa, and P. Haves, “Model predictive control for the operation of building cooling systems,” in *Proc. ACC*, 2010, pp. 5106–5111.
- [18] F. Oldewurtel, A. Ulbig, A. Parisio, G. Andersson, and M. Morari, “Reducing peak electricity demand in building climate control using real-time pricing and model predictive control,” in *Proceedings of the IEEE Conference on Decision and Control*, 2010, pp. 1927–1932.
- [19] H. Lin and P. J. Antsaklis, “Stability and stabilizability of switched linear systems: A survey of recent results,” *IEEE Trans. Autom. Control*, vol. 54, no. 2, pp. 308–322, 2009.
- [20] E. Asarin, O. Bournez, T. Dang, O. Maler, and A. Pnueli, “Effective synthesis of switching controllers for linear systems,” *Proc. IEEE*, vol. 88, no. 7, pp. 1011–1025, 2000.
- [21] P. Tabuada, “Event-triggered real-time scheduling of stabilizing control tasks,” *IEEE Trans. Autom. Control*, vol. 52, no. 9, 2007.